

CONDITIONAL ZONING TOWN OF
APPLICATION 405 Martin Luther King Jr.



CHAPEL HILL Planning Department

Blvd.

(919) 968-2728

fax (919) 969-2014 www.townofchapelhill.org

Parcel Identifier Number (PIN): 9788-03-2946 /0899/0940

Date: September 7, 2021

Section A: Project Information

Project Name: P.E.A.C.H. Apartments
Property Address: 107 & 107 A/B Johnson Street Zip Code: 27516
Use Groups (A, B, and/or C): A Existing Zoning District:
Project Description: Construct ten (10) affordable dwelling units

Section B: Applicant, Owner, and/or Contract Purchaser Information

Applicant Information (to whom correspondence will be mailed):

Name: EMPOWERment Inc..
Address: 109 N. Graham St
City: Chapel Hill State: NC Zip Code: 27516
Phone: 919-967-8779 Email: delores.bailey@gmail.com

The undersigned applicant hereby certifies that, to the best of their knowledge and belief, all information supplied with this application and accurate.

Signature: Delores M Bailey Date: 9/27/21

Owner/Contract Purchaser Information:

Owner

Contract Purchaser

Name: EMPOWERment, Inc
Address: 109 N Graham Street
City: Chapel Hill State: NC Zip Code: 27516
Phone: 919-967-8779 Email: delores.bailey@gmail.com

The undersigned applicant hereby certifies that, to the best of their knowledge and belief, all information supplied with this application and accurate.

Signature: Delores M. Bailey Date: 9/27/21

Click [here](#) for application submittal instructions.



CONDITIONAL ZONING

TOWN OF CHAPEL HILL
Planning Department

Conditional Rezoning applications are reviewed by staff, Planning Commission, and Town Council. The application is part of an open public process that enables Town Council to discuss and decide on the key issues of a rezoning proposal. If a rezoning is approved, the applicant may then submit a detailed final plan application to staff for compliance review with the technical development standards and with the Council rezoning approval.

The establishment of a Conditional Zoning District shall be consistent with the Land Use Plan in the Comprehensive Plan. A proposed Conditional Zoning District is deemed consistent if the proposed District will be located in conformance with an adopted small area plan and/or in one of the following Land Use Categories:

- Medium Residential
- High Residential
- Commercial
- Mixed Use, Office/Commercial Emphasis
- Mixed Use, Office Emphasis
- Town/Village Center
- Institutional
- Office
- University
- Development Opportunity Area
- Light Industrial Opportunity Area

If the proposed conditional zoning districts is located in a Low Residential or a Rural Residential Land Use Category, the Town Council must approve a Land Use Plan amendment prior to proceeding.

SIGNED CONDITIONS: All conditions shall be in writing, prepared by the owner of the property or an attorney and must be signed by all property owners and contract purchasers, if applicable. The Town Attorney may require additional signatures if necessary and will determine whether or not the conditions statement is legally sufficient. Within thirty (30) days after receipt of the conditions the Planning Division Manager will notify the applicant of any deficiencies in the conditions statement or if any additional information is needed. The applicant may make changes to the written conditions statement provided it is submitted at least thirty (30) prior to Planning Commission meeting or thirty (30) days prior to Town Council public hearing.

RECORDATION OF CONDITIONS: After a rezoning has been approved by the Town Council, the conditions statement shall be recorded with the Register of Deeds Office. After a rezoning has been approved by Town Council and recorded by the Register of Deeds Office, the conditions may not be amended except through a new rezoning application.



PROJECT FACT SHEET

TOWN OF CHAPEL HILL

Planning Department

Section A: Project Information

Use Type: (check/list all that apply)

Office/Institutional Residential Mixed-Use Other: _____

Overlay District: (check all that apply)

Historic District Neighborhood Conservation District Airport Hazard Zone

Section B: Land Area

Net Land Area (NLA): Area within zoning lot boundaries		NLA=	29,258	sq. ft.
Choose one, or both, of the following (a or b), not to exceed 10% of NLA	a) Credited Street Area (total adjacent frontage) x ½ width of public right-of-way	CSA=	2,926	sq. ft.
	b) Credited Permanent Open Space (total adjacent frontage) x ½ public or dedicated open space	COS=	0	sq. ft.
TOTAL: NLA + CSA and/or COS = Gross Land Area (not to exceed NLA + 10%)		GLA=	32,164	sq. ft.

Section C: Special Protection Areas, Land Disturbance, and Impervious Area

Special Protection Areas: (check all those that apply)

Jordan Buffer Resource Conservation District 100 Year Floodplain Watershed Protection District

Land Disturbance	Total (sq. ft.)
Area of Land Disturbance (Includes: Footprint of proposed activity plus work area envelope, staging area for materials, access/equipment paths, and all grading, including off-site clearing)	23,399
Area of Land Disturbance within RCD	0
Area of Land Disturbance within Jordan Buffer	0

Impervious Areas	Existing (sq. ft.)	Demolition (sq. ft.)	Proposed (sq. ft.)	Total (sq. ft.)
Impervious Surface Area (ISA)	5,141	5,141	11,508	11,508
Impervious Surface Ratio: Percent Impervious Surface Area of Gross Land Area (ISA/GLA)%	15.98	15.98	35.8	35.8
If located in Watershed Protection District, % of impervious surface on 7/1/1993	15.98	15.98	35.8	35.8



PROJECT FACT SHEET

TOWN OF CHAPEL HILL

Planning Department

Section D: Dimensions

Dimensional Unit (sq. ft.)	Existing (sq. ft.)	Demolition (sq. ft.)	Proposed (sq. ft.)	Total (sq. ft.)
Number of Buildings	1,608	1, 608	7,697	7,697
Number of Floors	one	one	two	two
Recreational Space	3,980	3,980	2,002	2,002

Residential Space

Dimensional Unit (sq. ft.)	Existing (sq. ft.)	Demolition (sq. ft.)	Proposed (sq. ft.)	Total (sq. ft.)
Floor Area (all floors – heated and unheated)	1,608	1,608	7,697	7,697
Total Square Footage of All Units	0	0	7,697	7,697
Total Square Footage of Affordable Units	0	0	7,697	7,697
Total Residential Density	None	None	13.5	13.5
Number of Dwelling Units	None	None	10	10
Number of Affordable Dwelling Units	None	None	10	10
Number of Single Bedroom Units	None	None	6	6
Number of Two Bedroom Units	None	None	3	3
Number of Three Bedroom Units	None	None	1	1

Non-Residential Space (Gross Floor Area in Square Feet)

Use Type	Existing	Proposed	Uses	Existing	Proposed
Commercial					
Restaurant			# of Seats		
Government					
Institutional	1,608	None			
Medical					
Office					
Hotel			# of Rooms		
Industrial					
Place of Worship			# of Seats		
Other					

Dimensional Requirements		Required by Ordinance	Existing	Proposed
Setbacks (minimum)	Street	10	27.7	36
	Interior (neighboring property lines)	0	7.6	26.2
	Solar (northern property line)	0	27.7	36
Height (maximum)	Primary	None	None	None
	Secondary	60	19	32.05
Streets	Frontages	None	194	194
	Widths	None	193	193



PROJECT FACT SHEET

TOWN OF CHAPEL HILL

Planning Department

Section F: Adjoining or Connecting Streets and Sidewalks

Note: For approval of proposed street names, contact the Engineering Department.

Street Name	Right-of-Way Width	Pavement Width	Number of Lanes	Existing Sidewalk*	Existing Curb/Gutter
Johnson Street	40	27	Two	<input type="checkbox"/> Yes	<input checked="" type="checkbox"/> Yes
				<input type="checkbox"/> Yes	<input type="checkbox"/> Yes

List Proposed Points of Access (Ex: Number, Street Name):

*If existing sidewalks do not exist and the applicant is adding sidewalks, please provide the following information:

Sidewalk Information			
Street Names	Dimensions	Surface	Handicapped Ramps
			<input type="checkbox"/> Yes <input type="checkbox"/> No <input type="checkbox"/> N/A
			<input type="checkbox"/> Yes <input type="checkbox"/> No <input type="checkbox"/> N/A

Section G: Parking Information

Parking Spaces	Minimum	Maximum	Proposed
Regular Spaces	11	13	11
Handicap Spaces	1	1	2
Total Spaces	12	15	13
Loading Spaces	NA	NA	NA
Bicycle Spaces	2.5	2.5	4
Surface Type	Asphalt		

Section H: Landscape Buffers

Location (North, South, Street, Etc.)	Minimum Width	Proposed Width	Alternate Buffer	Modify Buffer
North	15	15	<input type="checkbox"/> Yes	<input type="checkbox"/> Yes
East	0	5	<input type="checkbox"/> Yes	<input type="checkbox"/> Yes
South	0	20	<input type="checkbox"/> Yes	<input type="checkbox"/> Yes
West	0	23	<input type="checkbox"/> Yes	<input type="checkbox"/> Yes



Section I: Land Use Intensity

Existing Zoning District:
 Proposed Zoning Change (if any):

Zoning – Area – Ratio			Impervious Surface Thresholds			Minimum and Maximum Limitations	
Zoning District(s)	Floor Area Ratio (FAR)	Recreation Space Ratio (RSR)	Low Density Residential (0.24)	High Density Residential (0.50)	Non-Residential (0.70)	Maximum Floor Area (MFA) = FAR x GLA	Minimum Recreation Space (MSR) = RSR x GLA
R-SS-CZD	1.1	.05	7,719	16,082		35,380	1,608
TOTAL							
RCD Streamside		0.01					
RCD Managed		0.019					
RCD Upland							

Section J: Utility Service

Check all that apply:

Water	<input checked="" type="checkbox"/> OWASA	<input type="checkbox"/> Individual Well	<input type="checkbox"/> Community Well	<input type="checkbox"/> Other
Sewer	<input checked="" type="checkbox"/> OWASA	<input type="checkbox"/> Individual Septic Tank	<input type="checkbox"/> Community Package Plant	<input type="checkbox"/> Other
Electrical	<input checked="" type="checkbox"/> Underground	<input type="checkbox"/> Above Ground		
Telephone	<input checked="" type="checkbox"/> Underground	<input type="checkbox"/> Above Ground		
Solid Waste	<input checked="" type="checkbox"/> Town	<input type="checkbox"/> Private		



**CONDITIONAL ZONING APPLICATION
SUBMITTAL REQUIREMENTS**
TOWN OF CHAPEL HILL
Planning Department

The following must accompany your application. Failure to do so will result in your application being considered incomplete. For assistance with this application, please contact the Chapel Hill Planning Department (Planning) at (919) 968-2728 or at planning@townofchapelhill.org.

Stormwater Impact Statement (1 copy to be submitted)

X	Application fee (including Engineering Review fee) (refer to fee schedule)	Amount Paid \$	0.00
x	Pre-application meeting –with appropriate staff		
x	Digital Files – provide digital files of all plans and documents		
x	Recorded Plat or Deed of Property		
x	Project Fact Sheet		
Exemp	Traffic Impact Statement – completed by Town’s consultant (or exemption)		
NA	Description of Public Art Proposal , if applicable		
x	Statement of Justification		
x	Response to Community Design Commission and Town Council Concept Plan comments , if applicable		
x	Affordable Housing Proposal , if applicable		
x	Statement of Consistency with Comprehensive Plan or request to amend Comprehensive Plan		
x	Mailing list of owners of property within 1,000 feet perimeter of subject property (see GIS notification tool)		
x	Mailing fee for above mailing list (mailing fee is double due to 2 mailings)	Amount Paid \$	0.00
x	Written Narrative describing the proposal, including proposed land uses and proposed conditions		
x	Resource Conservation District, Floodplain, & Jordan Buffers Determination – necessary for all submittals		

NA	Jurisdictional Wetland Determination – if applicable
NA	Resource Conservation District Encroachment Exemption or Variance (determined by Planning)
NA	Jordan Buffer Authorization Certificate or Mitigation Plan Approval (determined by Planning)
X	Reduced Site Plan Set (reduced to 8.5" x 11")

- a) Written narrative describing existing & proposed conditions, anticipated stormwater impacts and management structures and strategies to mitigate impacts
- b) Description of land uses and area (in square footage)
- c) Existing and proposed impervious surface area in square feet for all subareas and project area
- d) Ground cover and uses information
- e) Soil information (classification, infiltration rates, depth to groundwater and bedrock)
- f) Time of concentration calculations and assumptions
- g) Topography (2-foot contours)
- h) Pertinent on-site and off-site drainage conditions
- i) Upstream and/or downstream volumes
- j) Discharges and velocities
- k) Backwater elevations and effects on existing drainage conveyance facilities
- l) Location of jurisdictional wetlands and regulatory FEMA Special Flood Hazard Areas
- m) Water quality volume calculations
- n) Drainage areas and sub-areas delineated
- o) Peak discharge calculations and rates (1, 2, and 25-year storms)
- p) Hydrographs for pre- & post-development without mitigation, post-development with mitigation
- q) Volume calculations and documentation of retention for 2-year storm



**CONDITIONAL ZONING APPLICATION
SUBMITTAL REQUIREMENTS
TOWN OF CHAPEL HILL
Planning and Development Services**

- r) 85% TSS removal for post-development stormwater runoff
- s) Nutrient loading calculations
- t) BMP sizing calculations
- u) Pipe sizing calculations and schedule (include HGL & EGL calculations and profiles)

Plan Sets (10 copies to be submitted no larger than 24" x 36")

Plans should be legible and clearly drawn. All plan set sheets should include the following:

- Project Name
- Legend
- Labels
- North Arrow (North oriented toward top of page)
- Property boundaries with bearing and distances
- Scale (Engineering), denoted graphically and numerically
- Setbacks
- Streams, RCD Boundary, Jordan Riparian Buffer Boundary, Floodplain, and Wetlands Boundary, where applicable
- Revision dates and professional seals and signatures, as applicable

Cover Sheet

- a) Include Project Name, Project fact information, PIN, and Design Team
- a) Project name, applicant, contact information, location, PIN, & legend
- b) Dedicated open space, parks, greenways
- c) Overlay Districts, if applicable

Area Map

- d) Property lines, zoning district boundaries, land uses, project names of site and surrounding properties, significant buildings, corporate limit lines
- e) Existing roads (public & private), rights-of-way, sidewalks, driveways, vehicular parking areas, bicycle parking, handicapped parking, street names
- f) 1,000' notification boundary

Existing Conditions Plan

- a) Slopes, soils, environmental constraints, existing vegetation, and any existing land features
- b) Location of all existing structures and uses
- c) Existing property line and right-of-way lines
- d) Existing utilities & easements including location & sizes of water, sewer, electrical, & drainage lines
- e) Nearest fire hydrants
- f) Nearest bus shelters and transit facilities
- g) Existing topography at minimum 2-foot intervals and finished grade
- h) Natural drainage features & water bodies, floodways, floodplain, RCD, Jordan Buffers & Watershed boundaries



**CONDITIONAL ZONING APPLICATION
SUBMITTAL REQUIREMENTS
TOWN OF CHAPEL HILL
Planning and Development Services**

Detailed Site Plan

- a) Existing and proposed building locations
- b) Description & analysis of adjacent land uses, roads, topography, soils, drainage patterns, environmental constraints, features, existing vegetation, vistas (on and off-site)
- c) Location, arrangement, & dimension of vehicular parking, width of aisles and bays, angle of parking, number of spaces, handicapped parking, bicycle parking. Typical pavement sections & surface type.
- d) Location of existing and proposed fire hydrants
- e) Location and dimension of all vehicle entrances, exits, and drives
- f) Dimensioned street cross-sections and rights-of-way widths
- g) Pavement and curb & gutter construction details
- h) Dimensioned sidewalk and tree lawn cross sections
- i) Proposed transit improvements including bus pull-off and/or bus shelter
- j) Required landscape buffers (or proposed alternate/modified buffers)
- k) Required recreation area/space (including written statement of recreation plans)
- l) Refuse collection facilities (existing and proposed) or shared dumpster agreement
- m) Construction parking, staging, storage area, and construction trailer location
- n) Sight distance triangles at intersections
- o) Proposed location of street lights and underground utility lines and/or conduit lines to be installed
- p) Easements
- q) Clearing and construction limits

- r) Traffic Calming Plan – detailed construction designs of devices proposed & associated sign & marking plan

Stormwater Management Plan

- a) Topography (2-foot contours)
- b) Existing drainage conditions
- c) RCD and Jordan Riparian Buffer delineation and boundary (perennial & intermittent streams; note ephemeral streams on site)
- d) Proposed drainage and stormwater conditions
- e) Drainage conveyance system (piping)
- f) Roof drains
- g) Easements
- h) BMP plans, dimensions, details, and cross-sections
- i) Planting and stabilization plans and specifications

Landscape Protection Plan

- a) Rare, specimen, and significant tree survey within 50 feet of construction area
- b) Rare and specimen tree critical root zones
- c) Rare and specimen trees proposed to be removed
- d) Certified arborist tree evaluation, if applicable
- e) Significant tree stand survey
- f) Clearing limit line
- g) Proposed tree protection/silt fence location
- h) Pre-construction/demolition conference note
- i) Landscape protection supervisor note
- j) Existing and proposed tree canopy calculations, if applicable



**CONDITIONAL ZONING APPLICATION
SUBMITTAL REQUIREMENTS
TOWN OF CHAPEL HILL
Planning and Development Services**

Planting Plan

- a) Dimensioned and labeled perimeter buffers
- b) Off-site buffer easement, if applicable
- c) Landscape buffer and parking lot planting plan (including planting strip between parking and building, entryway planting, and 35% shading requirement)

Steep Slope Plan

- a) Classify and quantify slopes 0-10%, 10-15%, 15-25%, and 25% and greater
- b) Show and quantify areas of disturbance in each slope category
- c) Provide/show specialized site design and construction techniques

Grading and Erosion Control Plan

- a) Topography (2-foot contours)
- b) Limits of Disturbance
- c) Pertinent off-site drainage features

- d) Existing and proposed impervious surface tallies

Streetscape Plan, if applicable

- a) Public right-of-way existing conditions plan
- b) Streetscape demolition plan
- c) Streetscape proposed improvement plan
- d) Streetscape proposed utility plan and details
- e) Streetscape proposed pavement/sidewalk details
- f) Streetscape proposed furnishing details
- g) Streetscape proposed lighting detail

Solid Waste Plan

- a) Preliminary Solid Waste Management Plan
- b) Existing and proposed dumpster pads
- c) Proposed dumpster pad layout design
- d) Proposed heavy duty pavement locations and pavement construction detail
- e) Preliminary shared dumpster agreement, if applicable



CONDITIONAL ZONING APPLICATION SUBMITTAL REQUIREMENTS TOWN OF CHAPEL HILL Planning and Development Services

Construction Management Plan

- a) Construction trailer location
- b) Location of construction personnel parking and construction equipment parking
- c) Location and size of staging and materials storage area
- d) Description of emergency vehicle access to and around project site during construction
- e) Delivery truck routes shown or noted on plan sheets

Energy Management Plan

- a) Description of how project will be 20% more energy efficient than ASHRAE standards
- b) Description of utilization of sustainable forms of energy (Solar, Wind, Hydroelectric, and Biofuels)
- c) Participation in NC GreenPower program
- d) Description of how project will ensure indoor air quality, adequate access to natural lighting, and allow for proposed utilization of sustainable energy
- e) Description of how project will maintain commitment to energy efficiency and reduced carbon footprint over time

- f) Description of how the project's Transportation Management Plan will support efforts to reduce energy consumption as it affects the community

Exterior Elevations

- a) An outline of each elevation of the building, including the finished grade line along the foundation (height of building measured from mean natural grade)



ARCHITECT: JGA Architects
308 West Rosemary Street
Chapel Hill, NC

February 24, 2022

ENGINEER: Phil Post
Providence Rd.
Chapel Hill, NC

P.E.A.C.H. PROJECT

Request for a Modification to Regulations

To: Planning Staff
Town of Chapel Hill
Via: email to planning@townofchapelhill.org

It is important to this project that the occupants of PEACH be able to conveniently wait for ride-sharing and other public transit-friendly modalities. In a project in which all, or most, of the occupants are at 30% or less of AMI it is likely that automobile ownership will be low. Ride sharing, taxis (especially for the elderly) and EZ rider are all important components of a transit system that can effectively serve this population.

For these system components to work most effectively it is important to have a shelter that is close to the curb where people can wait in inclement weather. This shelter must be placed within the front yard setback to be close to the curb so that people can wait and enter the taxis, and EZ rider vehicles easily and without a lot of wait time for the transit vehicles.

Town regulations discourage structures within the front yard setback. The applicant strongly believes that an exception should be made here in order to advance the transit friendly attributes of this project. For this reason we are requesting a Modification to Regulations that will allow a shelter within the front yard setback for this CUZ.

Conditional Use Application

For:

P.E.A.C.H. AFFORDABLE RENTALS

A project of EMPOWERment, Inc.

107 Johnson Street

Chapel Hill, NC

Applicant:



EMPOWERment, Inc.

109 North Graham Street

Suite 200

Chapel Hill, NC 27516

Civil Engineer:

Philip Post Engineering
P.O.Box 4912
Chapel Hill, NC 27515

Architect:

JGA Josh Gurlitz Architecture
308 West Rosemary Street
Chapel Hill, NC 27516

<u>Issue Dates</u>	<u>Description</u>
July 28 2021	Conditional Use Submittal

Developer's Program

Project Description

About the developer:

EMPOWERment, Inc. EMPOWERment, Inc. has been providing a variety of affordable housing options for 25 years in the Chapel Hill community. These options have included rental opportunities in existing housing stock and affordable homes for purchase in new construction. P.E.A.C.H. will be the initial new rental project for EMPOWERment, Inc. and will be the first of future projects intended to help address the need for affordable rental housing in Chapel Hill.

About P.E.A.C.H.(Pine Knolls EMPOWERment Affordable Community Housing):

EMPOWERment Inc. owns three lots located at Johnson Street, Chapel Hill. These lots are indicated on the accompanying site plans. The lots are currently vacant. One lot previously was the site of a small community center that has been demolished and playground. EMPOWERment, Inc. plans to develop a cluster of buildings that will be used to provide affordable rentals in this neighborhood Affordable Rentals in this neighborhood to families earning 30% Area Medium Income (AMI).

The rectangular shaped property is approximately 30,000 square feet of net land area. There is one existing concrete loop driveway off Johnson Street. The existing drive will be partially removed, and a new vehicular access to the site will be through the west paved driveway connection to Johnson Street. The developer plans to construct a parking lot and a refuse and recycling enclosure at the edge of the proposed parking lot. Pedestrian circulation through the site will be by a series of walkways connecting the buildings, the parking and Johnson Street. A public transit covered waiting area will be created at the street.

An area for a stormwater facility has been designated in the southwest corner of the property. Water and sanitary sewer connections will be made to existing services from Orange Water & Sewer Authority facilities located within the Johnson Street right-of-way.

P.E.A.C.H. is located within the Pine Knolls Neighborhood Conservation District and is intended to enhance and engage the district by creating a new, safe and accessible affordable rental housing alternative within the district.

P.E.A.C.H. will create a change in use from vacant, little used, property to affordable rental housing. This change in use will trigger a number of requirements in the LUMO, including a required R-SS-CUZ rezoning and the need for stormwater treatment, among others.

Landscape buffers in compliance with the LUMO and Town Design Manual will border the project site.

EMPOWERment, Inc., is requesting R-SS-CUZ zoning so that it can provide 10 rental units with a total of 7,700 square feet of floor area. This exceeds the number of living units and the floor area ratio under the existing dimensional criteria for the current R-3 zoning on this site; hence the need for rezoning to the R-SS-CUZ designation.

Statement of Compliance with the Comprehensive Plan

Site and Building Design:

P.E.A.C.H. will incorporate sustainable construction attributes that will provide the owner and the tenants less expensive operating costs and less environmental impact from construction and operation. Among the sustainable construction features are high efficiency thermal detailing for walls; product selection for longevity; low maintenance windows, doors, roofing materials; use of products produced and sourced as close to this project location as possible; low flow plumbing fixtures; high SEER HVAC systems; LED lighting throughout. This project will meet or exceed the North Carolina Model Energy Code.

P.E.A.C.H. will incorporate Universal Design with the intent of developing a better quality of life for the many people who will be living in these residences. The Universal Design features will be incorporated in addition to the NC State Building Code and ADA requirements for accessible design. The 8 principles of Universal Design will be considered and evaluated during the design process. An iterative process between the design team and the non-profit project developer will be followed as the design develops with the 8 principles as a guide for decision making.

P.E.A.C.H. has been designed to be functional, easy to construct and easy to maintain. An example is the rain garden used for storm water control. This method is now a best practice because it includes natural filtering of storm water, decreasing dependence on sand filters that need cleaning and maintenance. In addition, the rain garden will be a complimentary component of the overall landscape design.

P.E.A.C.H. will be low impact project by including strategies that minimize building footprint (using 2 stories), minimize new impervious surface through double loading the required parking lot and incorporating a best practice methodology for treating storm water (see above). The landscaping will be natural, non-invasive, plant types that will acclimate better and faster when planted and will need less maintenance to keep them healthy and alive. Recreation features include a children's playground, a community gathering gazebo, an edible food garden, a natural walking trail through an existing wooded area, easy access to a nearby basketball court and a covered shelter for public transit.

Community Design

By including the variety of studio, 1 bedroom, 2 bedroom and 3 bedroom living units, this project will contribute to the mix of housing in this community. This contribution will be enhanced due to the inclusion of Universal Design and code compliant fully accessible units being planned. Residents may not have to leave their community when they age or need a more supportive living environment if they can relocate to these living units. This is an important element for maintaining a sense of community

over time. This project is compatible with and will enhance the existing community within which it is situated. The design of the building includes horizontal siding, gable end pitched roof structures, walkways and other features that will help tie it to neighboring buildings. The quality and long-lasting nature of the construction will ensure that the building and site remain in excellent condition for many years, providing stability and dependability with the surrounding community. Providing a new residential building with useable outdoor areas will increase the security of the surrounding community and will also provide an example for future revitalization efforts. Because this project will be owned and managed by EmPOWERment, it will help assure the availability of affordable rental housing in this community.

- The P.E.A.C.H. Apartments Project is accessible to schools, healthcare, and grocery shopping. All are less than three miles away from Chapel Hill or Carrboro.
- Public transportation is accessible with the closest bus route being less than one half of a mile away.
- The P.E.A.C.H. Apartments Project is in the Pine Knolls community; an area of Orange County traditionally underserved by affordable housing development. The project's intent is to preserve and bring more affordable housing to the Pine Knolls neighborhood.

Community Sponsorship and Support

Since EMPOWERment first began formulating the P.E.A.C.H. Apartments Project, we have sought out community organizations and individuals at each step of the process, because we are committed to maintaining the legacy of the neighborhood. The Board of Directors for the Pine Knolls Community Center joined EMPOWERment to plan a project for the aging building that would be of value to the community. Because of the lack of affordable rental housing in Chapel Hill, all agreed that the building and the adjacent land could be used to bring new, state of the art, affordable rental units to the Pine Knolls neighborhood. The project would also include a playground and a community garden that would serve as a gathering space for neighbors. We have continued to work with Board Members Dr. Ted Parrish, his family, Damita Hicks and Vence Harris that understand and appreciate the history of the community and the people that need to be served.

In December of 2019 EMPOWERment held a holiday event for the community. At that time, we conducted a survey of the community to assess their support for building P.E.A.C.H. Apartments. EMPOWERment outlined how the project will be dedicated to helping members of the community that need affordable housing as well as a project that will maintain the history of the Pine Knolls neighborhood. The results were overwhelmingly positive for adding more affordable rentals, as well as allow low-income families to live in the town where they work. Providing additional low-income rentals for the Chapel Hill workforce are two of the components of the Orange County 2020-2025 Consolidated Plan.

We are pleased to include planners and architects that have designed units in Chapel Hill. They have an appreciation for the neighborhood and the people and are committed to helping construct a building that will help us maintain the integrity of the Pine Knolls community. Many of the existing homes surrounding the property are older. We are extremely excited to bring this multi-unit, affordable rental housing inventory to the area.

Affordability, Marketing, and Supportive Services

The P.E.A.C.H. Apartments project is in a Conservation District. It is designated to remain affordable permanently, 99 years. We will be ensuring housing affordability by capturing the cash flow from the project and subsidizing units further so that we can serve low-income families. The funds contributed by our funding partners will be fully leveraged to help EMPOWERment recapture subsidies and maintain long-term affordability. The following documents will ensure long-term affordability of this rental housing.

- Deed Restrictions
- Performance Agreements
- Development Agreements
- Project is in a Conservation District

The process that EMPOWERment uses to ensure an adequate pool of income – eligible renters is marketing through our website, NCHousingSearch.com, recommendations from other partners such as Community Empowerment fund, Department of Social Services, local churches and EMPOWERment’s In-house Waitlist of eligible individuals.

Alignment with Goals and Adopted Affordable Housing Policy

The 2020-2025 Consolidated Plan for Orange County is the guiding document for Affordable Housing that includes Chapel Hill, Carrboro, and Hillsborough. Because EMPOWERment’s P.E.A.C.H. Apartments project is new rental construction it can encompass many of the defining goals of the plan, which include:

- New rental construction that is ADA compliant.
- The project is located near a bus route and is easily accessible to retail, schools, healthcare, and local employers.
- Subsidies have been included in the project to allow very low-income families (at or below the 30% AMI) to qualify for designated units. This allows for individuals that work in Chapel Hill to have an opportunity to live near their job.
- EmPOWERment welcomes tenants that are voucher holders.
- EmPOWERment gives priority to applicants that are homeless, veterans, and disabled.
- EmPOWERment has been providing affordable housing in Chapel Hill and Orange County since 1996, and we have been and continue to be committed to providing affordable, safe and compliant rental units to the underserved populations of Chapel Hill and Orange County.



ARCHITECT: JGA Architects
308 West Rosemary Street
Chapel Hill, NC

September 4, 2021

ENGINEER: Phil Post
Providence Rd.
Chapel Hill, NC

RESPONSE TO
CONCEPT PLAN COMMENTS C.D.C.- April 14, 2021
P.E.A.C.H. PROJECT
APPLICATION FOR
R-SS-CUZ

COMMENTS

Building Design

- 1) **Building should have more of a front toward Johnson Street**
- 2) **Perhaps locate front doors to ground units at Johnson St.**
- 3) **Consider porches and other house front elements facing Johnson St.**

Site Design

- 1) **Sidewalks on Johnson Street.**
- 2) **Decrease driveway curb-cut width**
- 3) **Parking at rear?**

Landscape design

- 1) **Screen parking area, but not too tall.**

RESPONSE

Building Design

- 1) **We have re-oriented the building so that it faces Johnson Street.**
- 2) **With this re-orientation we have included doors and front porches which face Johnson St.**
- 3) **We have included porches and roof and building forms that face Johnson Street that traditionally indicate the front of a building.**

Site Design

- 1) **We will request funding for sidewalks from Town of Chapel Hill Sidewalk Fund for sidewalks on Johnson Street.**
- 2) **The driveway curb cut has been decreased, but it is now less than standard Chapel Hill engineering recommendations.**
- 3) **We have kept the parking closer to Johnson Street for several reasons. Parking in this location minimizes driveway length and impervious surface area. It is safer to keep parking in view of the street. We want to develop amenity areas which include a playground and a place for adults to gather while watching the playground. It is safer for the children to keep the playground at a distance from the street.**

Landscape Design

- 1) **We have included parking lot screening that will mature into a short screen.**



ARCHITECT: JGA Architects
308 West Rosemary Street
Chapel Hill, NC

February 24, 2022

ENGINEER: Phil Post
Providence Rd.
Chapel Hill, NC

P.E.A.C.H. PROJECT

SUSTAINABILITY AND ENERGY MANAGEMENT

To: Planning Staff
Town of Chapel Hill
Via: email to planning@townofchapelhill.org

INTRODUCTION

The Town of Chapel Hill has incorporated this as their sustainability goal:

A sustainable community is “future friendly” – it’s a place that works to enhance today’s opportunities for tomorrow’s generation. Being sustainable is about making decisions and taking action, both big and small, that will leave our community better and more resilient than we found it. A sustainable community also finds a healthy and lasting balance between social, economic and environmental interests. It’s a place that values its history, monitors its progress, and innovates to solve problems. The pursuit of a sustainable community is the work of everyone who lives, works and plays within it. Our future begins today.

Our future DOES begin today and PEACH is pleased to be able to help find the balance between social, economic and environmental interests. PEACH will be providing rental housing opportunities to our community members who make 30% or less of the AMI (Average median Income for this SMA). This means that smart and considered decisions need to be made at all points of the design and construction process. PEACH is committed to balancing social and environmental considerations in the development of this project.

Energy Management Plan

This project does not require an Energy Management Plan and achieving the creation of rental units that reach a market at 30% AMI assures meeting sustainability goals of Chapel Hill. We are conscious of- and interested in- energy management as another important component of sustainability and we propose this EMP to further promote a sustainable future for our town.



ARCHITECT: JGA Architects
308 West Rosemary Street
Chapel Hill, NC

February 24, 2022

ENGINEER: Phil Post
Providence Rd.
Chapel Hill, NC

PEACH EMP Goals

- A. Support the Town goal of reduction of carbon emissions.
- B. Utilize sustainable energy in the construction and operation of PEACH apartments.
- C. Utilize sustainable strategies in the construction and operation of PEACH apartment.

PEACH EMP Objectives

- A. This Energy Management Plan is intended to result in a minimum energy efficiency that meets or exceeds 20% over the current ASHRAE minimums.
- B. This Energy Management Plan will give consideration to using alternate technologies that represent sustainable energy technology.
- C. This Energy Management Plan will include elements that help ensure a high level of indoor air quality, adequate access to natural lighting and other indoor environmental quality attributes.
- D. A green building certification standard is not being used for this building.

PEACH EMP General Elements

The component parts of this energy plan will be specific and selected for this building and this type of use. All parts of the plan will give consideration to the following general elements. Please see the PEACH EMP specifics below for elements and strategies chosen. This is a list of design considerations we will evaluate to meet the 20% requirement; the final systems selection and calculations will be provided on the building permit drawings'.

1. High performance motors; Day lighting; Enhanced insulation; weatherstripping, and other building shell features; Indoor Environmental Quality; Air filtering; Daylighting strategies; Light balanced indoor lighting; Use of Low Emitting materials; The design team has included enhanced insulation, day lighting where practicable and weather stripping for the building envelope. We are using high efficiency mechanical equipment which is fuel efficient (see the SEER rating for HVAC and the water heating methodology described below). Low emitting materials are specified for finish and surfacing materials.



ARCHITECT: JGA Architects
308 West Rosemary Street
Chapel Hill, NC

February 24, 2022

ENGINEER: Phil Post
Providence Rd.
Chapel Hill, NC

PEACH EMP Specifics

Empowerment will provide engineering calculations, product specifications and narrative to support the specifics listed in this plan. The engineering calculations, product specifications and narrative will be signed by an engineer licensed to practice in North Carolina.

A. The EMP plan will include the following features:

- 1) Renewable Energy: The project will explore installation of a solar thermal or solar photovoltaic by the project. This will be contingent upon 100% donor support for this project feature. Signed and sealed engineering drawings and specification for the installation will be submitted with our building permit application if either solar option is possible.
- 2) Building overall energy efficiency is to be 20% more than ASHRAE 90.1-2010, the basis for NC Energy Code Performance. Calculations to be provided with building permit application by the Mechanical Engineer.
- 3) Empowerment will provide calculations for Service Water Heater performance and Compliance to Code with performance better than required Energy Factor. Must be over 20 gallon and have recovery system. Calculations provided with building permit application. For water heating we may be using point-of-use water heating devices. We are NOT using water tanks which must be kept hot. The use of point-of-use heating devices is significantly more energy efficient than tanked water heaters.
- 4) Provide and construct Building envelope with increased R values for thermal components that exceed NC Building Code by 20% for this particular type of building. Products and R values will be provided with building permit application. To achieve this we will be employing a water shield type of wall that includes an outboard airspace that adds insulation value.
- 5) Provide HVAC equipment with an SEER of at a minimum of 12 and a 100% fresh air economizer cycle. SEER of 11 is typical Code requirement. Product data to be provided with building permit application. This entire residential facility is provided with operable sash so that fresh air economizers are not being used. We will use mechanical equipment with a SEER of 12 or greater,
- 6) Provide energy summary for end use of each major electrical item such as lighting, Space heating, Space cooling, pumps, heat rejection exhaust and ventilation fans, Service Water Heater, Calculations provided with building permit application.
- 7) Electronic programmable thermostats will be used exclusively throughout.
- 8) All exterior lighting will have photo cell sensors for operation.
- 9) Exterior lighting will have minimum Lumens to meet Building Code requirements for area covered.



ARCHITECT: JGA Architects
308 West Rosemary Street
Chapel Hill, NC

February 24, 2022

ENGINEER: Phil Post
Providence Rd.
Chapel Hill, NC

- 10) Daylighting will be maximized within this project. All rooms with the exception of bathrooms and closets will have windows for light and view. Many windows will be double windows (see elevations).
- 11) All equipment used in this project will be Chlorofluorocarbon free.
- 12) Education will be provided to occupants and managers of building operating systems and of building sustainable attributes.
- 13) Prior to occupancy occupants will have orientation period scheduled to learn about their new building. These orientations will include sustainable building information including materials attributes and operational elements.
- 14) A recycling program will be implemented during building construction to provide for construction waste to be recycled. The project is constructed with public monies and has not yet been bid. We will negotiate this with the successful bidder.
- 15) PEACH will utilize materials with recycled content when possible including structural steel and miscellaneous. Steel will be approximately 90% recycled scrap. Brick, when used, will have recycled content.
- 16) Paints, adhesives and finish materials will be VOC free-low emitting materials. All paints, adhesives and finish materials will be specified to be VOC free, low emitting materials.
- 17) Empowerment will provide for recycling, onsite storage containers..
- 18) Kitchen appliances, when available, will be Energy Star compliant.
- 19) The fixtures specified for this project will require 1.2 gals/flush. This is a savings of .4 gals/flush which is 25% less than the code maximum

For the site development the PEACH EMP will include the following:

- 20) Plant materials for landscaping shall be indigenous plants suitable for local climates and will be xerophytic or requiring minimal water/irrigation rates. We are using plants that are native or adapted to the local climate / soil conditions and that are drought tolerant when established, known to be deer resistant and low maintenance. We are working with the NC Botanical Garden for plant selection in our stormwater management facility.



ARCHITECT: JGA Architects
308 West Rosemary Street
Chapel Hill, NC

February 24, 2022

ENGINEER: Phil Post
Providence Rd.
Chapel Hill, NC

P.E.A.C.H. PROJECT

TENANT ENGAGEMENT TRASH AND RECYCLING

To: Planning Staff
Town of Chapel Hill
Via: email to planning@townofchapelhill.org

INTRODUCTION

EmPOWERment is committed to engaging tenants in the ongoing operation of the PEACH project. We strongly believe that an engaged tenant population will result in an enhanced sense of community. To support this objective we have designed several parts of the ongoing operations with which our tenants will be involved.

- 1) Under guidance from the NC Botanical Garden team, we intend to use the rainwater garden to educate our community about how storm water is treated and controlled. Along with this education will be tutored instruction about how to maintain a rainwater garden. We will be exploring how tenants, under guidance from EmPOWERment staff and the Bot. Garden team, can maintain the plantings in the raingarden and elsewhere on this site.
- 2) Tenants will be asked to take responsibility for rolling trash and recycling carts to the street for pick-up. This will be done with the frequency that trash and recycling pick-up is provided for this site.
- 3) Tenants will be asked to take responsibility for keeping the entire site clean and trash-free. His will include areas around the rolling carts, the transit shelter, the parking area, the playground and the outdoor kiosk shelter.
- 4) The tenants will be using a garden area to grow vegetables and flowering plants. The management of this garden area will be by and for the tenants of PEACH.

Please note that EmPOWERment and EmPOWERment staff will be taking ultimate responsibility for making certain that the above tasks are carried out.

REQUIRED CONDITIONS

1. NCFPC SECTION 510. EMERGENCY RESPONDER RADIO COVERAGE IN NEW BUILDINGS. ALL NEW BUILDINGS SHALL HAVE APPROVED RADIO COVERAGE FOR EMERGENCY RESPONDERS WITHIN THE BUILDING BASED UPON THE EXISTING COVERAGE LEVELS OF THE PUBLIC SAFETY COMMUNICATION SYSTEMS OF THE JURISDICTION AT THE EXTERIOR OF THE BUILDING. THIS SECTION SHALL NOT REQUIRE IMPROVEMENT OF THE EXISTING PUBLIC SAFETY COMMUNICATION SYSTEMS.
2. PRIVATE FIRE SERVICE MAINS [FIRE SPRINKLER LATERAL(S)]: PRIVATE FIRE SERVICE MAINS AND APPURTENANCES SHALL BE INSTALLED IN ACCORDANCE WITH NFPA 24, 2018 NCFPC SECTION 507.
3. CONSTRUCTION/DEMOLITION: ALL CONSTRUCTION AND DEMOLITION CONDUCTED SHALL BE IN COMPLIANCE OF THE CURRENT EDITION OF THE NC FIRE CODE. 2018 NCFPC CHAPTER 33.
4. FIRE WATCH: DURING CONSTRUCTION AND DEMOLITION WHERE HOT WORK, MATERIALS SUBJECT TO SPONTANEOUS COMBUSTION, OR OTHER HAZARDOUS CONSTRUCTION OR DEMOLITION IS OCCURRING, THE OWNER OR THEIR DESIGNEE SHALL BE RESPONSIBLE FOR MAINTAINING A FIRE WATCH. THE FIRE WATCH SHALL CONSIST OF AT LEAST ONE PERSON WITH A MEANS OF COMMUNICATING AN ALARM TO 911, SHALL HAVE A WRITTEN ADDRESS POSTED IN A CONSPICUOUS LOCATION, AND SHALL MAINTAIN CONSTANT PATROLS. 2018 NCFPC SECTION 3304.5.
5. FIRE PROTECTION AND UTILITY PLAN: SHALL INCLUDE THE FIRE FLOW REPORT: FOR A HYDRANT WITHIN 500' OF EACH BUILDING, PROVIDE THE CALCULATED GALLONS PER MINUTE OF WITH A RESIDUAL PRESSURE OF 20 POUNDS PER SQUARE INCH. THE CALCULATIONS SHOULD BE SEALED BY A PROFESSIONAL ENGINEER LICENSED IN THE STATE OF NC AND ACCOMPANIED BY A WATER SUPPLY FLOW TEST CONDUCTED WITHIN ONE YEAR OF THE SUBMITTAL. REFERENCE TOWN DESIGN MANUAL FOR REQUIRED GALLONS PER MINUTE.
6. WATER SUPPLY FOR FIRE PROTECTION: WHEN REQUIRED, AN APPROVED WATER SUPPLY FOR FIRE PROTECTION, EITHER TEMPORARY OR PERMANENT, SHALL BE MADE AVAILABLE AS SOON AS COMBUSTIBLE MATERIAL ARRIVES ON THE SITE. 2018 NCFPC 3312.
7. ADDRESS IDENTIFICATION: 505.1 ADDRESS IDENTIFICATION. NEW AND EXISTING BUILDINGS SHALL BE PROVIDED WITH APPROVED ADDRESS IDENTIFICATION. THE ADDRESS IDENTIFICATION SHALL BE LEGIBLE AND PLACED IN A POSITION THAT IS VISIBLE FROM THE STREET OR ROAD FRONT THE PROPERTY. ADDRESS IDENTIFICATION CHARACTERS SHALL CONTRAST WITH THEIR BACKGROUND. ADDRESS NUMBERS SHALL BE ARABIC NUMBERS OR ALPHABETICAL LETTERS. NUMBERS SHALL NOT BE SPELLED OUT. EACH CHARACTER SHALL BE NOT LESS THAN 6 INCHES (153 MM) HIGH WITH A MINIMUM STROKE WIDTH OF 3/4 INCH (20 MM). WHERE REQUIRED BY THE FIRE CODE OFFICIAL, ADDRESS IDENTIFICATION SHALL BE PROVIDED IN ADDITIONAL APPROVED LOCATIONS TO FACILITATE EMERGENCY RESPONSE. WHERE ACCESS IS BY MEANS OF A PRIVATE ROAD AND THE BUILDING CANNOT BE VIEWED FROM THE PUBLIC WAY, A MONUMENT, POLE, OR OTHER SIGN OR MEANS SHALL BE USED TO IDENTIFY THE STRUCTURE. ADDRESS IDENTIFICATION SHALL BE MAINTAINED. 2018 NCFPC 505.1.
8. FIRE LANES: WHERE REQUIRED BY THE FIRE CODE OFFICIAL, APPROVED SIGNS OR OTHER APPROVED NOTICES OR MARKINGS THAT INCLUDE THE WORDS NO PARKING-FIRE LANE SHALL BE PROVIDED FOR FIRE APPARATUS ACCESS ROADS TO IDENTIFY SUCH ROADS OR PROHIBIT THE OBSTRUCTION THEREOF. THE MEANS BY WHICH FIRE LANES ARE DESIGNATED SHALL BE MAINTAINED IN A CLEAN AND LEGIBLE CONDITION AT ALL TIMES AND BE REPLACED OR REPAIRED WHEN NECESSARY TO PROVIDE ADEQUATE VISIBILITY. 2018 NCFPC SECTION 503.3 AND APPENDIX D D 103.A, D 103.A.1, D 103.B.2.
9. GATES AND BARRICADES: 03.5 REQUIRED GATES OR BARRICADES. THE FIRE CODE OFFICIAL IS AUTHORIZED TO REQUIRE THE INSTALLATION AND MAINTENANCE OF GATES OR OTHER APPROVED BARRICADES ACROSS FIRE APPARATUS ACCESS ROADS, TRAILS, OR OTHER ACCESSWAYS; NOT INCLUDING PUBLIC STREETS, ALLEYS, OR HIGHWAYS. ELECTRIC GATE OPERATORS, WHERE PROVIDED, SHALL BE LISTED IN ACCORDANCE WITH UL 325. GATES INTENDED FOR AUTOMATIC OPERATION SHALL BE DESIGNED, CONSTRUCTED, AND INSTALLED TO COMPLY WITH THE REQUIREMENTS OF ASTM F2200. 2018 NCFPC SECTION 503 AND APPENDIX D103.
10. FIRE DEPARTMENT ACCESS/CONSTRUCTION: DURING CONSTRUCTION, VEHICLE ACCESS FOR FIRE FIGHTING SHALL BE PROVIDED. TEMPORARY STREET SIGNS SHALL BE INSTALLED AT EACH STREET INTERSECTION WHEN CONSTRUCTION ALLOWS THE PASSAGE OF VEHICLES. SIGNS SHALL BE OF AN APPROVED SIZE, WEATHER RESISTANT, AND MAINTAINED UNTIL REPLACED BY PERMANENT SIGNS. 2018 NCFPC SECTION 505.2.
11. FIRE DEPARTMENT ACCESS/CONSTRUCTION: FENCING AROUND PROJECTS SHALL INCLUDE ACCESS GATES WITH A 20 FOOT SWING OR SLIDE MOTION. ANY AREAS WHICH WILL BE INACCESSIBLE FOR FIRE FIGHTING OR RESCUE OPERATIONS SHALL BE NOTED. EMERGENCY ACCESS DESIGNATION FOR APPARATUS SHALL BE PROVIDED. 2018 NCFPC SECTION 503, APPENDIX D.

NOTES:

1. ALL NEW UTILITIES SHALL BE LOCATED UNDERGROUND THROUGHOUT THE SITE AS ALLOWED BY LOCAL CODES, UNLESS OTHERWISE SHOWN ON PLANS.
2. ALL PUBLIC UTILITIES AND CONNECTIONS TO PUBLIC UTILITIES SHALL CONFORM TO THE TOWN OF CHAPEL HILL STANDARDS AND SPECIFICATIONS.
3. THE CONTRACTOR IS RESPONSIBLE FOR OBTAINING ANY PERMITS NECESSARY FOR CONSTRUCTION.
4. THE CONTRACTOR SHALL BE RESPONSIBLE FOR COORDINATION OF THE LOCATION AND/OR RELOCATION OF ALL EXISTING UTILITIES WITH THE APPROPRIATE UTILITY, AGENCY OR COMPANY.
5. THE CONTRACTOR SHALL COORDINATE ALL UTILITY CONNECTIONS AND DISTURBANCES WITH EXISTING USERS, THE TOWN OF CHAPEL HILL AND APPROPRIATE UTILITY COMPANIES SO THAT ANY SERVICE INTERRUPTIONS ARE MINIMAL.
6. UTILITY CONNECTIONS FOR BUILDING PLUMBING LINES SHALL BE COORDINATED BY CONTRACTOR. LOCATIONS, BOTH HORIZONTAL AND VERTICAL, SHALL BE VERIFIED PRIOR TO BEGINNING THEIR CONSTRUCTION.
7. SEWER CLEANOUTS IN PAVED AREAS SHALL BE TRAFFIC BEARING.



Know what's below.
Call before you dig.

CONTRACTOR SHALL NOTIFY "NC811" (811) OR (1-800-632-4848) AT LEAST 3 FULL BUSINESS DAYS PRIOR TO BEGINNING CONSTRUCTION OR EXCAVATION TO HAVE EXISTING UTILITIES LOCATED. CONTRACTOR SHALL CONTACT ANY LOCAL UTILITIES THAT PROVIDE THEIR OWN LOCATOR SERVICES INDEPENDENT OF "NC811". REPORT ANY DISCREPANCIES TO THE ENGINEER IMMEDIATELY.

CIVIL ENGINEER

PHILIP POST ENGINEERING, INC.
PHILIP N. POST, PE, PLS
PO BOX 4912
CHAPEL HILL, N.C. 27515
TEL. (919) 818-7862
philip.n.post@gmail.com

ARCHITECT

JOSH GURLITZ
JGA ARCHITECTS
308 W. ROSEMARY ST, SUITE 302
CHAPEL HILL, NC 27516
TEL. (919) 537-5875
josh@joshgurlitz.com

OWNER

DELORES BAILEY
EMPOWERMENT, INC.
109 N. GRAHAM ST, SUITE 200
CHAPEL HILL, NC 27514
TEL. (919) 967-8779
delores.bailey@gmail.com

CONDITIONAL USE ZONING FOR PEACH APARTMENTS

107 & 107 A/B JOHNSON STREET
CHAPEL HILL, NORTH CAROLINA

PIN: 9788-03-2946, 9788-03-0899 & 9788-03-0940

DATE: JULY 21, 2021

REVISION #1: JANUARY 14, 2022

REVISION #2: FEBRUARY 26, 2022

Sheet List Table	
Sheet Number	Sheet Title
C-1	COVER SHEET
C-2	AREA MAP
C-3	EXISTING CONDITIONS - SLOPE ANALYSIS PLAN
C-4	DEMOLITION PLAN
C-5	SITE PLAN
C-6	GRADING & DRAINAGE & UTILITY PLAN
C-7	EROSION CONTROL - CONSTRUCTION MANAGEMENT PLAN
D-1	SITE DETAILS
D-2	SITE DETAILS
D-3	SITE DETAILS
LI-1	LIGHTING PLAN
L-1	LANDSCAPE PLAN

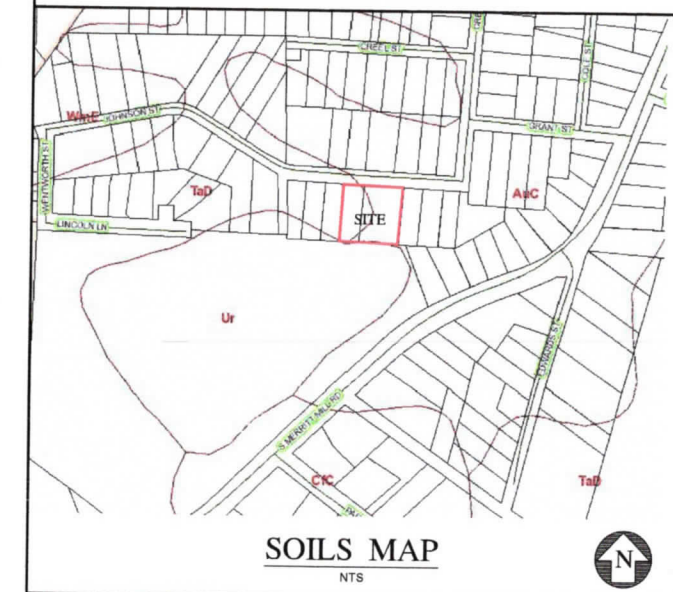
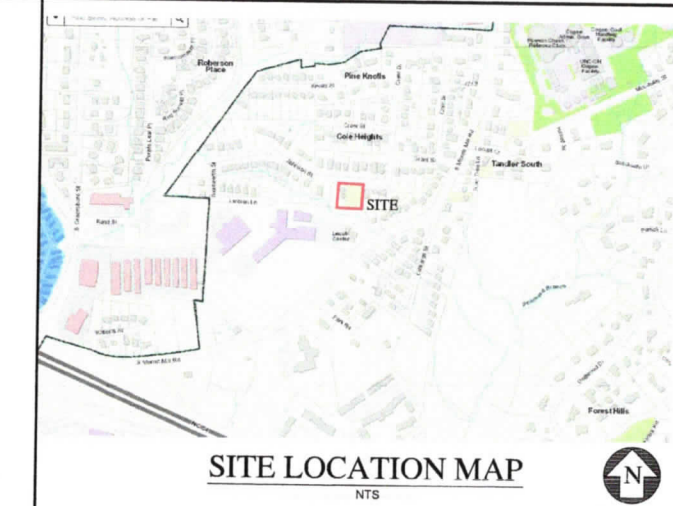

DEVELOPMENT INFORMATION

NET LAND AREA = 29,258 SF (0.67 AC)
GROSS LAND AREA = 32,164 SF (0.74 AC)
EXISTING ZONING = R-3
PROPOSED ZONING = R-SS-CZD
PROPOSED AFFORDABLE DWELLING UNITS: 10 UNITS
(2) EFFICIENCIES, (4) ONE BEDROOM, (3) TWO BEDROOM, (1) THREE BEDROOM
PROPOSED FLOOR AREA = 7,897 SF
LUMO PARKING: 12 TO 15 SPACES
PROPOSED PARKING: 9 REGULAR
2 ACCESSIBLE
2 OVERFLOW
13 TOTAL SPACES
BICYCLE PARKING: 4 SPACES
PROPOSED AMENITIES: PLAYGROUND; GAZEBO, COMMUNITY GARDEN
PROPOSED STORMWATER CONTROL MEASURE: BIORETENTION SCM
PROPOSED DISTURBED AREA = 23,399 SF (0.537 AC)
EXISTING IMPERVIOUS AREA = 5,141 SF (0.118 AC)
PROPOSED IMPERVIOUS AREA =
ROOFS = 5,891 SF (MAIN)
ROOFS = 113 SF (GAZEBO)
ROOFS = 60 SF (SHELTER)
WALKSWALLS = 1,380 SF
DRIVES = 4,064 SF
TOTAL = 11,508 SF (0.26 AC)
NET NEW IMPERVIOUS SURFACE = 6,367 SF (0.146 AC)



NO.	REVISIONS	DATE	BY
7			
6			
5			
4			
3	FORM COMMENTS	2/28/2022	DMC
2	ISSUE ITEMS	1/14/2022	DMC
1			

PROJECT ENGINEER	PHILIP N. POST
CHECKED BY	PHILIP N. POST
DRAWN BY	DC
FIRST ISSUE DATE	07/21/2021

Philip Post Engineering, Inc. is not to be used for any project or site unless specifically identified herein. All other projects or sites are to be returned upon the written consent of Philip Post Engineering, Inc. (07/21/2021)

Philip N. Post, PE, PLS
(919) 818-7862
philip.n.post@gmail.com
PO Box 4912
Chapel Hill, NC 27515
PHILIP POST ENGINEERING
FIRM: C-347

CONDITIONAL USE ZONING
PEACH APARTMENTS
107 & 107 A/B JOHNSON STREET - PIN: 9788-03-2946, 9788-03-0899 & 9788-03-0940
CHAPEL HILL, NORTH CAROLINA
COVER SHEET

PROJECT NO.
PEACH
DRAWING NAME:
PEACH_CS.dwg
SHEET NO.
C-1

PRELIMINARY NOT FOR CONSTRUCTION

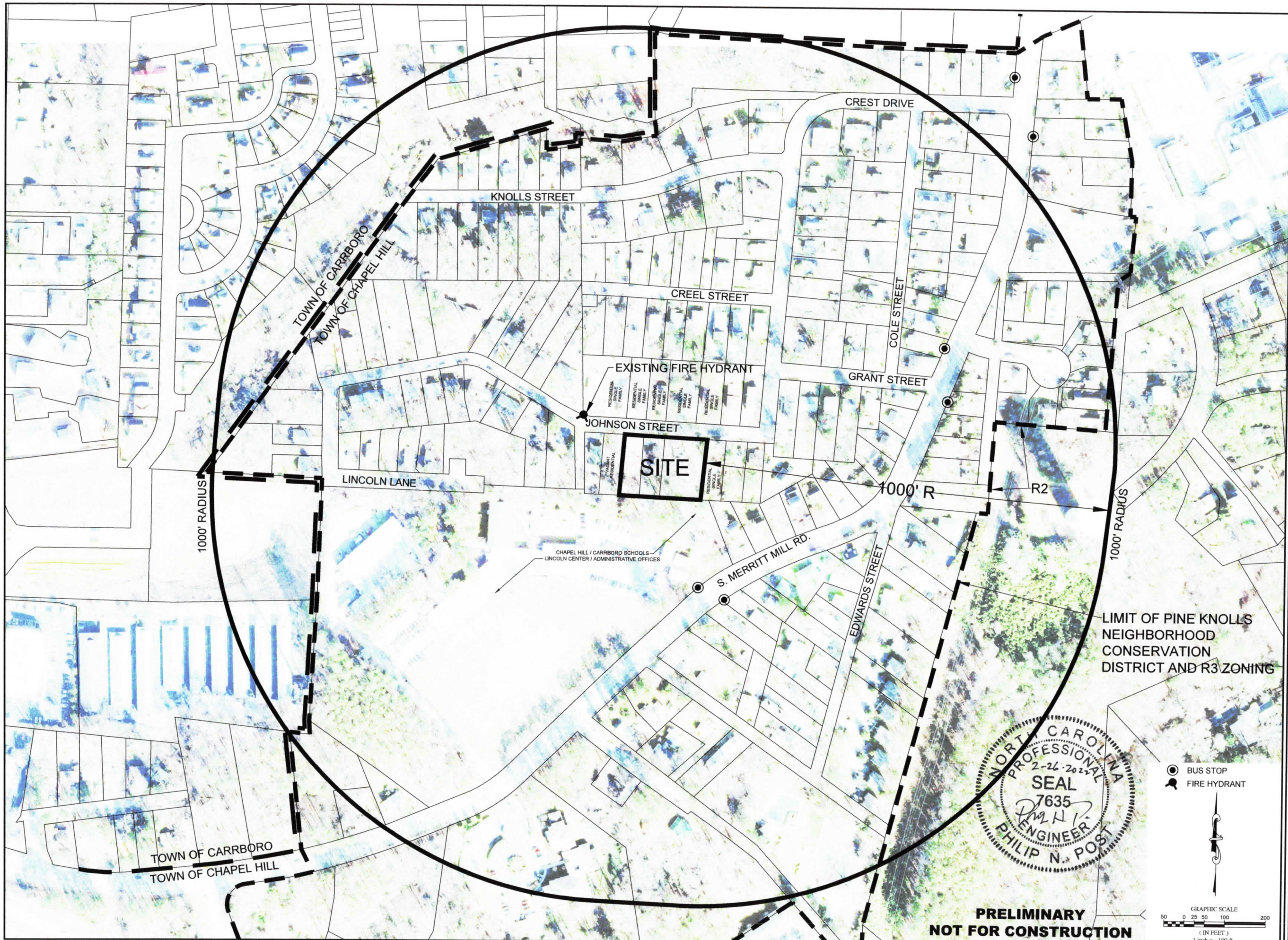

SITE

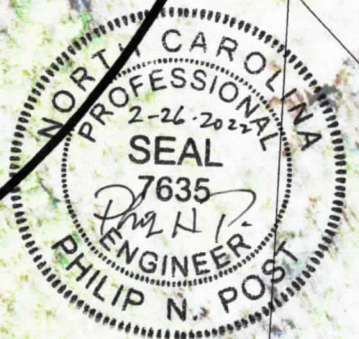

- BUS STOP
- FIRE HYDRANT

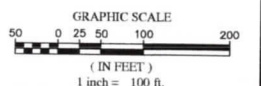

**PRELIMINARY
NOT FOR CONSTRUCTION**

<p>Philip Post Engineering, Inc. and its employees are the authors of this drawing. It is not to be reproduced or copied in whole or in part without the written consent of Philip Post Engineering, Inc. All rights reserved. This drawing is the property of Philip Post Engineering, Inc. and is not to be used for any other project or site without the written consent of Philip Post Engineering, Inc. (CPEP-PROJ01 2021)</p>																											
<p>PROJECT ENGINEER PNP</p>	<p>CHECKED BY PNP</p>	<p>DRAWN BY DC</p>	<p>FIRST ISSUE DATE 07-27-2021</p>																								
<p>PHILIP N. Post, PE, PLS (919) 818-7862 philip.n.post@gmail.com PO Box 4912 Chapel Hill, NC 27515</p>	<p>PHILIP POST ENGINEERING FIRM: C 347</p>	<p>CONDITIONAL USE ZONING PEACH APARTMENTS 107 & 107-AB JOHNSON STREET - PIN 9788-03-2946, 9788-03-0899 & 9788-03-0940 CHAPEL HILL - NORTH CAROLINA</p>	<p>AREA MAP</p>																								
<p>PROJECT NO. PEACH</p>	<p>DRAWING NAME AREA MAP.dwg</p>	<p>SHEET NO. C-2</p>	<p>REVISIONS</p> <table border="1"> <thead> <tr> <th>NO.</th> <th>DATE</th> <th>BY</th> </tr> </thead> <tbody> <tr> <td>7</td> <td></td> <td></td> </tr> <tr> <td>6</td> <td></td> <td></td> </tr> <tr> <td>5</td> <td></td> <td></td> </tr> <tr> <td>4</td> <td></td> <td></td> </tr> <tr> <td>3</td> <td></td> <td></td> </tr> <tr> <td>2</td> <td>2/26/2022</td> <td>DC</td> </tr> <tr> <td>1</td> <td>1/14/2022</td> <td>DC</td> </tr> </tbody> </table>	NO.	DATE	BY	7			6			5			4			3			2	2/26/2022	DC	1	1/14/2022	DC
NO.	DATE	BY																									
7																											
6																											
5																											
4																											
3																											
2	2/26/2022	DC																									
1	1/14/2022	DC																									

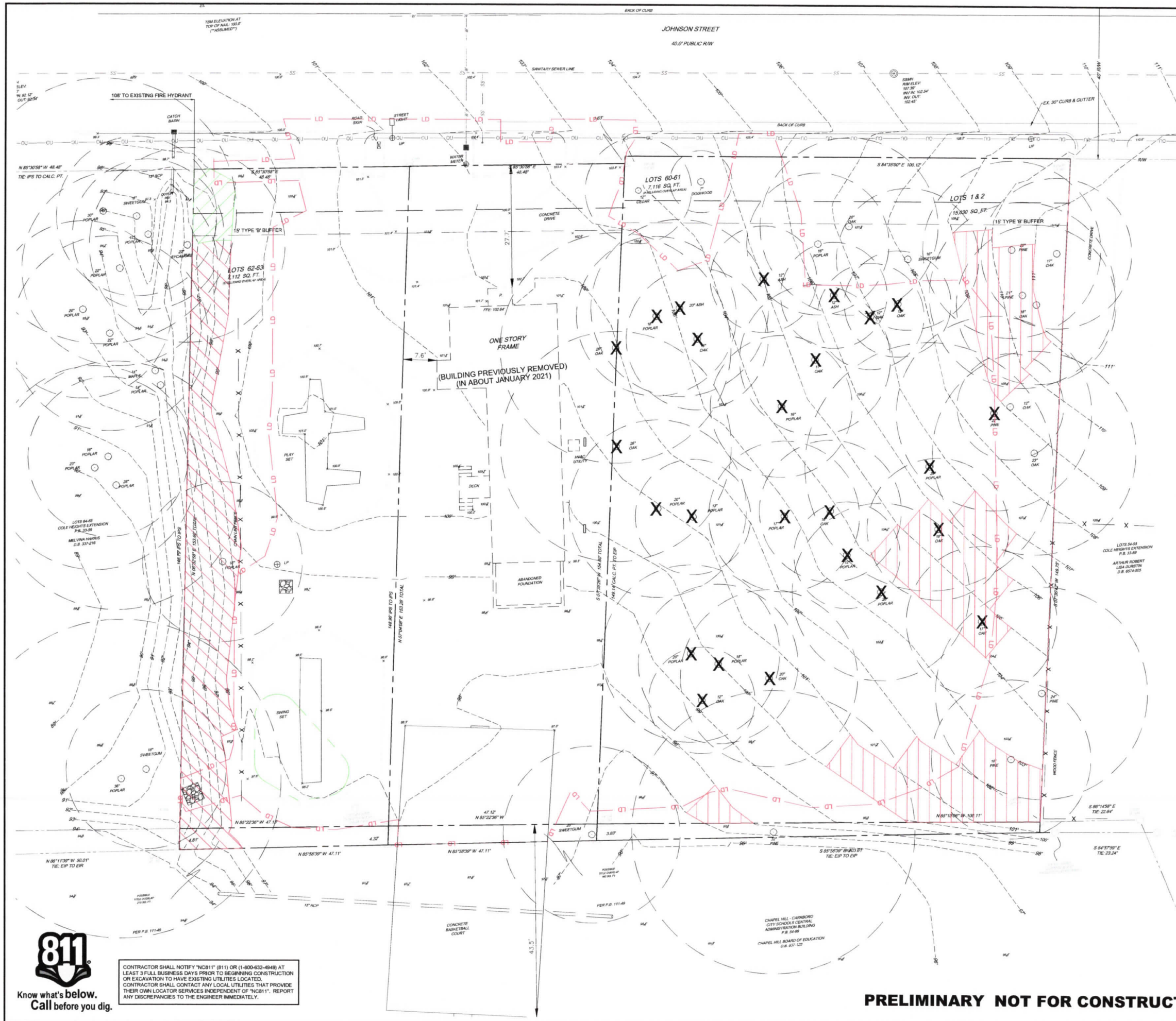

SLOPES LEGEND

	10% TO 15% SLOPES AREA = 1853 SF DISTURBED = 870 SF
	15% TO 25% SLOPES AREA = 138 SF DISTURBED = 0 SF
	OVER 25% SLOPES AREA = 1318 SF DISTURBED = 87 SF

REMAINDER OF SITE IS LESS THAN 10%

NOTE:
ALL INFORMATION ON THIS MAP WAS FIELD SURVEYED, USING ASSUMED ELEVATION AT TBM AS SHOWN HEREON.
To convert to MSL datum, add 330 to all grades.

LEGEND

	TELEPHONE PEDESTAL
	CONTROLLER CABINET
	CURB INLET
	DROP INLET
	LIGHT POLE
	WATER METER
	WATER VALVE
	TRAFFIC SIGNAL BOX
	EXISTING SEWER MANHOLE
	CLEAN OUT
	FIRE HYDRANT
	POWER/LIGHT POLE
	GUY WIRE
	EXISTING MONUMENT FOUND
	IRON ROD OR PIPE
	CONCRETE MONUMENT SET
	CONCRETE MONUMENT
	EXISTING PIPE/CULVERT
	EXISTING WATER LINE
	EXISTING SANITARY SEWER LINE
	EXISTING TELEPHONE
	EXISTING GAS LINE
	EXISTING OVERHEAD UTILITY
	EXISTING UNDERGROUND UTILITY
	EXISTING WOODS LINE
	LIMITS OF DISTURBANCE LINE



CONTRACTOR SHALL NOTIFY 'NC811' (811) OR (1-800-433-6849) AT LEAST 3 FULL BUSINESS DAYS PRIOR TO BEGINNING CONSTRUCTION OR EXCAVATION TO HAVE EXISTING UTILITIES LOCATED. CONTRACTOR SHALL CONTACT ANY LOCAL UTILITIES THAT PROVIDE THEIR OWN LOCATOR SERVICES INDEPENDENT OF 'NC811'. REPORT ANY DISCREPANCIES TO THE ENGINEER IMMEDIATELY.

PRELIMINARY NOT FOR CONSTRUCTION

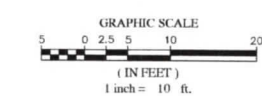

NO.	REVISIONS	DATE	BY
7			
6			
5			
4			
3			
2	TOWN COMMENTS	2/28/2022	DMC
1	ISSUE	1/14/2022	DMC

PROJECT ENGINEER	PHILIP N. POST
CHECKED BY	PHILIP N. POST
DRAWN BY	DC
FIRST ISSUE DATE	07-21-2021

Philip N. Post Engineering, Inc. is not responsible for the use of this drawing for any purpose other than that intended by the engineer. It is to be used only for the project and for the site shown hereon. It is to be returned upon the written request of the client. Philip N. Post Engineering, Inc. is not responsible for the use of this drawing for any purpose other than that intended by the engineer.

Philip N. Post, PE, PLS
 (919) 818-7862
 philip.n.post@gmail.com
 PO Box 4912
 Chapel Hill, NC 27515

PHILIP POST ENGINEERING
 FIRM: C-347

CONDITIONAL USE ZONING
PEACH APARTMENTS
 107 & 107-AB JOHNSON STREET - P/N: 9788-03-2946, 9788-03-2948 & 9788-03-0940
 CHAPEL HILL, NORTH CAROLINA

EXISTING CONDITIONS - SLOPE ANALYSIS PLAN

PROJECT NO.
PEACH
 DRAWING NAME
 PEACH_XC.dwg
 SHEET NO.
C-3

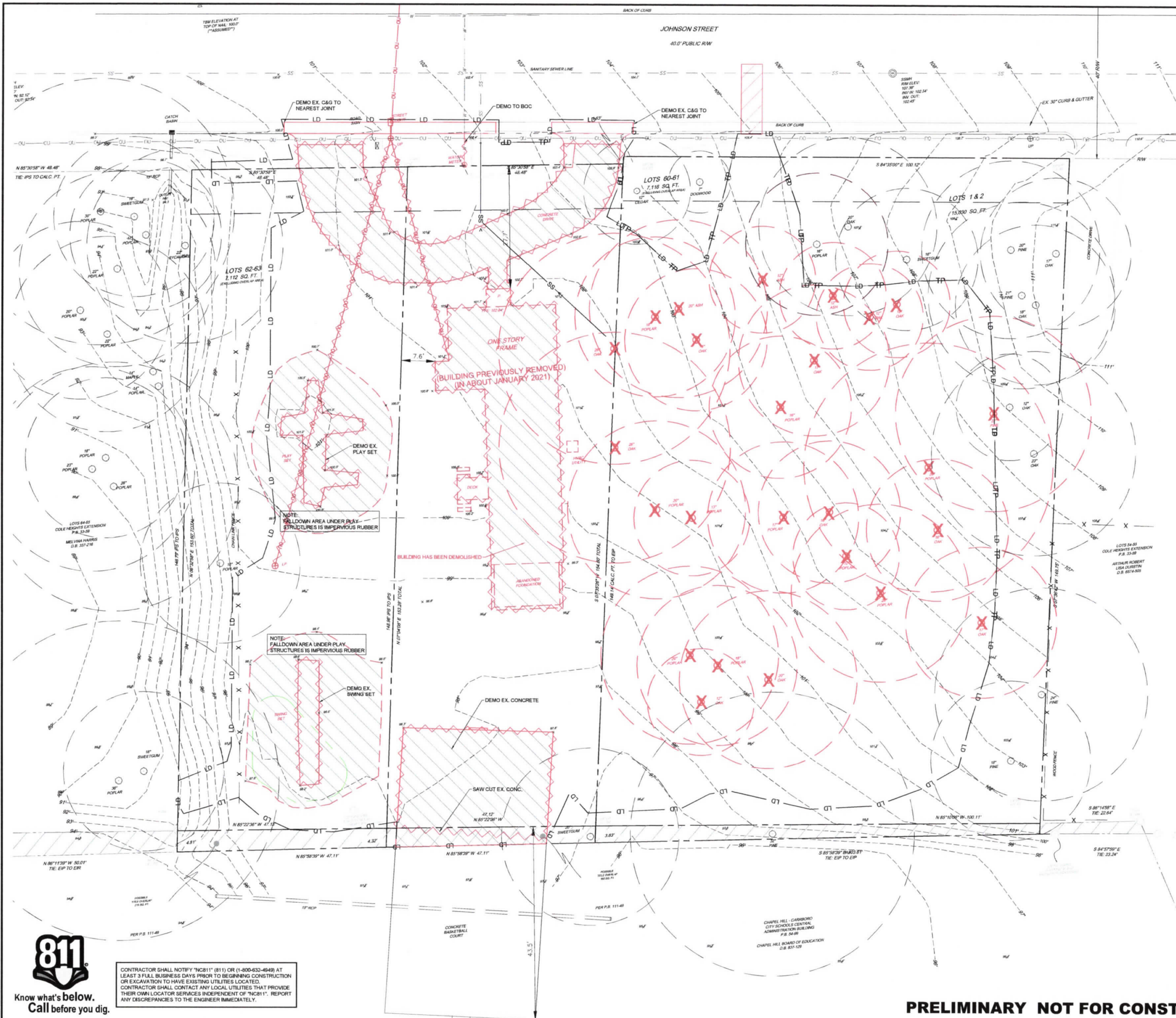

- LEGEND**
- TELEPHONE PEDESTAL
 - CONTROLLER CABINET
 - CURB INLET
 - DROP INLET
 - LIGHT POLE
 - WATER METER
 - WATER VALVE
 - TRAFFIC SIGNAL BOX
 - EXISTING SEWER MANHOLE
 - CLEAN OUT
 - FIRE HYDRANT
 - POWER/LIGHT POLE
 - GUY WIRE
 - EXISTING MONUMENT FOUND
 - IRON ROD OR PIPE
 - CONCRETE MONUMENT SET
 - CONCRETE MONUMENT
 - EXISTING PIPE/CULVERT
 - EXISTING WATER LINE
 - EXISTING SANITARY SEWER LINE
 - EXISTING TELEPHONE
 - EXISTING GAS LINE
 - EXISTING OVERHEAD UTILITY
 - EXISTING UNDERGROUND UTILITY
 - EXISTING WOODS LINE
 - LIMITS OF DISTURBANCE LINE

EXISTING IMPERVIOUS AREAS DEMOLISHED = 5,141 SF

NOTE: FALLDOWN AREA UNDER PLAY STRUCTURES IS IMPERVIOUS RUBBER

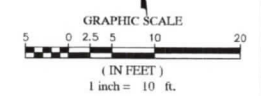

PRELIMINARY NOT FOR CONSTRUCTION



CONTRACTOR SHALL NOTIFY 'NC811' (811) OR (1-800-633-6849) AT LEAST 3 FULL BUSINESS DAYS PRIOR TO BEGINNING CONSTRUCTION OR EXCAVATION TO HAVE EXISTING UTILITIES LOCATED. CONTRACTOR SHALL CONTACT ANY LOCAL UTILITIES THAT PROVIDE THEIR OWN LOCATOR SERVICES INDEPENDENT OF 'NC811'. REPORT ANY DISCREPANCIES TO THE ENGINEER IMMEDIATELY.

NO.	REVISIONS	DATE	BY
7			
6			
5			
4			
3	TOWN COMMENTS	2/26/2023	DWG
2		1/14/2022	DWG
1	MISC. ITEMS		

PROJECT ENGINEER
PHILIP N. POST

CHECKED BY
PHILIP N. POST

DRAWN BY
DC

FIRST ISSUE DATE
07-21-2021

PHILIP N. Post, PE, PLS
(919) 818-7862
philip.n.post@gmail.com
PO Box 4912
Chapel Hill, NC 27515

PHILIP N. POST
ENGINEERING
FIRM: C-347

CONDITIONAL USE ZONING
PEACH APARTMENTS
107 & 107A/B JOHNSON STREET - PH: 9788-03-2946, 9788-03-0940
CHAPEL HILL, NORTH CAROLINA

DEMOLITION PLAN

PROJECT NO.
PEACH

DRAWING NAME:
PEACH_DEM.dwg

SHEET NO.
C-4

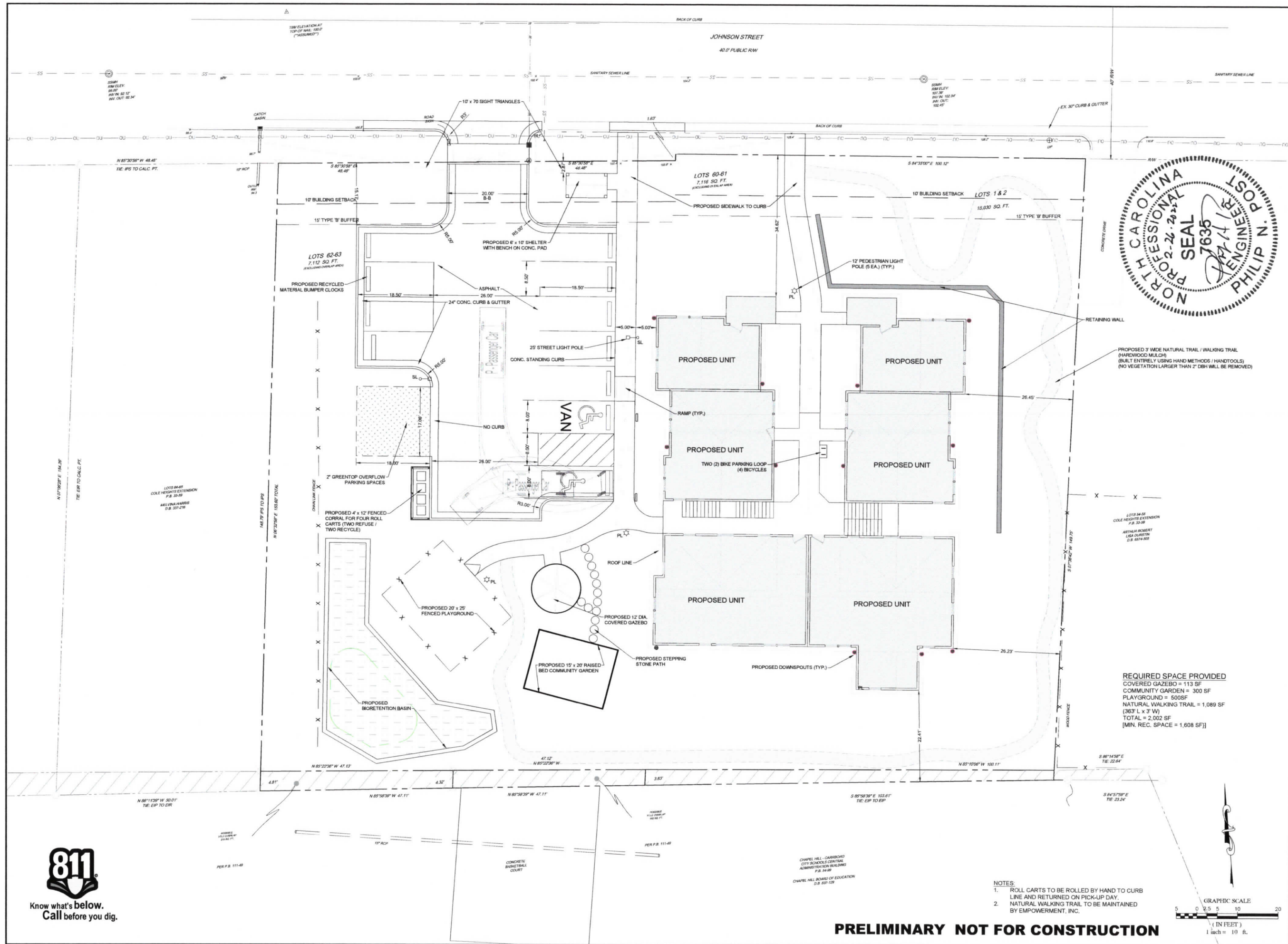

PROPOSED 3' WIDE NATURAL TRAIL / WALKING TRAIL (HARDWOOD MULCH) (BUILT ENTIRELY USING HAND METHODS / HANDTOOLS) (NO VEGETATION LARGER THAN 2" DBH WILL BE REMOVED)

REQUIRED SPACE PROVIDED
 COVERED GAZEBO = 113 SF
 COMMUNITY GARDEN = 300 SF
 PLAYGROUND = 500SF
 NATURAL WALKING TRAIL = 1,089 SF
 (363' L x 3' W)
 TOTAL = 2,002 SF
 [MIN. REC. SPACE = 1,608 SF]

- NOTES:**
- ROLL CARTS TO BE ROLLED BY HAND TO CURB LINE AND RETURNED ON PICK-UP DAY.
 - NATURAL WALKING TRAIL TO BE MAINTAINED BY EMPOWERMENT, INC.

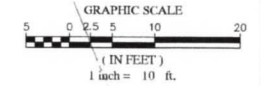

NO.	REVISIONS	BY	DATE
7			
6			
5			
4			
3			
2	TOWN COMMENTS	DMC	2/26/2023
1	MISC. ITEMS	DMC	1/14/2023

PROJECT ENGINEER	PHILIP N. POST
CHECKED BY	PHILIP N. POST
DRAWN BY	DC
FIRST ISSUE DATE	07-21-2021

PHILIP N. Post, PE, PLS
 (919) 818-7862
 philip.n.post@gmail.com
 PO Box 4912
 Chapel Hill, NC 27515

PHILIP N. POST ENGINEERING
 FIRM: C.347

CONDITIONAL USE ZONING
PEACH APARTMENTS
 107 & 107A/B JOHNSON STREET - PIN: 9788-03-2946, 9788-03-0888 & 9788-03-0940
 CHAPEL HILL, NORTH CAROLINA

SITE PLAN

PROJECT NO. PEACH
 DRAWING NAME: SITE PLAN.dwg
 SHEET NO. C-5



PRELIMINARY NOT FOR CONSTRUCTION

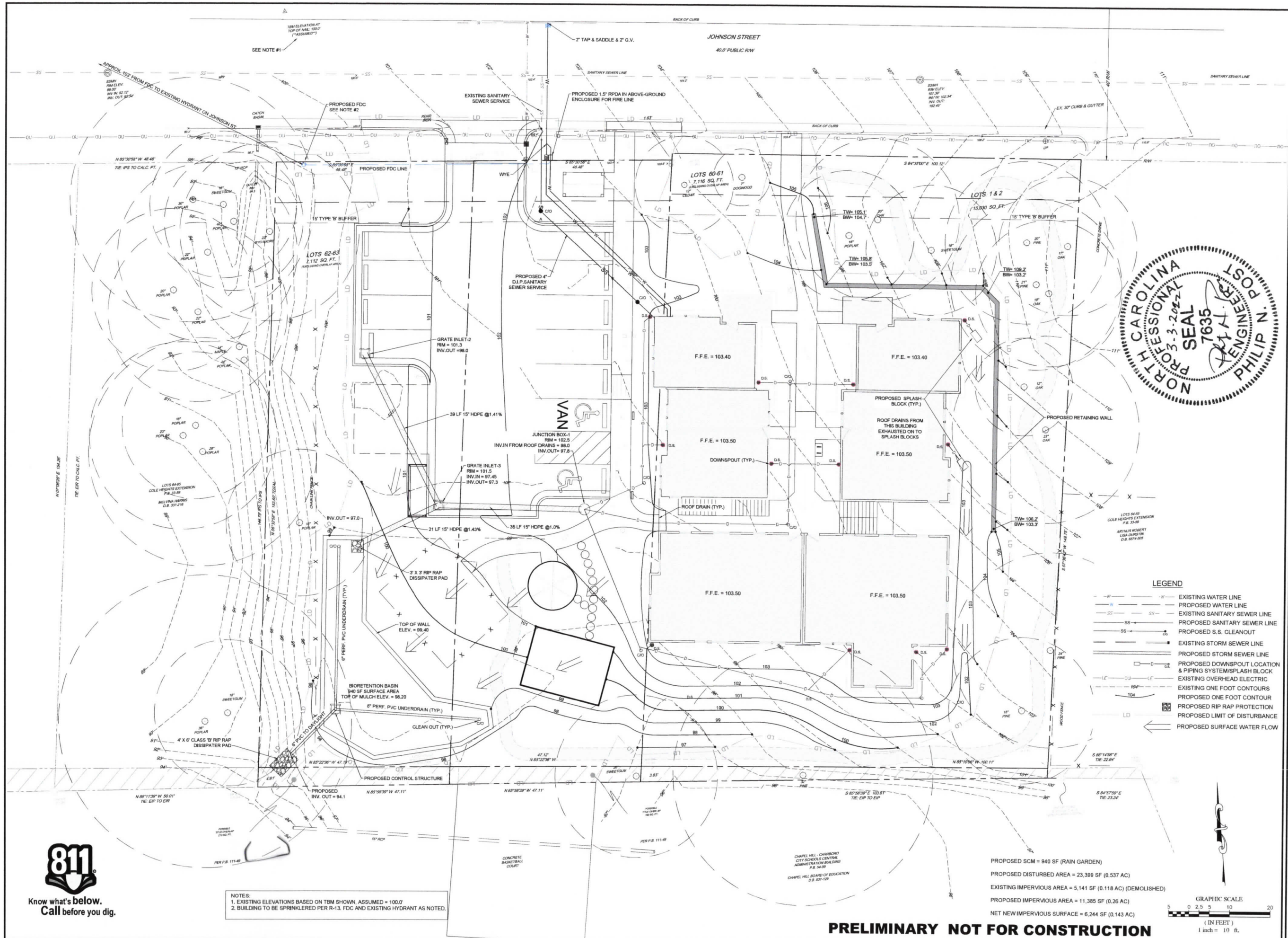

LEGEND

	EXISTING WATER LINE
	PROPOSED WATER LINE
	EXISTING SANITARY SEWER LINE
	PROPOSED SANITARY SEWER LINE
	PROPOSED S.S. CLEANOUT
	EXISTING STORM SEWER LINE
	PROPOSED STORM SEWER LINE
	PROPOSED DOWNSPOUT LOCATION & PIPING SYSTEM/SPLASH BLOCK
	EXISTING OVERHEAD ELECTRIC
	EXISTING ONE FOOT CONTOURS
	PROPOSED ONE FOOT CONTOUR
	PROPOSED RIP RAP PROTECTION
	PROPOSED LIMIT OF DISTURBANCE
	PROPOSED SURFACE WATER FLOW

PROPOSED SCM = 940 SF (RAIN GARDEN)
 PROPOSED DISTURBED AREA = 23,399 SF (0.537 AC)
 EXISTING IMPERVIOUS AREA = 5,141 SF (0.118 AC) (DEMOLISHED)
 PROPOSED IMPERVIOUS AREA = 11,385 SF (0.26 AC)
 NET NEW IMPERVIOUS SURFACE = 6,244 SF (0.143 AC)

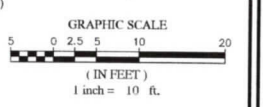

NOTES:
 1. EXISTING ELEVATIONS BASED ON TBM SHOWN, ASSUMED = 100.0'
 2. BUILDING TO BE SPRINKLERED PER R-13, FDC AND EXISTING HYDRANT AS NOTED.



PRELIMINARY NOT FOR CONSTRUCTION

PROJECT ENGINEER PHILIP N. POST		CHECKED BY PHILIP N. POST		DRAWN BY PHILIP N. POST		FIRST ISSUE DATE 02/10/2021																									
PROJECT NAME PEACH APARTMENTS 107 & 107A-B JOHNSON STREET - PH: 9788-03-2946, 9788-03-0689 & 9788-03-0640 CHAPEL HILL, NORTH CAROLINA		PROJECT NUMBER C-6		SHEET NUMBER C-6		REVISIONS <table border="1"> <tr> <th>NO.</th> <th>DATE</th> <th>BY</th> </tr> <tr> <td>1</td> <td>1/14/2022</td> <td>DMC</td> </tr> <tr> <td>2</td> <td>2/28/2022</td> <td>DMC</td> </tr> <tr> <td>3</td> <td>3/22/2022</td> <td>DMC</td> </tr> <tr> <td>4</td> <td></td> <td></td> </tr> <tr> <td>5</td> <td></td> <td></td> </tr> <tr> <td>6</td> <td></td> <td></td> </tr> <tr> <td>7</td> <td></td> <td></td> </tr> </table>		NO.	DATE	BY	1	1/14/2022	DMC	2	2/28/2022	DMC	3	3/22/2022	DMC	4			5			6			7		
NO.	DATE	BY																													
1	1/14/2022	DMC																													
2	2/28/2022	DMC																													
3	3/22/2022	DMC																													
4																															
5																															
6																															
7																															
<p>Philip Post Engineering, Inc. is not responsible for the design or construction of any project unless it is specifically identified herein and the project is within the scope of the professional seal of Philip Post Engineering, Inc. No other project or site shall be returned upon the written request of Philip Post Engineering, Inc. (02/10/2021)</p> <p>Philip N. Post, PE, PLS (919) 818-7862 philip.n.post@gmail.com PO Box 4912 Chapel Hill, NC 27515</p> <p>PHILIP POST ENGINEERING FIRM: C-347</p> <p>CONDITIONAL USE ZONING PEACH APARTMENTS 107 & 107A-B JOHNSON STREET - PH: 9788-03-2946, 9788-03-0689 & 9788-03-0640 CHAPEL HILL, NORTH CAROLINA</p> <p>GRADING & DRAINAGE & UTILITY PLAN</p>																															

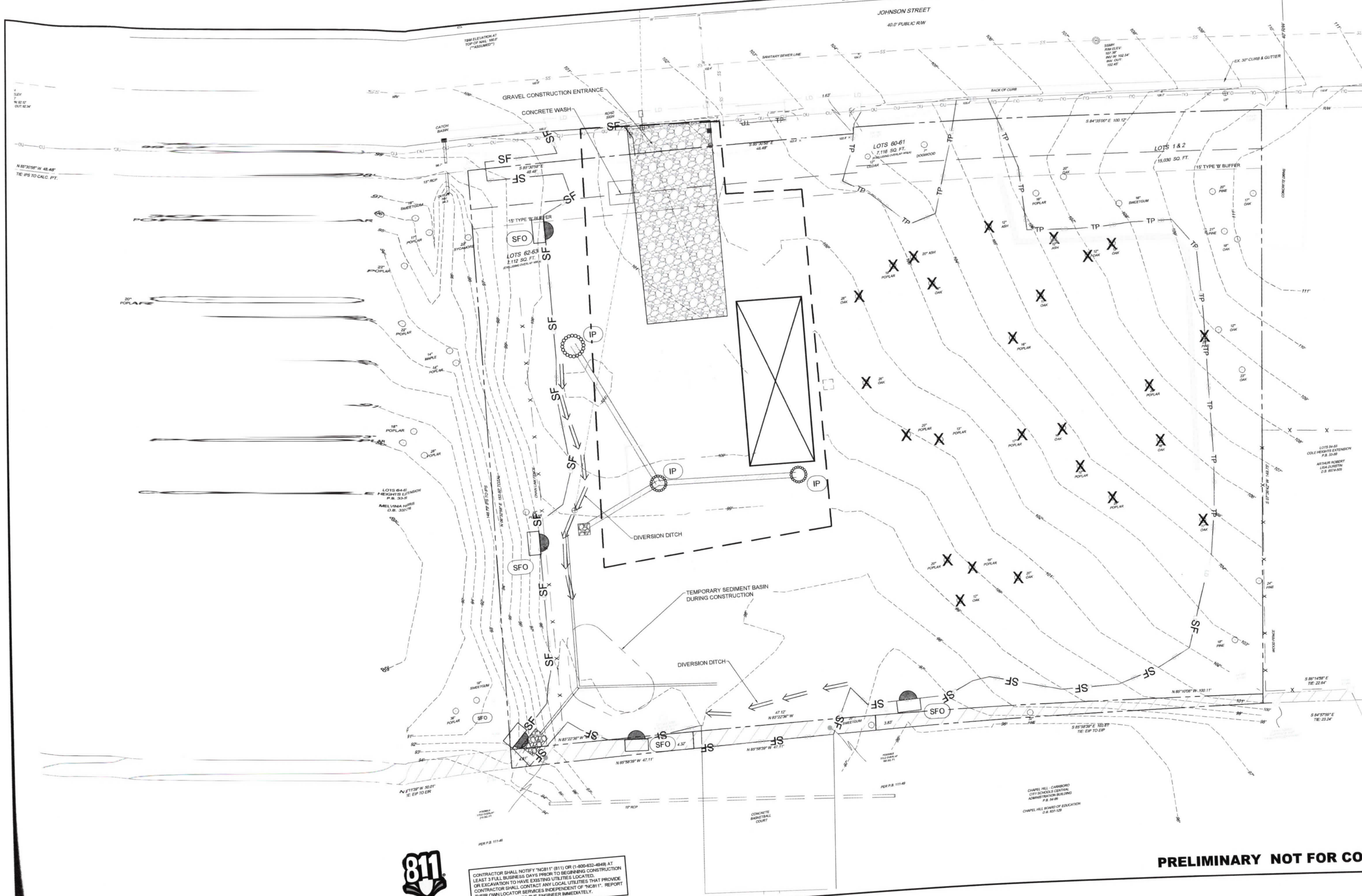

now what's below.
Call before you dig.

CONTRACTOR SHALL NOTIFY "811" (811) OR (1-800-632-4849) AT LEAST 3 FULL BUSINESS DAYS PRIOR TO BEGINNING CONSTRUCTION OR EXCAVATION TO HAVE EXISTING UTILITIES LOCATED. CONTRACTOR SHALL CONTACT ANY LOCAL UTILITIES THAT PROVIDE THEIR OWN LOCATOR SERVICES INDEPENDENT OF "811". REPORT ANY DISCREPANCIES TO THE ENGINEER IMMEDIATELY.

PRELIMINARY NOT FOR CONS

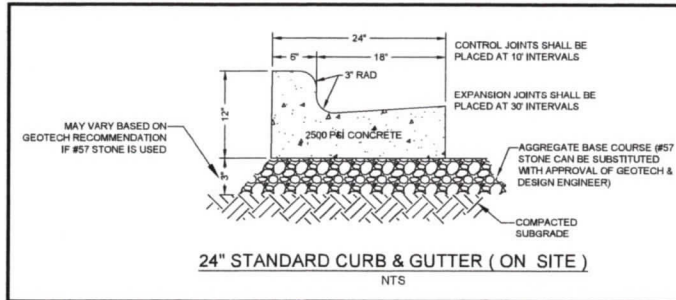

24" STANDARD CURB & GUTTER (ON SITE)
NTS

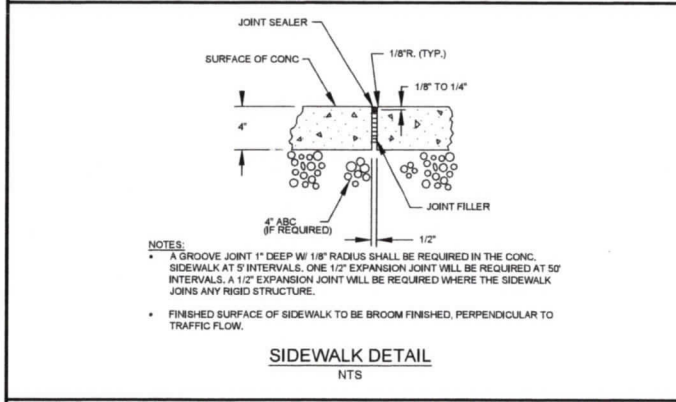

SIDEWALK DETAIL
NTS

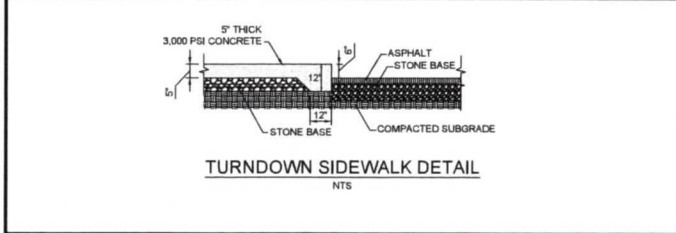

TURNDOWN SIDEWALK DETAIL
NTS

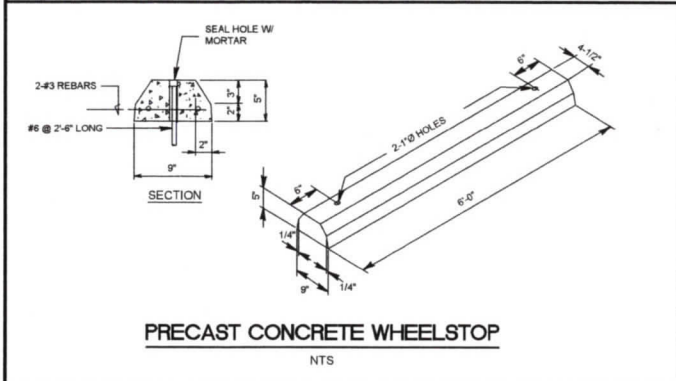

PRECAST CONCRETE WHEELSTOP
NTS

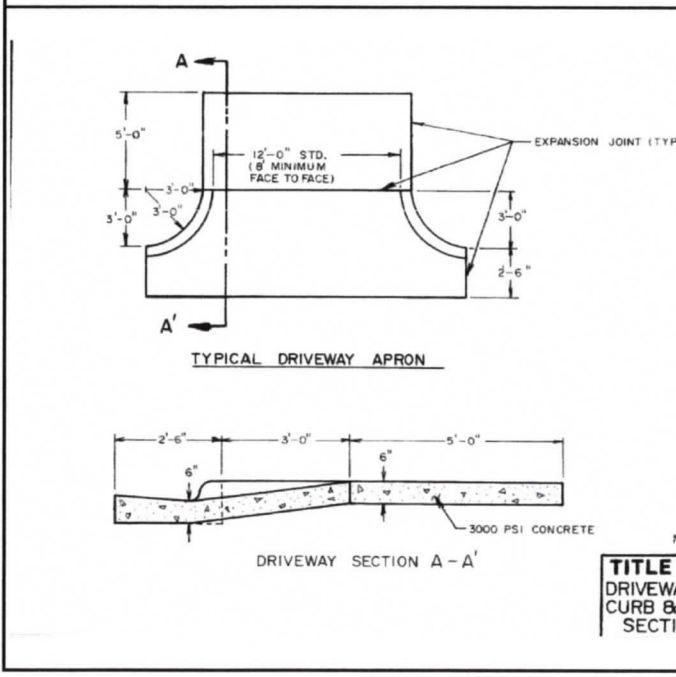

TYPICAL DRIVEWAY APRON

DRIVEWAY SECTION A-A'

TITLE	REVISIONS	DET.NO.
DRIVEWAY RAMP - CURB & GUTTER SECTION (ALT)	NO DATE BY	D-7



R7-8E

ACCESSIBLE PARKING SIGN
NTS

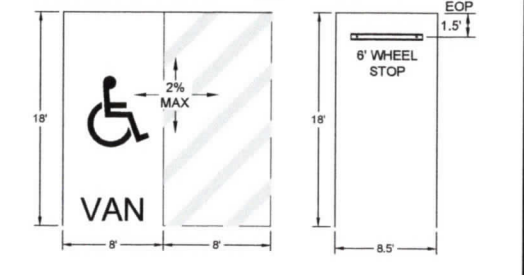

HANDICAP VAN ACCESSIBLE
REGULAR SPACE (WHEEL STOP ONLY WHERE INDICATED)

PARKING SPACES - TYPICAL

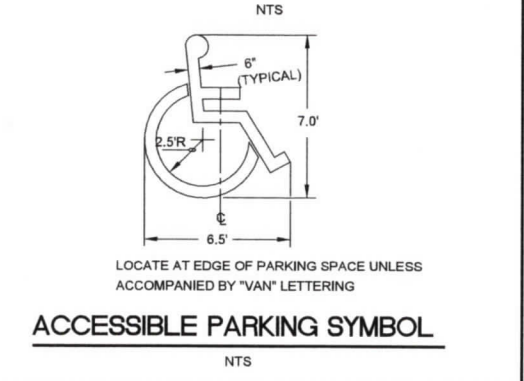

LOCATE AT EDGE OF PARKING SPACE UNLESS ACCOMPANIED BY "VAN" LETTERING

ACCESSIBLE PARKING SYMBOL
NTS

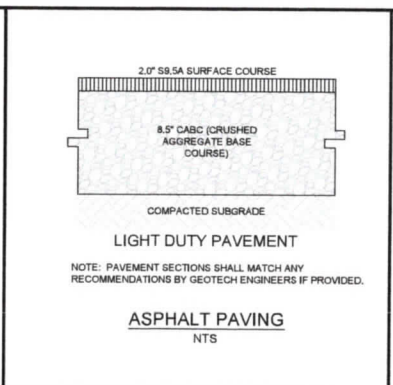

ASPHALT PAVING
NTS

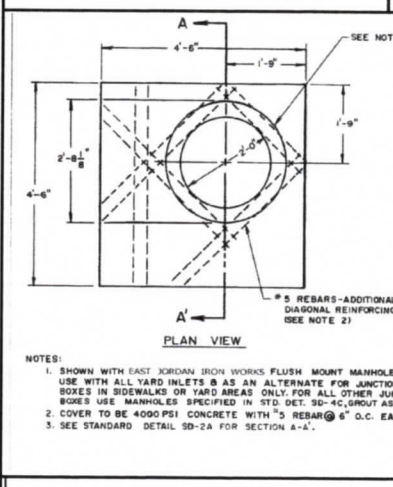

ISOMETRIC VIEW

PLAN VIEW

NOTES:
1. SHOWN WITH EAST KERRON IRON WORKS FLUSH MOUNT MANHOLE FOR USE WITH ALL YARD INLETS & AS AN ALTERNATE FOR JUNCTION BOXES IN SIDEWALKS OR YARD AREAS ONLY. FOR ALL OTHER JUNCTION BOXES USE MANHOLES SPECIFIED IN STD. DET. SD-4C, GROUT AS SHOWN.
2. COVER TO BE 4000 PSI CONCRETE WITH #5 REBAR @ 6" O.C. EACH WAY.
3. SEE STANDARD DETAIL SD-2A FOR SECTION A-A'.

TITLE	REVISIONS	DET.NO.
YARD INLET / JUNCTION BOX	NO DATE BY	SD-2

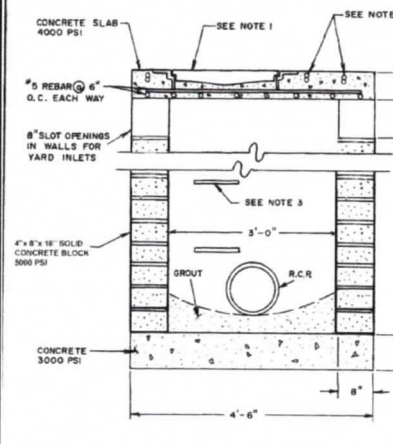

TITLE	REVISIONS	DET.NO.
YARD INLET	NO DATE BY	SD-2A

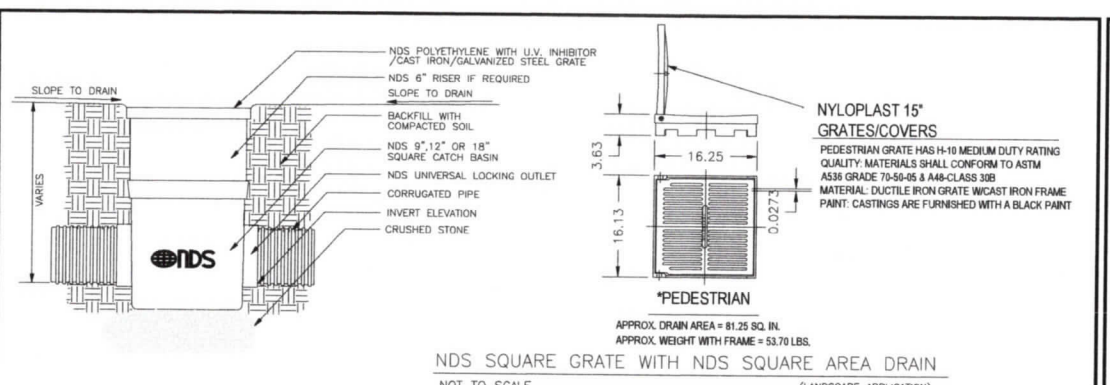

PEDESTRIAN

NDS SQUARE GRATE WITH NDS SQUARE AREA DRAIN
NOT TO SCALE (LANDSCAPE APPLICATION)

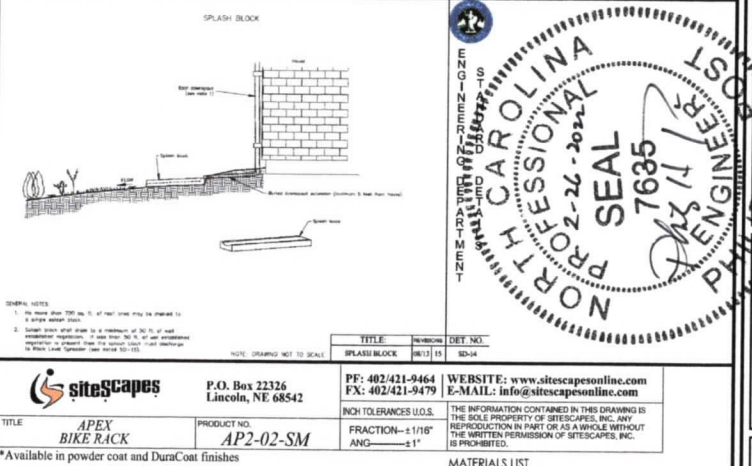

AP2-02-SM

TITLE	REVISIONS	DET.NO.
YARD INLET / JUNCTION BOX	NO DATE BY	SD-2

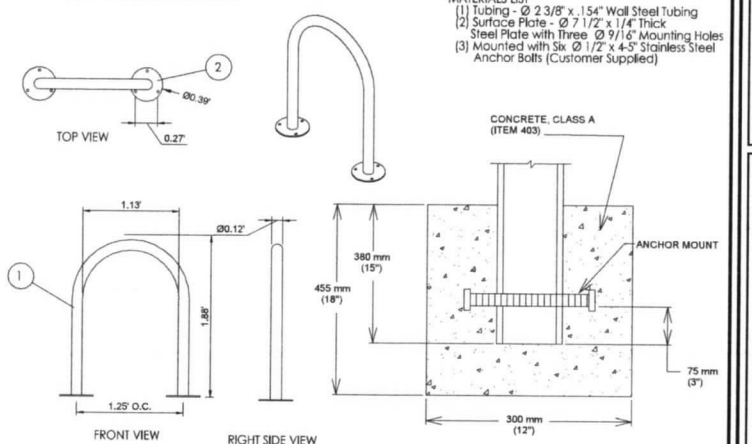

FRONT VIEW
RIGHT SIDE VIEW

TITLE	REVISIONS	DET.NO.
YARD INLET	NO DATE BY	SD-2A

STANDARD ENGINEERING DEPARTMENT

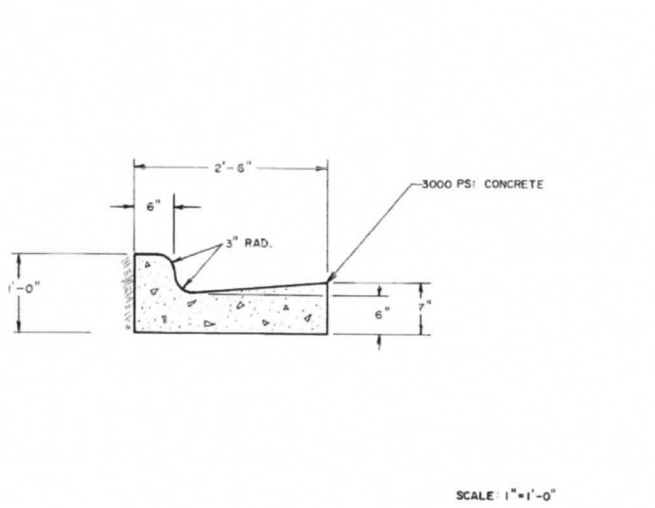

TITLE	REVISIONS	DET.NO.
CURB & GUTTER SECTION	NO DATE BY	ST-2

STANDARD ENGINEERING DEPARTMENT

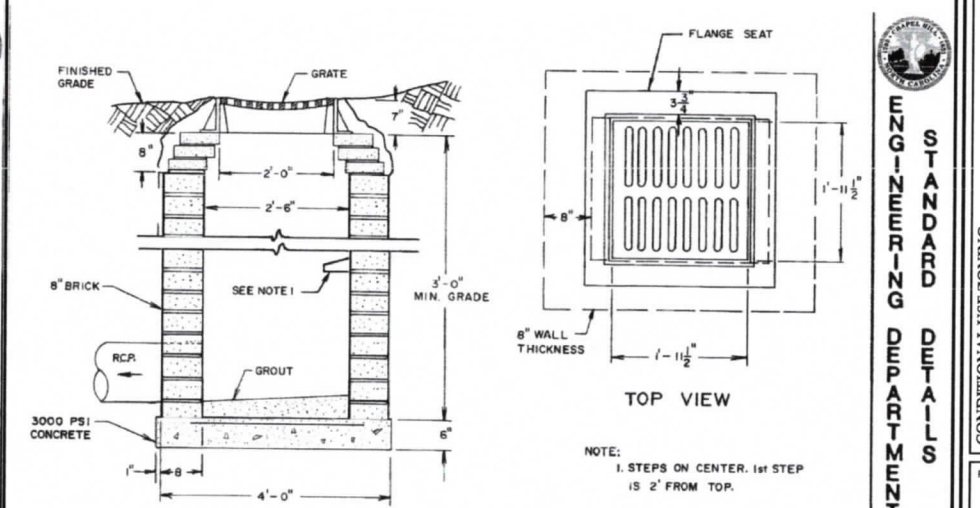

TITLE	REVISIONS	DET.NO.
CATCH BASIN - TOP VIEW & SIDE VIEW	NO DATE BY	SD-6

PRELIMINARY NOT FOR CONSTRUCTION

NO.	DATE	BY
7		
6		
5		
4		
3	2/28/2022	DMC
2	1/14/2022	DMC
1		

PHILIP POST ENGINEERING
7635
SEAL
7635
NORTH CAROLINA PROFESSIONAL SEAL
PHILIP N. POST, PE, PLS

Philip N. Post, PE, PLS
(919) 818-7862
philip.n.post@gmail.com
PO Box 4912
Chapel Hill, NC 27515

CONDITIONAL USE ZONING
PEACH APARTMENTS
107 & 107AIB JOHNSON STREET - PH: 9788-03-2946, 9788-03-0689 & 9788-03-0640
CHAPEL HILL, NORTH CAROLINA

PROJECT NO.
PEACH
DRAWING NAME:
PEACH_D.dwg
SHEET NO.
D-1

PERMANENT SEEDING IN NORTH CAROLINA (TABLE 6.11)

SEEDING MIXTURE SPECIES	RATE (LB/ACRE)
TALL FESCUE	20
SERICEA LESPEDEZA	20
KOBE LESPEDEZA	50

SEEDING NOTES:
 1. AFTER AUGUST 15 USE UNSCARIFIED SERICEA SEED.
 2. WHERE PERIODIC MOWING IS PLANNED OR A NEAR APPEARANCE IS DESIRED, OMIT SERICEA AND INCREASE KOBE LESPEDEZA TO 40 LB/ACRE.
 3. TO EXTEND SPRING SEEDING DATES INTO JUNE, ADD 15 LB/ACRE HILLED BERMUDAGRASS. HOWEVER, AFTER MID-APRIL, IT IS PREFERABLE TO SEED TEMPORARY COVER.

NURSE PLANTS:
 BETWEEN MAY 1 AND AUGUST 15, ADD 10 LB/ACRE GERMAN MILLET OR 15 LB/ACRE SUDANGRASS. PRIOR TO MAY 1 OR AFTER AUGUST 15 ADD 40 LB/ACRE RYE (GRAIN).

SEEDING DATES:

	BEST	POSSIBLE
FALL	AUGUST 25 - SEPTEMBER 15	AUGUST 20 - OCTOBER 25
LATE WINTER	FEBRUARY 15 - MARCH 21	FEBRUARY 1 - APRIL 15

FALL IS BEST FOR ALL FESCUE AND LATE WINTER FOR LESPEDEZAS. OVER SEEDING OF KOBE LESPEDEZA OVER FALL-SEEDED TALL FESCUE IS VERY EFFECTIVE.

SOIL AMENDMENTS:
 APPLY LIME AND FERTILIZER ACCORDING TO SOIL TESTS, OR APPLY 4,000 LB/ACRE GROUND AGRICULTURAL LIMESTONE AND 1,000 LB/ACRE 10-10-10 FERTILIZER.

MULCH:
 APPLY 4,000 LB/ACRE GRASS STRAW OR EQUIVALENT COVER OF ANOTHER SUITABLE MULCH. ANCHOR STRAW BY TACKING WITH ASPHALT, NETTING OR BY CROWING WITH A MULCH ANCHORING TOOL. A DISK WITH BLADES SET NEARLY STRAIGHT CAN BE USED AS A MULCH ANCHORING TOOL.

MAINTENANCE:
 RESEED, FERTILIZE AND MULCH DAMAGED AREAS IMMEDIATELY.

SEEDING SCHEDULE

- 1.) CHISEL COMPACTED AREAS AND SPREAD TOPSOIL 3 INCHES DEEP OVER ADVERSE SOIL CONDITIONS, IF AVAILABLE.
 - 2.) RIP THE ENTIRE AREA TO 6 INCHES DEPTH.
 - 3.) REMOVE ALL LOOSE ROCK, ROOTS, AND OTHER OBSTRUCTIONS LEAVING SURFACE REASONABLY SMOOTH AND UNIFORM.
 - 4.) APPLY AGRICULTURAL LIME, FERTILIZER, AND UNIFORMLY MIX WITH SOIL (SEE BELOW).
 - 5.) CONTINUE TILLAGE UNTIL A WELL-PULVERIZED, FIRM REASONABLY UNIFORM SEEDED IS PREPARED 4 TO 6 INCHES DEEP.
 - 6.) SEED ON A FRESHLY PREPARED SEEDED AND SEED LIGHTLY WITH SEEDING EQUIPMENT OR CULTIPACK.
 - 7.) MULCH IMMEDIATELY AFTER SEEDING.
 - 8.) INSPECT ALL SEEDED AREAS AND MAKE NECESSARY RESEEDINGS WITHIN THE PLANTING SEASON, IF POSSIBLE. STAND SHOULD BE OVER 60% DAMAGED, REESTABLISH WITH ORIGINAL LIME, FERTILIZER AND SEEDING RATES.
 - 9.) CONSULT CONSERVATION INSPECTOR OR MAINTENANCE AND FERTILIZATION AFTER PERMANENT COVER IS STABILIZED.
- * APPLY:
 AGRICULTURAL LIMESTONE - 2 TONS / ACRE (3 TONS / ACRE IN CLAY SOILS)
 FERTILIZER - 1,000 lbs / ACRE - 10-10-10
 SUPERPHOSPHATE - 500 lbs / ACRE - 20% ANALYSIS
 MULCH - 2 TONS / ACRE (5000 LBS/AC FOR STEEP SLOPES) - SMALL GRAIN STRAW
 ANOTHER - ASPHALT EMULSION @ 300 GALS / ACRE

SEEDBED PREPARATION

MAINTENANCE:
 NEW SEEDLINGS SHOULD BE INSPECTED FREQUENTLY AND MAINTENANCE PERFORMED AS NEEDED. IF RILLS AND GULLIES DEVELOP, THEY MUST BE FILLED, RE-SEEDED, AND MULCHED AS SOON AS POSSIBLE. DIVERSIONS MAY BE NEEDED UNTIL NEW PLANTS TAKE HOLD.
 DAMAGE TO VEGETATION FROM DISEASE, INSECTS, TRAFFIC, ETC., CAN OCCUR AT ANY TIME. HERBICIDES AND REGULAR MOWING MAY BE NEEDED TO CONTROL WEEDS, DUST AND SPRAYS MAY BE NEEDED TO CONTROL INSECTS.
 WEEK OR DAMAGED SPOTS MUST BE REIMED, FERTILIZED, MULCHED, AND RESEEDED AS PROMPTLY AS POSSIBLE.

TEMPORARY SEEDING IN NORTH CAROLINA

SEEDING MIXTURE SPECIES	RATE (LB/ACRE)
RYE (GRAIN)	120
ANNUAL LESPEDEZA (KOBE IN PIEDMONT AND COASTAL PLAIN, KOREAN IN MOUNTAINS)	50
GERMAN MILLET	40
OMIT ANNUAL LESPEDEZA WHEN DURATION OF TEMPORARY COVER IN THE PIEDMONT AND MOUNTAINS, A SMALL-STEMMED SUDAGRASS	
RYE (GRAIN)	120
IS NOT TO EXTEND BEYOND JUNE, MAY BE SUBSTITUTED AT A RATE OF 50 LB/ACRE.	

SEEDING DATES:

SEASON	REGION	DATE RANGE
LATE WINTER & EARLY SPRING	MOUNTAINS -	ABOVE 2500 FT. FEB. 15 - MAY 15
	PIEDMONT -	BELOW 2500 FT. FEB. 1 - MAY 1
	COASTAL PLAIN -	DEC. 1 - APR. 15
SUMMER	MOUNTAINS -	MAY 15 - AUG. 15
	PIEDMONT -	MAY 1 - AUG. 15
	COASTAL PLAIN -	APR. 15 - AUG. 15
FALL	MOUNTAINS -	AUG. 15 - DEC. 15
	COASTAL PLAIN AND PIEDMONT -	AUG. 15 - DEC. 30

SOIL AMENDMENTS:
 FOLLOW RECOMMENDATIONS OF SOIL TESTS OR APPLY 2,000 LB/ACRE GROUND AGRICULTURAL LIMESTONE AND 750 LB/ACRE 10-10-10 FERTILIZER.

MULCH:
 APPLY 4,000 LB/ACRE STRAW. ANCHOR STRAW BY TACKING WITH ASPHALT, NETTING OR A MULCH ANCHORING TOOL. A DISK WITH BLADES SET NEARLY STRAIGHT CAN BE USED AS A MULCH ANCHORING TOOL.

MAINTENANCE:
 RESEED IF GROWTH IS NOT FULLY ADEQUATE. RESEED, FERTILIZE AND MULCH IMMEDIATELY FOLLOWING EROSION OR OTHER DAMAGE.

CONCRETE WASHOUT PIT

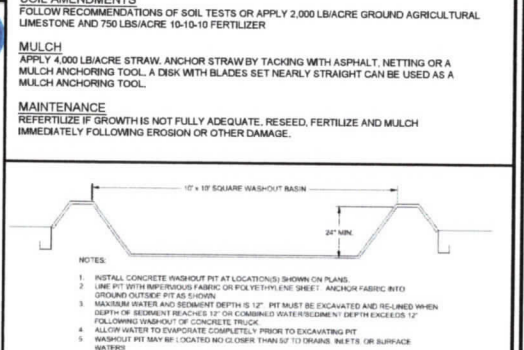

PRELIMINARY NOT FOR CONSTRUCTION

PROJECT NO. PEACH
 DRAWING NAME: PEACH_D.dwg
 SHEET NO. D-2

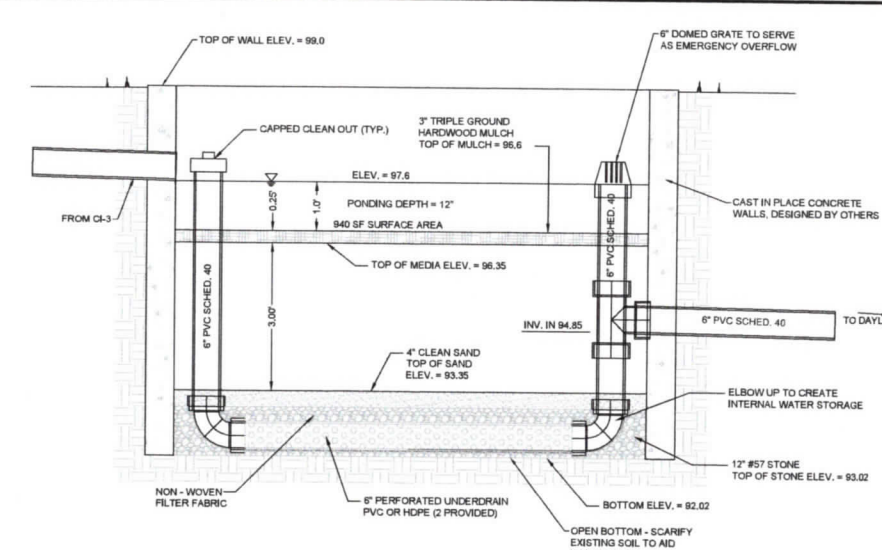

NTS

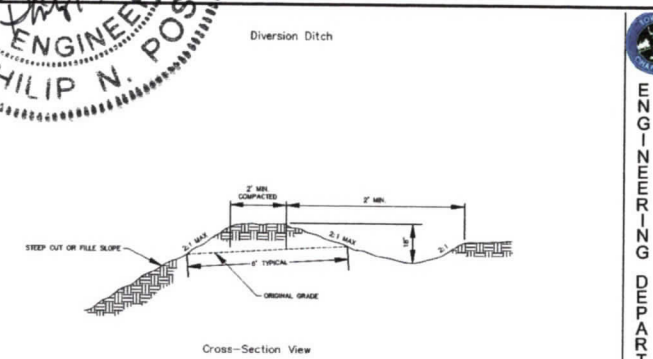
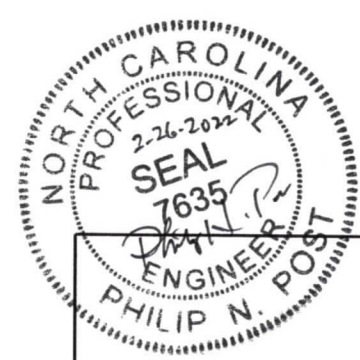

GENERAL NOTES:
 1. At a minimum, seed, straw, & tack required for site inspection approval.
 2. Stabilize diversion ditch based on design velocity.

TITLE	REVISIONS	DET. NO.
Diversion Ditch	08/13 15	SD-20

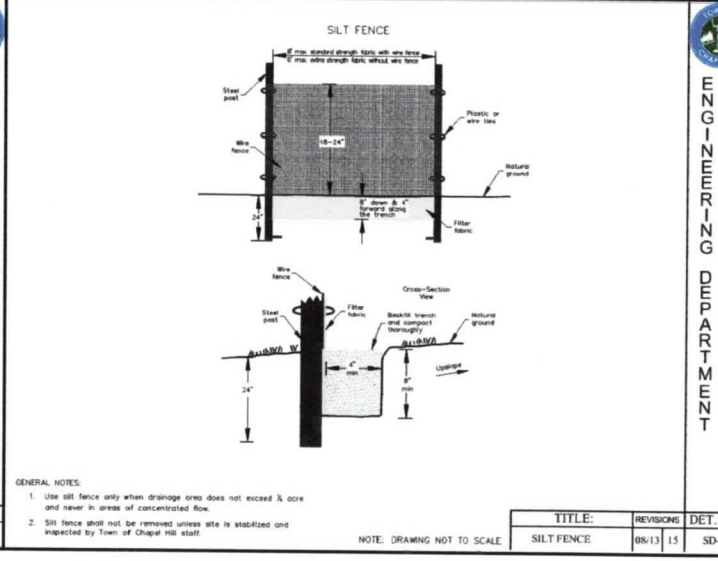

TITLE	REVISIONS	DET. NO.
SILT FENCE	08/13 15	SD-18

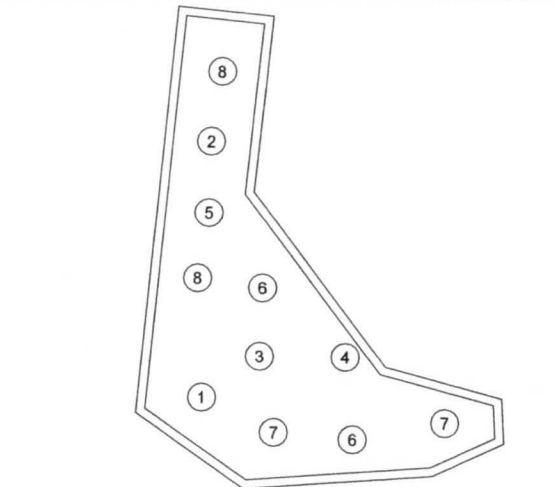

NTS

PLANT KEY:

NUMBER	QUANTITY	COMMON NAME	SCIENTIFIC NAME
1.	1	EASTERN REDBUD	CERCIS CANADENSIS
2.	1	FRINGETREE	CHIONANTHUS VIRGINICUS
3.	1	AMERICAN BEAUTYBERRY	CALLICARPA AMERICANA
4.	1	DWARF AZALEA	RHODODENDRON ATLANTICUM
5.	1	JOE PYE WEED	EUTROCHUM FISTULOSUM
6.	2	TICKSEED	COREOPSIS LANCEOLATA
7.	2	CARDINAL FLOWER	LOBELIA CARDINALIS
8.	2	SWITCHGRASS	PANICUM VIRGATUM

PLANT LIST

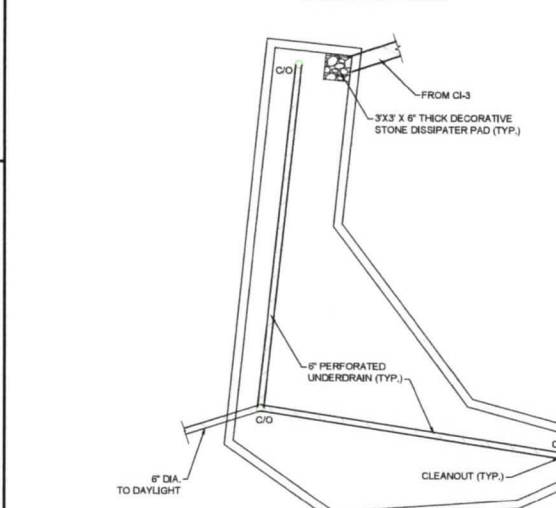

NTS

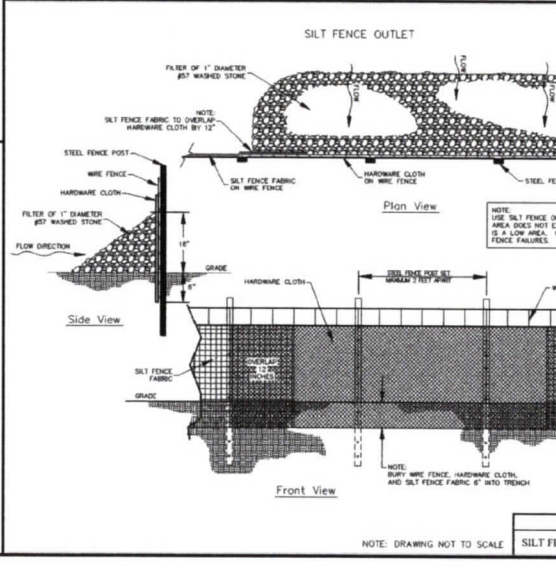

TITLE	REVISIONS	DET. NO.
SILT FENCE OUTLET	08/13 15	SD-19

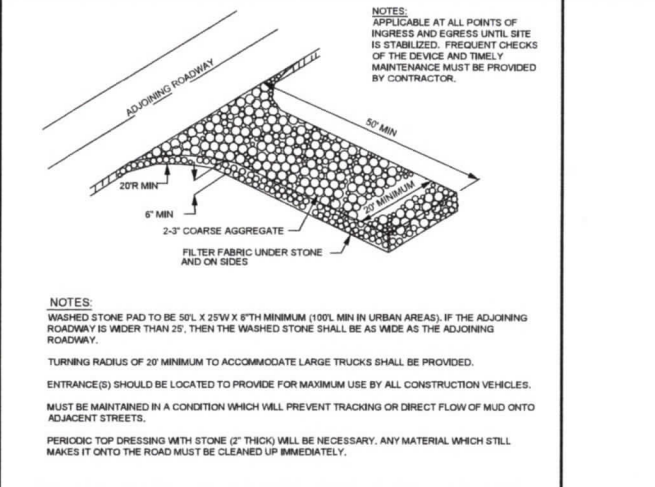

NTS

NPODES Stormwater Discharge Permit for Construction Activities (NCGO1) NCDENR/Division of Water Quality

NEW STABILIZATION TIMEFRAMES
 (Effective Aug. 3, 2011)

SITE AREA DESCRIPTION	STABILIZATION	TIMEFRAME EXCEPTIONS
Perimeter dikes, swales, ditches, slopes	7 days	None
High Quality Water (HQW) Zones	7 days	None
Slopes steeper than 3:1	7 days	If slopes are 10' or less in length and are not steeper than 2:1, 14 days are allowed.
Slopes 3:1 or flatter	14 days	7 days for slopes greater than 50' in length.
All other areas with slopes flatter than 4:1	14 days	None, except for perimeters and HQW Zones.

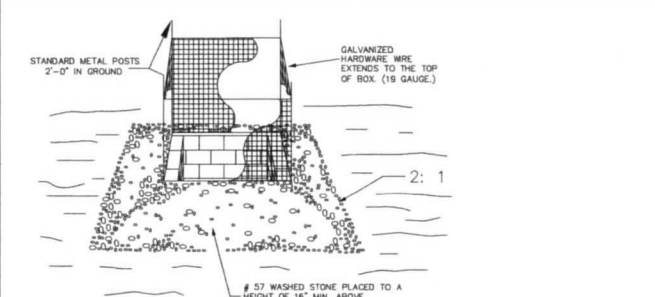

CONSTRUCTION SPECIFICATIONS:
 1. UNIFORMLY GRADE A SHALLOW DEPRESSION APPROACHING INLET.
 2. DRIVE 5' STEEL POSTS 2 FEET INTO THE GROUND SURROUNDING THE INLET. SPACE POSTS EVENLY AROUND THE PERIMETER OF THE INLET, A MAXIMUM OF 4' APART.
 3. SURROUND THE POSTS WITH WIRE MESH HARDWARE CLOTH. SECURE THE WIRE MESH TO THE STEEL POSTS AT THE TOP, MIDDLE, & BOTTOM. PLACING A 2-FT. FLAP OF THE WIRE MESH UNDER THE GRAVEL FOR ANCHORING IS RECOMMENDED.
 4. PLACE CLEAN GRAVEL (NO DOT #5 OR #57 STONE) ON A 2:1 SLOPE WITH A HEIGHT OF 16" AROUND THE WIRE, AND SMOOTH TO AN EVEN GRADE.
 5. ONCE THE CONTRIBUTING DRAINAGE AREA HAS BEEN STABILIZED, REMOVE ACCUMULATED SEDIMENT, AND ESTABLISH FINAL GRADING ELEVATIONS.
 6. COMPACT THE AREA PROPERLY AND STABILIZE IT WITH GROUND COVER.

MAINTENANCE:
 INSPECT INLETS AT LEAST WEEKLY AND AFTER EACH SIGNIFICANT (1" OR GREATER) RAINFALL EVENT. CLEAR THE WIRE MESH OF ANY DEBRIS OR OTHER OBJECTS TO PROVIDE ADEQUATE FLOW FOR SUBSEQUENT RAINS. TAKE CARE NOT TO DAMAGE OR UNDERCUT THE WIRE MESH DURING SEDIMENT REMOVAL. REPLACE STONE AS NEEDED.

LANDSCAPE PROTECTION NOTES

PRE-CONSTRUCTION CONFERENCE - PRIOR TO THE COMMENCEMENT OF ANY CONSTRUCTION ACTIVITIES A PRE-CONSTRUCTION CONFERENCE WITH TOWN'S URBAN FORESTER SHALL TAKE PLACE TO REVIEW PROCEDURES FOR PROTECTION AND MANAGEMENT OF ALL PROTECTED LANDSCAPE ELEMENTS IDENTIFIED ON THE LANDSCAPE PROTECTION PLANS.

ANY TREE ROOT EXPOSED BY CONSTRUCTION WILL BE SEVERED CLEANLY WITH A PRUNING TOOL.

NO NAILS, ROPES, CABLES, SIGNS, OR FENCING SHALL BE ATTACHED TO ANY PART OF ANY TREE THAT IS TO REMAIN.

TREES THAT ARE DAMAGED DURING CONSTRUCTION SHALL BE TREATED SO AS TO PROMOTE THEIR CONTINUED HEALTH.



NTS

NO.	DATE	BY
1	1/14/2022	DNC
2	2/26/2022	DNC

NO.	DATE	BY
1	1/14/2022	DNC
2	2/26/2022	DNC

NO.	DATE	BY
1	1/14/2022	DNC
2	2/26/2022	DNC

Philip N. Post, PE, PLS
 (919) 818-7862
 philip.n.post@gmail.com
 PO Box 4912
 Chapel Hill, NC 27515

PHILIP POST ENGINEERING
 FIRM: C-347

CONDITIONAL USE ZONING PEACH APARTMENTS
 107 & 107-AB JOHNSON STREET - P/N: 9788-03-2946, 9788-03-0899 & 9788-03-0940
 CHAPEL HILL, NORTH CAROLINA

SITE DETAILS

PROJECT NO. PEACH
 DRAWING NAME: PEACH_D.dwg
 SHEET NO. D-2



100% Grass Covered Porous Pavement

Grasspave2 Flexible Plastic Porous Pavement

Grasspave2 protects and enhances the environment in three ways: First, made from 100% recycled plastic, Grasspave2 keeps common consumer and industrial products from going into landfills. Second, grass paving directly improves the environment by recharging water tables on site (reducing flooding hazards downstream), reducing sources of oils and solvents from asphalt, absorbing carbon dioxide, and creating oxygen. Third, it enhances the beauty and quality of the built environment - replacing hot asphalt paved areas with cool, sparking green lawn-like Product Description

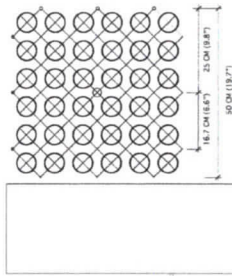

- Maximum porosity
- Low to zero runoff
- Free air/water movement
- Permits more trees
- Cooler site
- Greater oxygen
- Removes air pollutants
- Can preserve existing trees
- Helps to meet "Green Coverage Codes"
- Fast, low cost installation
- Competes in cost with asphalt paving
- No gutter and rain system needed
- No added land required for detention facilities
- Lower life cycle costs

Applications

- Church/employee parking
- Overflow and event parking
- Golf cart paths
- Residential driveways
- Firelanes

Specifications

Unit Size - 20"x 20"x 1" (50 x 50 x 2.5cm)
 Unit Weight - 18oz (510 grams)
 Strength - 15,940 psi (109,906 kPa)
 Connector Pull Apart Strength (Tensile) - 458 lb/in
 Color - Black
 Resin - 100% recycled HDPE with 3% carbon black
 Shipped in Rolls (431 sq ft standard, other roll sizes available)
 92% Void Space (8% plastic by volume)

Invisible Structures, Inc.
 303-233-8383
 www.invisiblestructures.com
 US Patent #5,250,340



The rings transfer loads from the surface to the grid structure and engineered base course material below, thus preventing compaction of the upper root zone of the grass. A single ring supports small loads, such as shoes; several rings support tires and large loads.

The rings also act to contain the root zone medium (sand) and prevent lateral migration away from tires, feet, or other loads. This protects the grass root system, enabling roots to grow deep into the porous base course. The result is healthy, green turf at the surface.

Features and Benefits

- Allows 100% grass coverage instead of asphalt
- Made from 100% post consumer plastic
- High strength to weight load-bearing capacity
- Supports vehicular and pedestrian traffic



NOTES:

1. THIS COMPLES WITH NCEQ STORMWATER DESIGN MANUAL - SECTION A-4.
2. #57 STONE AND GEOTEXTILE FABRIC MAY NOT BE PLACED ON IMPERVIOUS MATERIAL SUCH AS PAVEMENT OR CRUSHER RAIL.

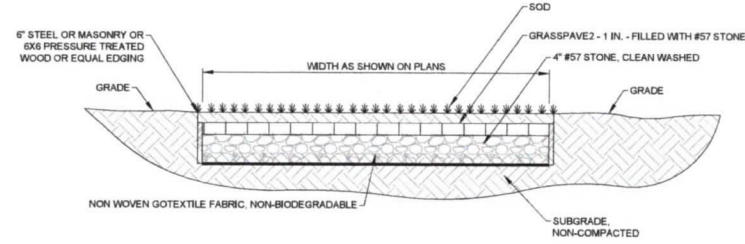

PERVIOUS GRAVEL - 100% GRASS COVERED PORUS SURFACE TYPICAL SECTION
NTS

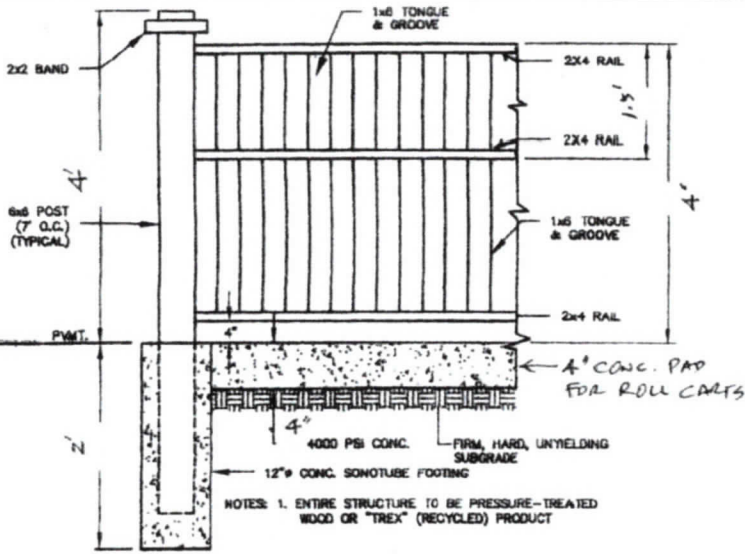

4" WOOD ROLL CART SCREEN
NTS

NOTES: 1. ENTIRE STRUCTURE TO BE PRESSURE-TREATED WOOD OR "TREX" (RECYCLED) PRODUCT



NO.	REVISIONS	DATE	BY
7			
6			
5			
4			
3			
2	TURN COMMENTS	2/26/2022	DMC
1	ISSUE ITEMS	1/14/2022	DMC

PROJECT ENGINEER
 PHILIP N. POST
 CHECKED BY
 PHILIP N. POST
 DRAWN BY
 DC
 FIRST ISSUE DATE
 07-21-2021

Philip Post Engineering, Inc. is not to be reproduced or copied in whole or in part without the written request of Philip Post Engineering, Inc. COPYRIGHT 2021

Philip N. Post, PE, PLS
 (919) 818-7862
 philip.n.post@gmail.com
 PO Box 4912
 Chapel Hill, NC 27515

PHILIP POST ENGINEERING
 FIRM: C-347

CONDITIONAL USE ZONING
PEACH APARTMENTS
 107 & 107-1/2 AB JOHNSON STREET - PIN: 9788-03-2946, 9788-03-0896 & 9788-03-0940
 CHAPEL HILL, NORTH CAROLINA

SITE DETAILS

PROJECT NO.
PEACH
 DRAWING NAME:
 PEACH_D.dwg
 SHEET NO.
D-3

**PRELIMINARY
 NOT FOR CONSTRUCTION**

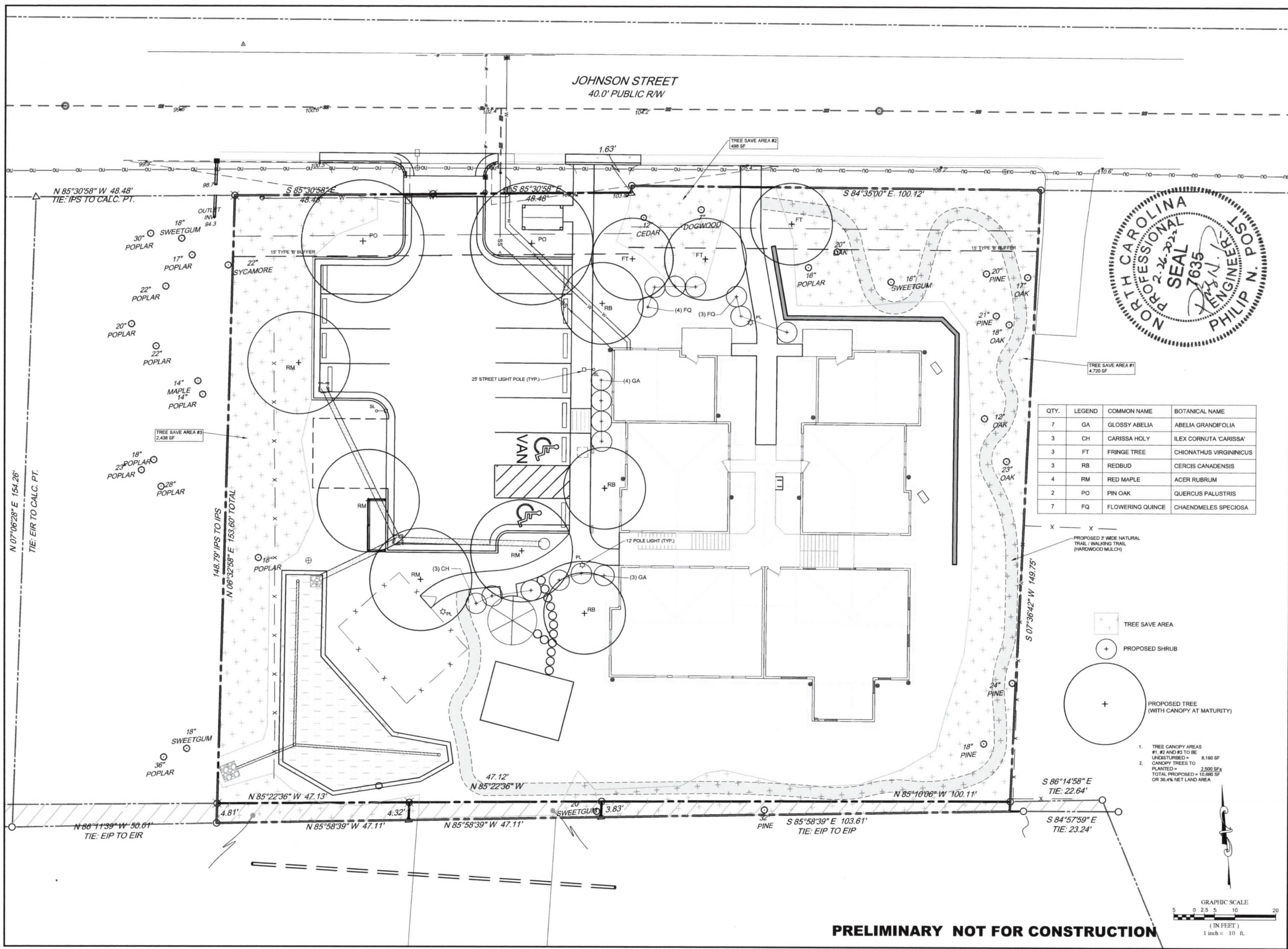

QTY.	LEGEND	COMMON NAME	BOTANICAL NAME
7	GA	GLOSSY ABELIA	ABELIA GRANDIFOLIA
3	CH	CARISSA HOLY	ILEX CORNUTA 'CARISSA'
3	FT	FRINGE TREE	CHIONATHUS VIRGINICUS
3	RB	REDBUD	CERCIS CANADENSIS
4	RM	RED MAPLE	ACER RUBRUM
2	PO	PIN OAK	QUERCUS PALUSTRIS
7	FQ	FLOWERING QUINCE	CHAENOMELES SPECIOSA

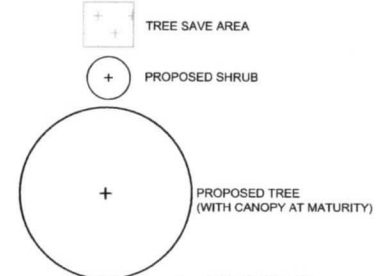

- TREE CANOPY AREAS #1, #2 AND #3 TO BE UNDISTURBED = 8,160 SF
- CANOPY TREES TO BE PLANTED = 2,500 SF
- TOTAL PROPOSED = 10,660 SF OR 35.4% NET LAND AREA

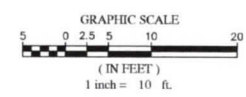

PRELIMINARY NOT FOR CONSTRUCTION

NO.	DATE	BY	REVISIONS
7			
6			
5			
4			
3			
2	1/14/2022	DHC	TOWN COMMENTS
1	7/28/2022	DHC	MISC. ITEMS

PROJECT ENGINEER
 PNP
 CHECKED BY
 PNP
 DRAWN BY
 DC
 FIRST ISSUE DATE
 07-21-2021

Philip N. Post, Inc. is the author of this drawing. It is the property of Philip N. Post, Inc. and is not to be reproduced or copied in whole or in part. It is only to be used for the specific project and site specifically identified herein and is not to be used on any other project or site. It is to be returned to Philip N. Post, Inc. upon completion of the project. Engineering, Inc. COPYRIGHT 2021

Philip N. Post, PE, PLS
 (919) 818-7862
 philip.n.post@gmail.com
 PO Box 4912
 Chapel Hill, NC 27515

PHILIP POST ENGINEERING
 FIRM: C-347

CONDITIONAL USE ZONING
PEACH APARTMENTS
 107 & 107-AB JOHNSON STREET - PIN: 9788-03-2946, 9788-03-0899 & 9788-03-0940
 CHAPEL HILL, NORTH CAROLINA

LANDSCAPE PLAN

PROJECT NO.
PEACH
 DRAWING NAME:
 L-1 LANDSCAPE PLAN.dwg
 SHEET NO.
L-1

JOSH GURLITZ ARCHITECTS
 HA NGO DESIGN PRINCIPAL
 308 WEST ROSEMARY STREET, SUITE 302
 CHAPEL HILL, NC 27516
 919.929.7595 F.919.967.9636

PHIL POST ENGINEERING

**EMPOWERMENT
 MIDWAY CENTER
 CHAPEL HILL, NC
 JOHNSON ST.
 HOUSING**

ISSUE / REVISION	DATE	NO.

COPYRIGHT © 2019,
 JOSH GURLITZ ARCHITECTS (JGA)
 ALL RIGHTS RESERVED
 NO PART OF THESE PLANS MAY BE COPIED, REPRO-
 DUCED OR REUSED IN ANY WAY WITHOUT THE EXPRESS
 WRITTEN PERMISSION OF JGA ARCHITECTS.

January 12, 2021

**BUILDING
 PLAN
 GROUND FLOOR**

Project Number:
 Scale: $\frac{3}{16}'' = 1'-0''$
 Date:
 Sheet Number:

A-1.2

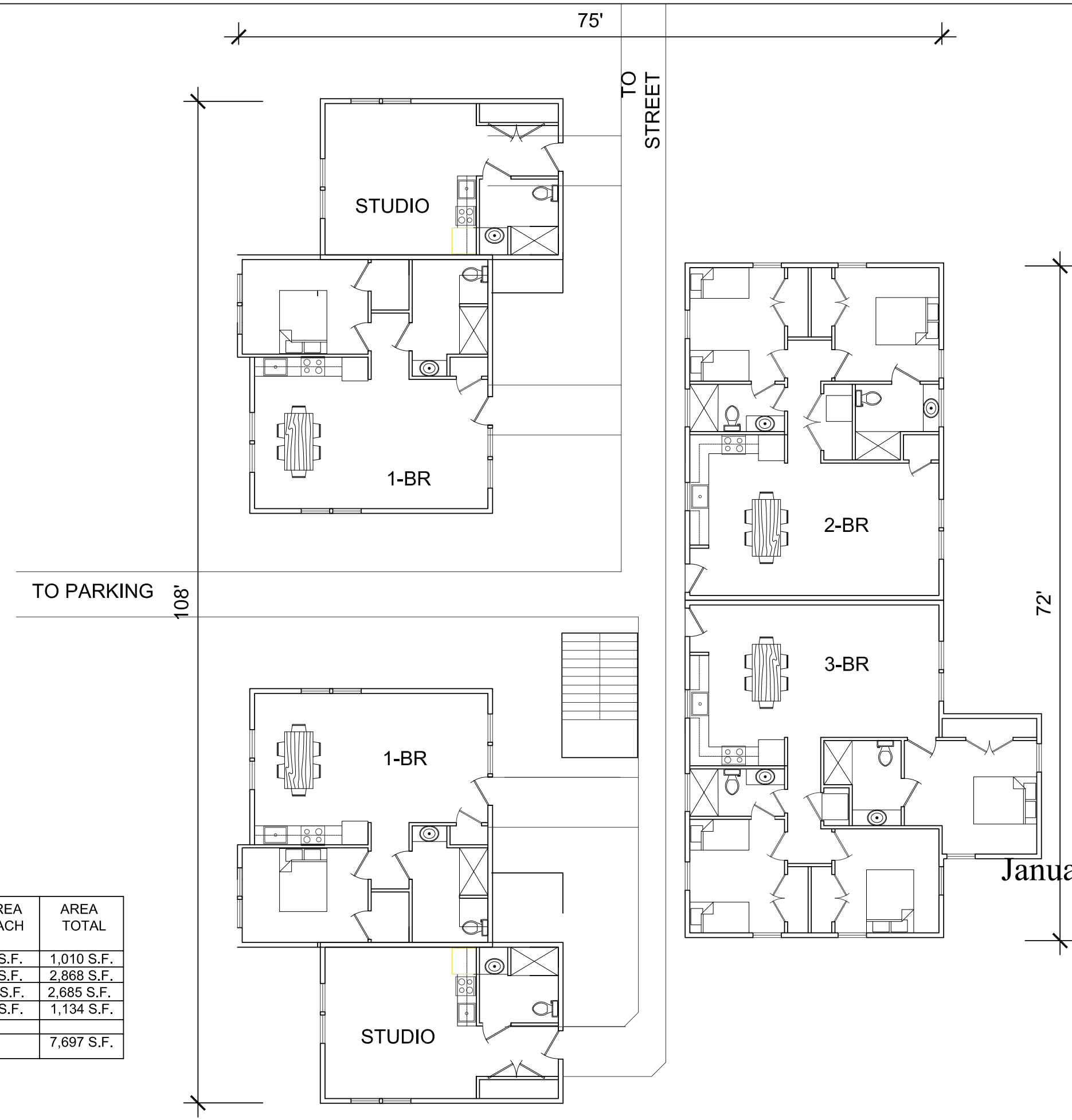

BUILDING METRICS

UNIT TYPE	No	LUMO REQ'D AREA 3.10.2	AREA EACH	AREA TOTAL
EFFICIENCY	2	500	505 S.F.	1,010 S.F.
1 BEDROOM	4	700	717 S.F.	2,868 S.F.
2 BEDROOM	3	850	895 S.F.	2,685 S.F.
3 BEDROOM	1	1,100 S.F.	1,134 S.F.	1,134 S.F.
TOTAL				7,697 S.F.

JOSH GURLITZ ARCHITECTS
 HA NGO DESIGN PRINCIPAL
 308 WEST ROSEMARY STREET, SUITE 302
 CHAPEL HILL, NC 27516
 919.929.7595 F.919.967.9636

PHIL POST ENGINEERING

**EMPOWERMENT
 MIDWAY CENTER
 CHAPEL HILL, NC
 JOHNSON ST.
 HOUSING**

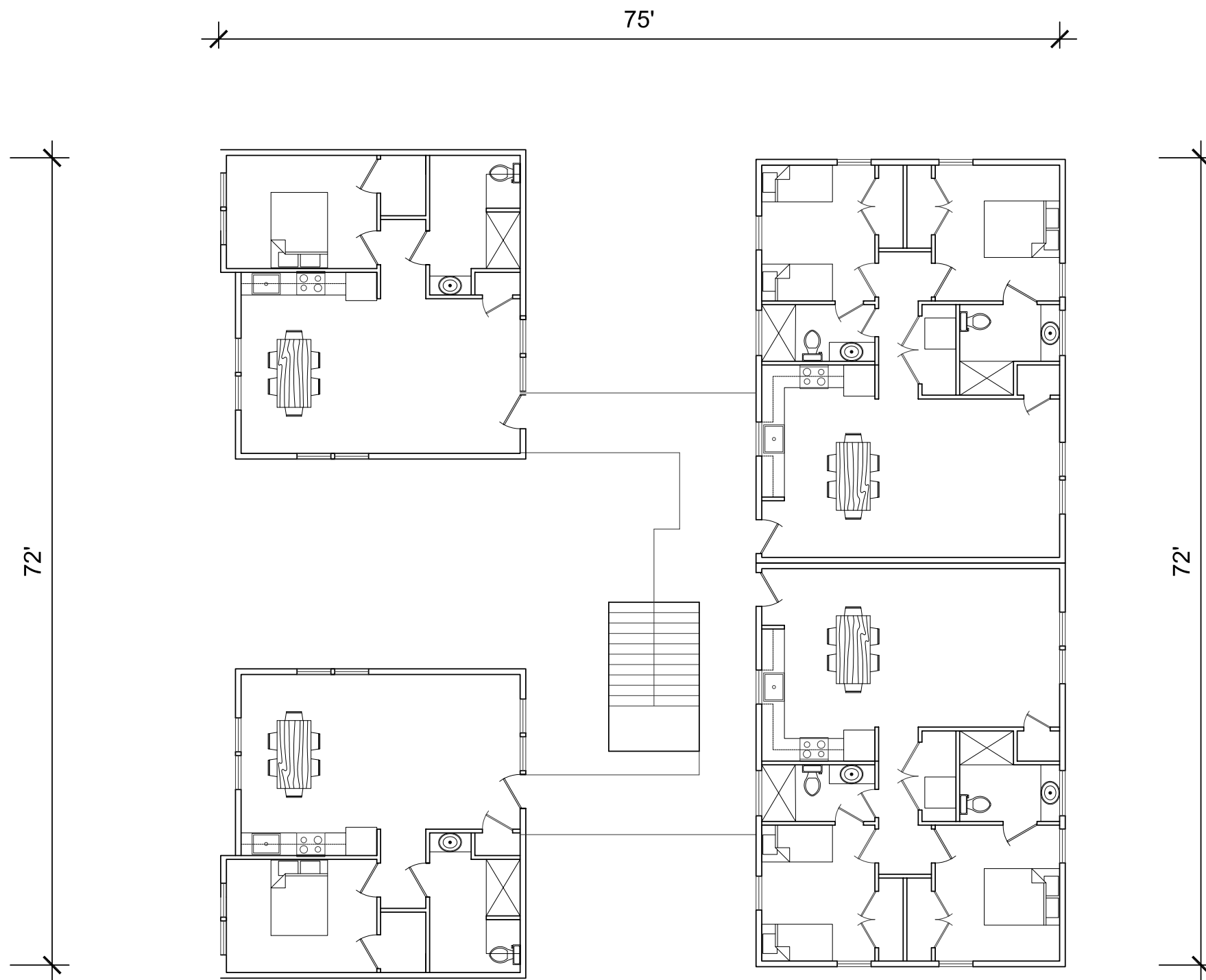

**SECOND FLOOR
 BUILDING PLAN**

January 12, 2021

ISSUE / REVISION	DATE	NO.

COPYRIGHT © 2019,
 JOSH GURLITZ ARCHITECTS (JGA)
 ALL RIGHTS RESERVED
 NO PART OF THESE PLANS MAY BE COPIED, REPRODUCED OR REUSED IN ANY WAY WITHOUT THE EXPRESS WRITTEN PERMISSION OF JGA ARCHITECTS.

**BUILDING
 PLAN
 SECOND FLOOR**

Project Number:
 Scale: $\frac{3}{16}'' = 1'-0''$
 Date:
 Sheet Number:

A-2.2

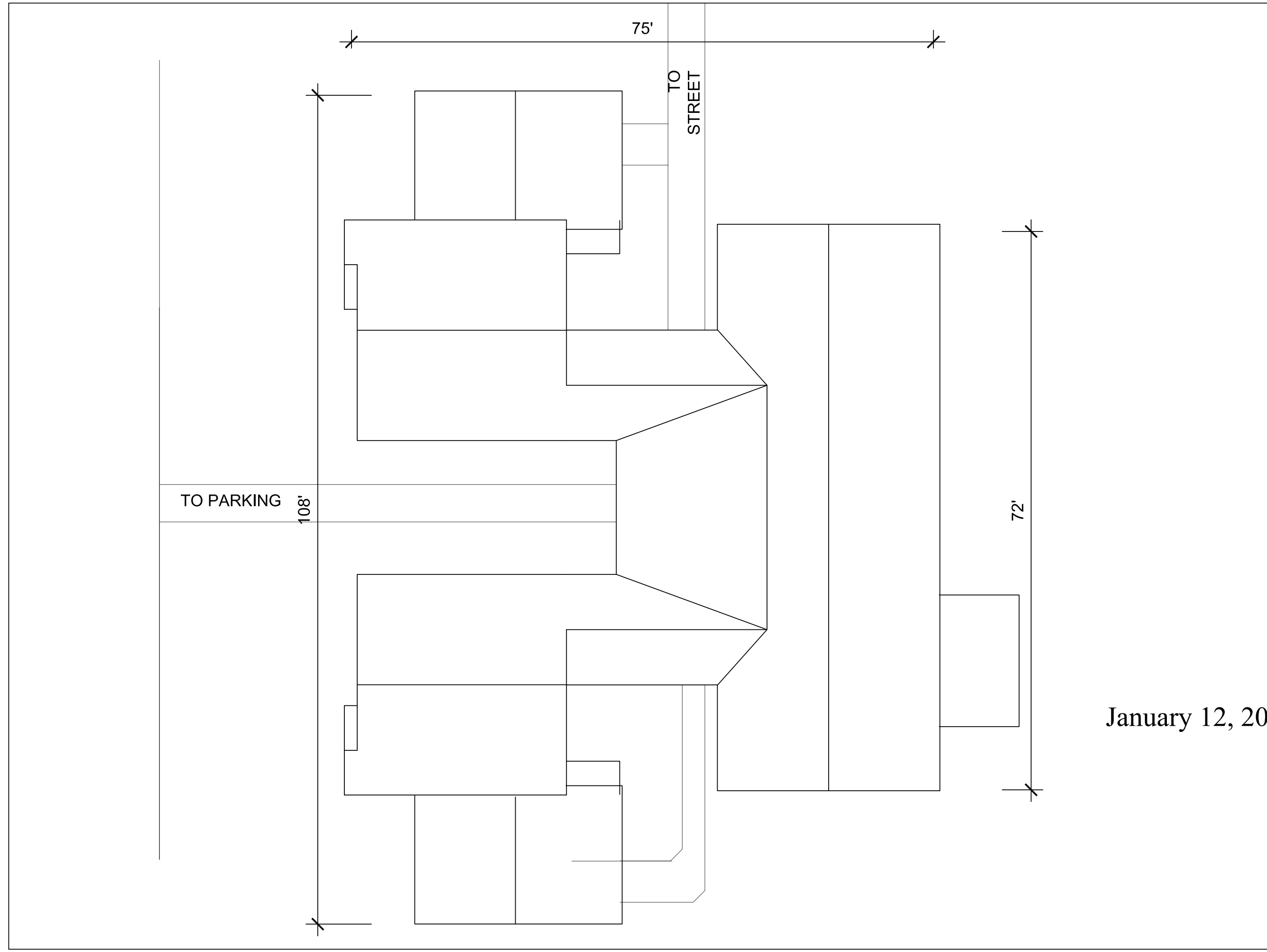

JOSH GURLITZ ARCHITECTS
 HA NGO DESIGN PRINCIPAL
 308 WEST ROSEMARY STREET, SUITE 302
 CHAPEL HILL, NC 27516
 919.929.7595 F.919.967.9636

PHIL POST ENGINEERING

EMPOWERMENT
MIDWAY CENTER
CHAPEL HILL, NC
JOHNSON ST.
HOUSING

ISSUE / REVISION	DATE	NO.

COPYRIGHT © 2019,
 JOSH GURLITZ ARCHITECTS (JGA)
 ALL RIGHTS RESERVED
 NO PART OF THESE PLANS MAY BE COPIED, REPRO-
 DUCED, OR REUSED IN ANY WAY WITHOUT THE EXPRESS
 WRITTEN PERMISSION OF JGA ARCHITECTS.

January 12, 2021

ROOF
 PLAN

Project Number:
 Scale: $\frac{3}{16}'' = 1'-0''$
 Date:
 Sheet Number:

A-2.2

EMPOWERMENT
MIDWAY CENTER
CHAPEL HILL, NC
JOHNSON ST.
HOUSING



EAST ELEVATION



NORTH ELEVATION



WEST ELEVATION



SOUTH ELEVATION

ISSUE/REVISION	DATE	NO.

COPYRIGHT © 2019,
 JOSH GURLITZ ARCHITECTS (JGA)
 ALL RIGHTS RESERVED
 NO PART OF THESE PLANS MAY BE COPIED, REPRODUCED OR REUSED IN ANY WAY WITHOUT THE EXPRESS WRITTEN PERMISSION OF JGA ARCHITECTS.

BUILDING ELEVATIONS

Project Number:
 Scale: **AS NOTED** $\frac{3}{16}'' = 1'-0''$
 Date:
 Sheet Number:

A-3.1

**PHILIP
POST
ENGINEERING**

ENGINEERS
PLANNERS
SURVEYORS

104 St. Andrews Place
Chapel Hill, NC 27517

PO Box 4912
Chapel Hill, NC 27515-4912

FIRM: C-347

TO:	Kumar Neppalli, PE
FROM:	Philip Post, PE
DATE:	March 23, 2021
RE:	Request for Exemption from Traffic Study Peach Apartments – Rezoning and CUZ 107 Johnson Street



Empowerment, Inc on behalf of their proposed 100% affordable, 10-unit apartment housing project on Johnson Street, respectfully requests that the Town exempt this application from a traffic impact analysis.

The site, until the building was recently demolished, contains a 1056 sf community building and a playground/ basketball court with off street parking for four cars.

Empowerment, Inc has acquired interest in Pin Numbers: 9788-03-2946/0899 and 0940, about 0.74 acres (GLA) at 107 Johnson St. Empowerment, Inc intends to submit a Rezoning and Conditional Use Zoning application in June of 2021. Empowerment, Inc hopes to gain approval for ten, 100% affordable apartments (two efficiencies, four one bedroom, three two bedroom, one three bedroom) (total of 7,697 sf)with eleven paved off street parking spaces and two off street overflow spaces.

CCC firmly believes this request for exemption meets the five (5) criteria of the Town:

1) Daily Trip Generation less than 500:

I estimate from ITE Trip Generation the existing 495 use for Saturday is 8 trips and for Sunday is 15 trips. I estimate from ITE Trip Generation the proposed 253 use for Saturday is 25 trips and for Sunday is 27 trips. Therefore, the trip increase due to the change in use is 17 trips for Saturday and 12 trips for Sunday, which are both far, far less than 500.

2) No More than 250 vehicles Per Day access onto a Collector Road:

Johnson Street is a Local road, therefore not applicable.

3) Total Traffic Not Exceed 150 on a Gravel Road:

Johnson St is paved, therefore not applicable.

4) Applicant submits a written request for TIA Waiver:

This document is the request for a waiver.

5) The Town Manager Concur with the request:

Empowerment, Inc respectfully asks the Town Manager to approve this waiver.

Since this request fully complies with the five (5) requirements in the Town guidelines, we sincerely ask that the requested waiver be granted.

Attachments: Concept Site Plan (9 Sheets)