

# Eastowne Conditional Zoning

Town Council

May 24, 2023



# Summary of Work Since Opening Public Hearing

---

- Continued discussion on parking needs and the Northern 20 acres
- Community Benefits
- Finalizing the site specific ordinance

# Eastowne Development at Full Build Out with Parking on N20 (if required)



## Northern 20 acres (N20)

---

UNC Health will place a minimum of 10 acres in to perpetual preservation

UNC Health have accepted an easement request from ToCH for a potential future road across the N20 (stip. #52)

Maximum 1,200-space parking structure, shall be subsequently authorized by the Town Manager upon demonstration of additional need to include:

- Surveys of existing parking lot utilization with documentation provided by UNCH of vehicular parking utilization at peak hours, number of staff on-site, number of patients, and use of bicycle parking spaces
- If peak hour utilization of the vehicular parking spaces exceed 80% of the capacity, a parking structure to provide the additional parking necessary to meet the overall demonstrated need for the Eastowne development will be approved on the N20

# Community Benefit

---

UNC Health presented the following community benefit options to the Town:

- \$5M 20-year loan at 0% interest

## Loan Opportunity Cost

- Using a 6% annual rate of return, a 20-year \$5M loan would cost UNC Health ~\$11M in opportunity costs:
  - UNC Health would otherwise use the \$5M to invest in improving healthcare delivery
  - The ~\$11M in appreciation is occurring during a time that UNC Health is experiencing increasing costs and capital needs relative to cash available
  - These factors affect UNC Health's ability to continue providing affordable care to the community

*Note: In 2022, UNC Health provided ~\$34M in unreimbursed care to patients within the Town of Chapel Hill*

*Each year, UNC Health and/or its subsidiaries directly pay (payments in-lieu) and indirectly pay (reimbursement of property taxes to third-party landlords) ~\$1.6M to Orange County and the Town of Chapel Hill*

## Action Requested

---

Vote of approval by Council for the Conditional Zoning application

# Questions & Discussion

# Appendix





# Eastowne Development Proposed Signage Increase

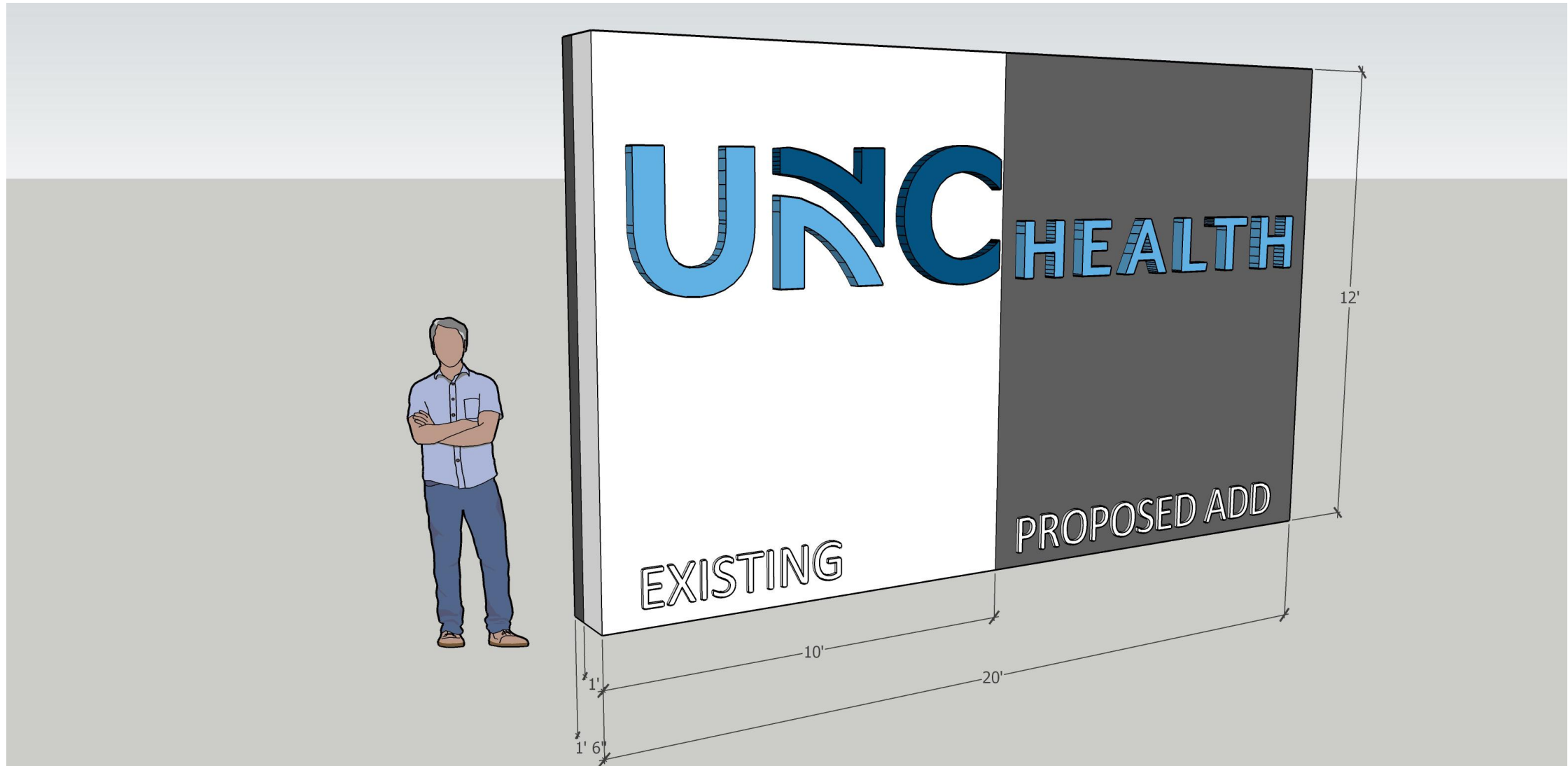

\* This is a diagram, not a design. Color variations are only meant to exemplify the existing allowable size vs. the proposed sign area.

# New Hope Connector

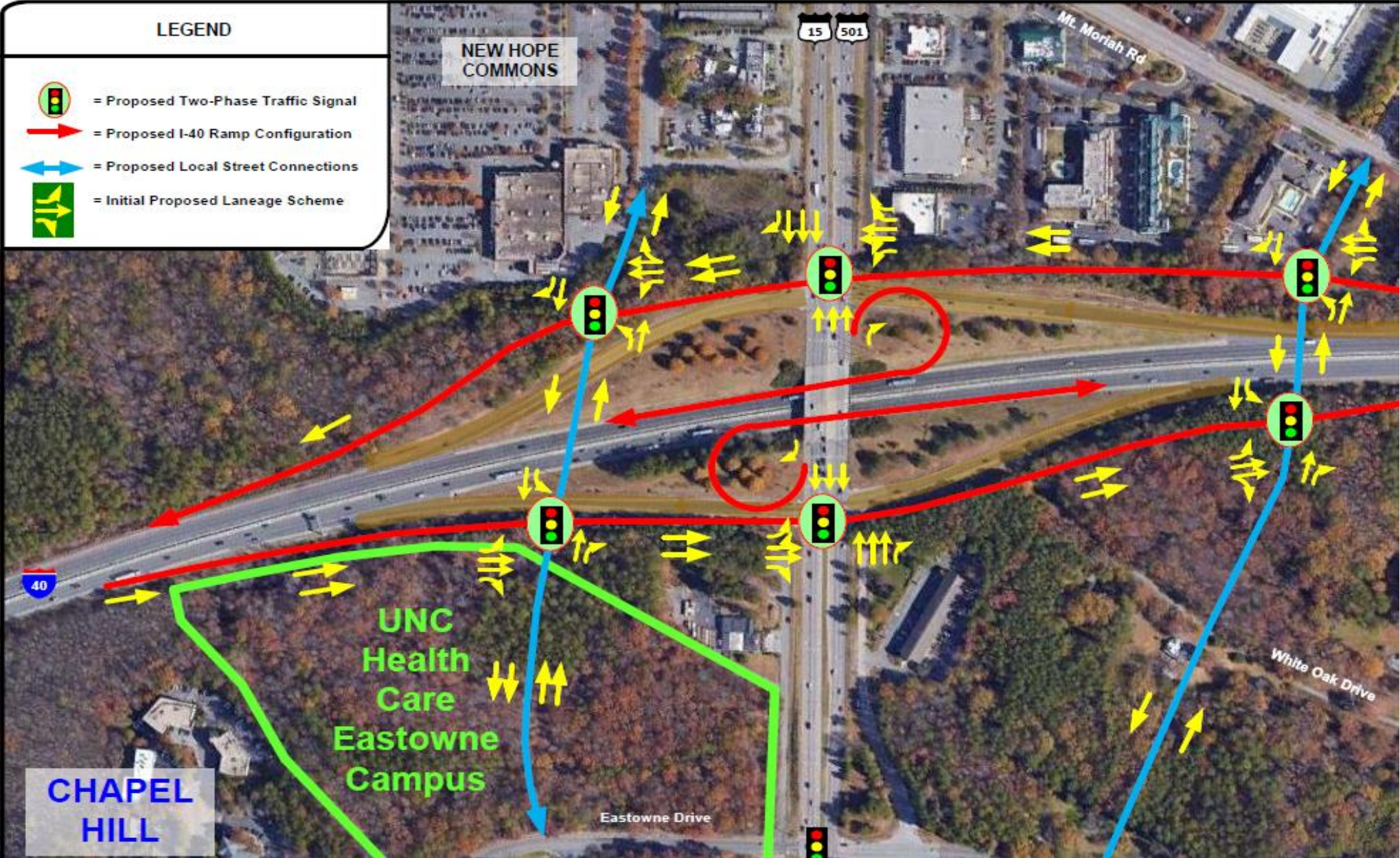

# New Hope Connector

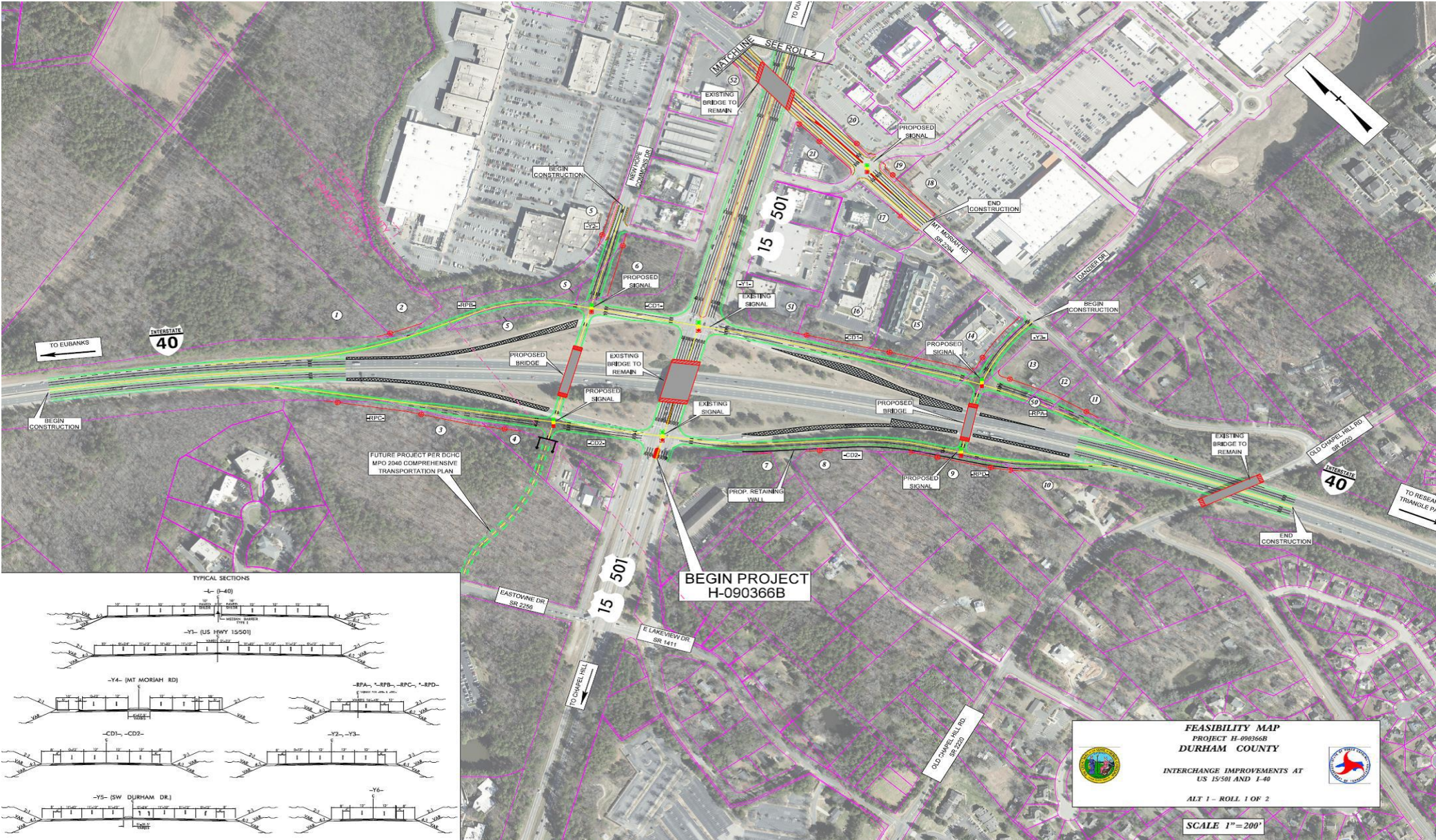

# New Hope Connector

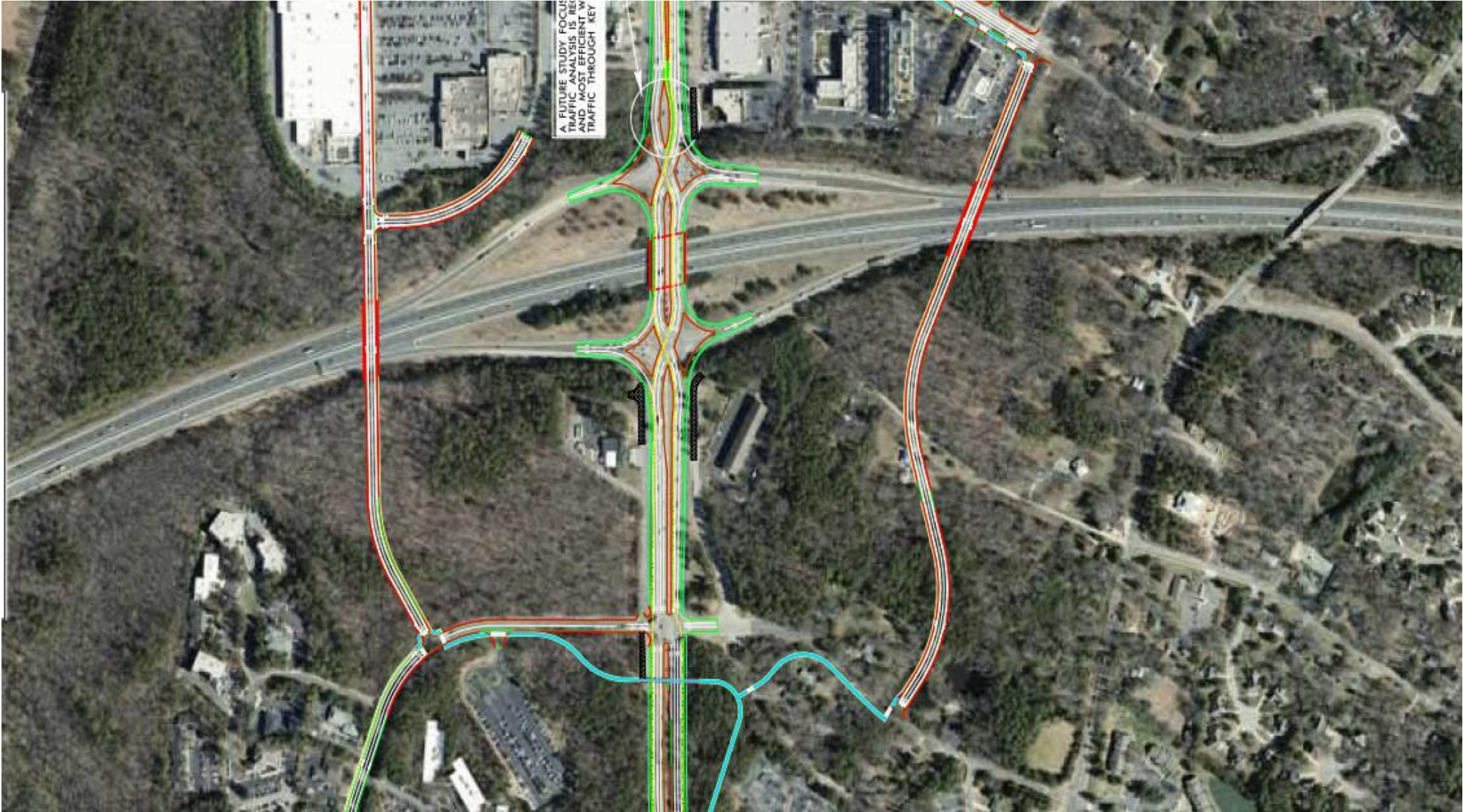



---

## Revised Proposed Eastowne Development – Use, Size, & Timeline

Primary Use:	Health care and associated functions, research, and site-specific retail
Size:	~1.1M sq. ft. net new (excluding ET1)
Number of buildings:	6 (plus 3-4 structured parking) (excluding ET1)
Development Timeline:	1 building every 3-5 years Full build out 25+ years Medical Office Building 2 - ASAP

# Key Points for Today

- The Importance of Eastowne
- Summary of Work to Date
- Review Updated Concept (Bubble) Plan
- Review of Masterplan
- Discuss Community Benefits Options
- Questions





# Eastowne Development – Why?

---

- Provide affordable and accessible health care
- Better patient experience
- Keep it local – within the Chapel Hill community
- Move and decompress outpatient services from the Medical Center
- Increase bed capacity and throughput at the Medical Center

# Healthcare Was Changing Prior to the Pandemic

Personalization

Convenience

Affordability

Transparency



# The Pandemic Accelerated that Change and Spurred More

## How COVID Has Impacted Chronic Disease

Aside from its own direct and terrible death toll, the COVID-19 pandemic is intertwined with the trajectories of other dangerous health conditions – and the consequences are still playing out.

By [Steven Ross Johnson](#) | March 10, 2022, at 4:38 p.m.



## The Impact of COVID-19 on Cancer Screening: Challenges and Opportunities

Ramon S Cancino <sup>1, 2</sup> ; Zhaohui Su <sup>2</sup> ; Ruben Mesa <sup>2, 3</sup> ;  
Gail E Tomlinson <sup>2, 4</sup> ; Jing Wang <sup>2, 5</sup>

Published on 29.10.2020 in Vol 6, No 2 (2020): Jul-Dec



JMIR Cancer  
Patient-Centered Innovations, Education and Technology for Cancer

## COVID-19 pandemic triggers 25% increase in prevalence of anxiety and depression worldwide

2 March 2022 News release | Reading time: 3 min (927 words)



## Prepare for Shifts in Alternative Care Settings

2022 Environmental Scan



American Hospital Association

## Pandemic-Driven Health Policies To Address Social Needs And Health Equity

MARCH 10, 2022

[William K. Bleaser](#), [Humphrey Shen](#), [Hannah L. Crook](#), [Andrea Thoumi](#),  
[Rushina Cholera](#), [Jay Pearson](#), [Rebecca G. Whitaker](#), [Robert S. Saunders](#)

HealthAffairs

## How COVID-19 has changed the way US consumers think about healthcare

June 4, 2021 | Article

by [Jenny Cordina](#), [Eric Levin](#), [Andrew Ramish](#), and [Nikhil Seshan](#)

McKinsey&Company

# Our Patients' & Community's Expectations Have Evolved

---

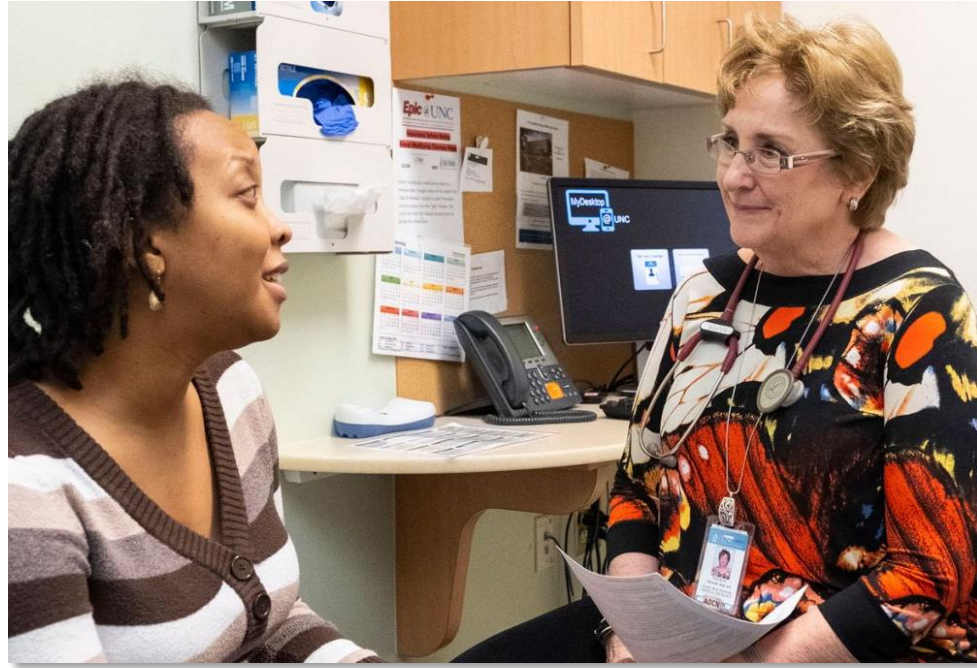

*Easy, affordable access is a must for our patients & community*

**UNC Health must respond to the changing needs  
and expectations of those we serve**

---

# Original Proposed Eastowne Development – Use, Size, & Timeline

Primary Use: Health care and associated functions, research, and site specific retail

Size: ~1.6M sq. ft. - ~1.8M sq. ft.

Number of buildings: ~8 (plus structured parking)

Development Timeline: 1 building every 3-5 years  
Full build out 25+ years  
Medical Office Building 2 - ASAP

# Recent Progress

---



Many productive meetings between Planning Staff and UNC Health team



Conducted Traffic Impact Analysis that shows if we build more than 1.1M net new sq. ft. major road improvements at 15-501 and I-40 would be required



Continue to refine campus layout options for Eastowne campus

Continued discussion regarding affordable housing

# Submitted Concept Site Plan

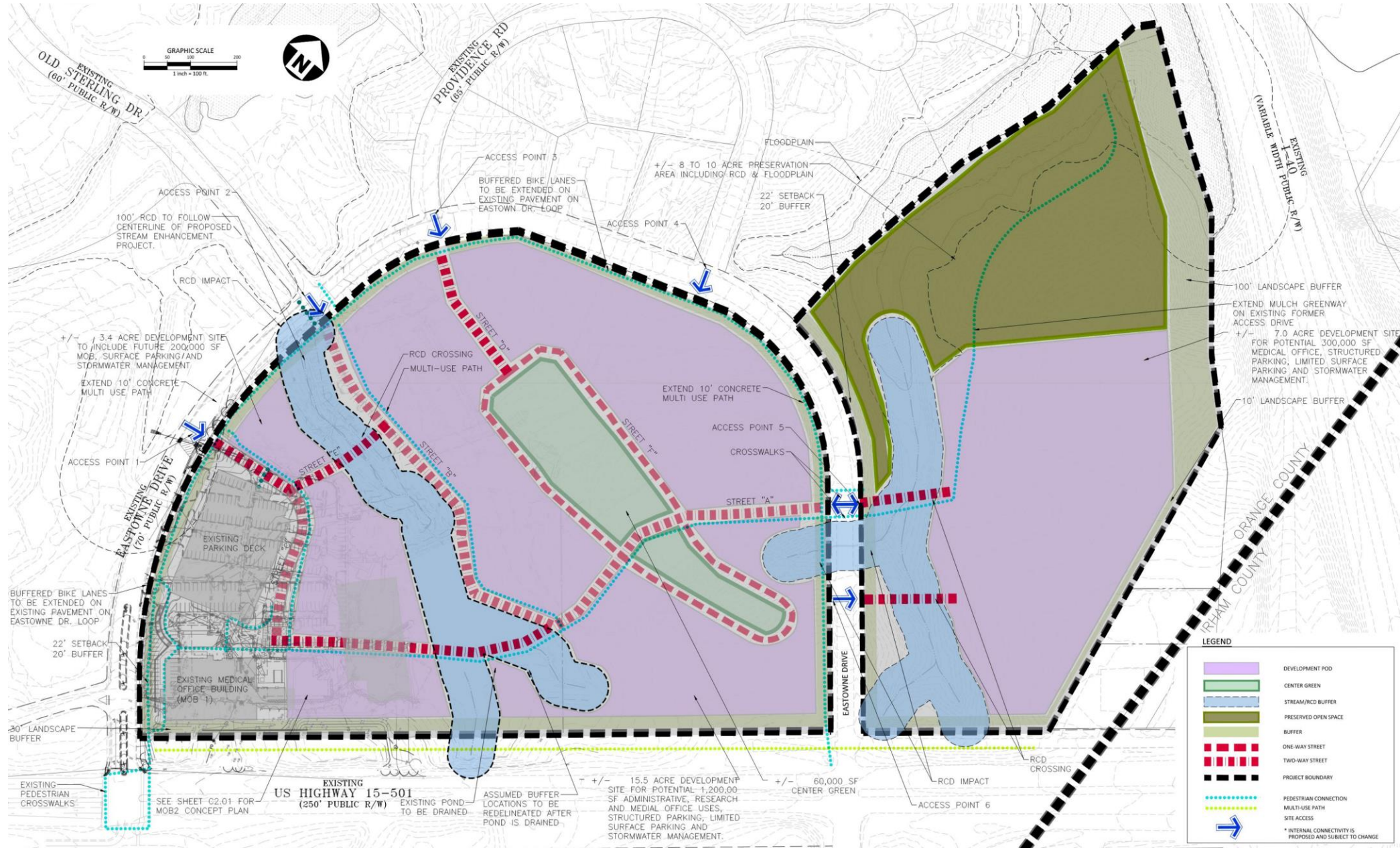

# Revised Concept Site Plan

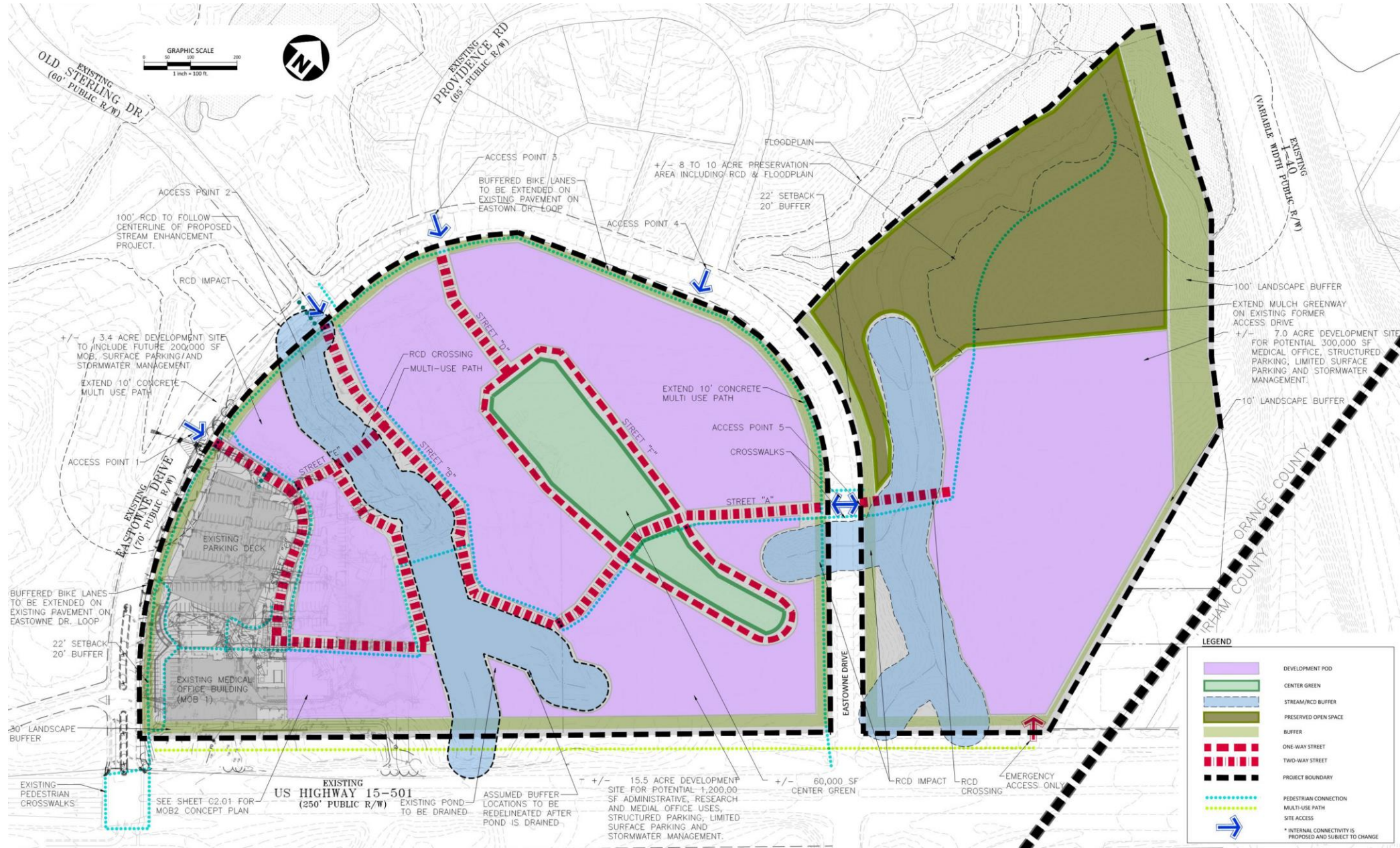





# Eastowne Development at Phase 2

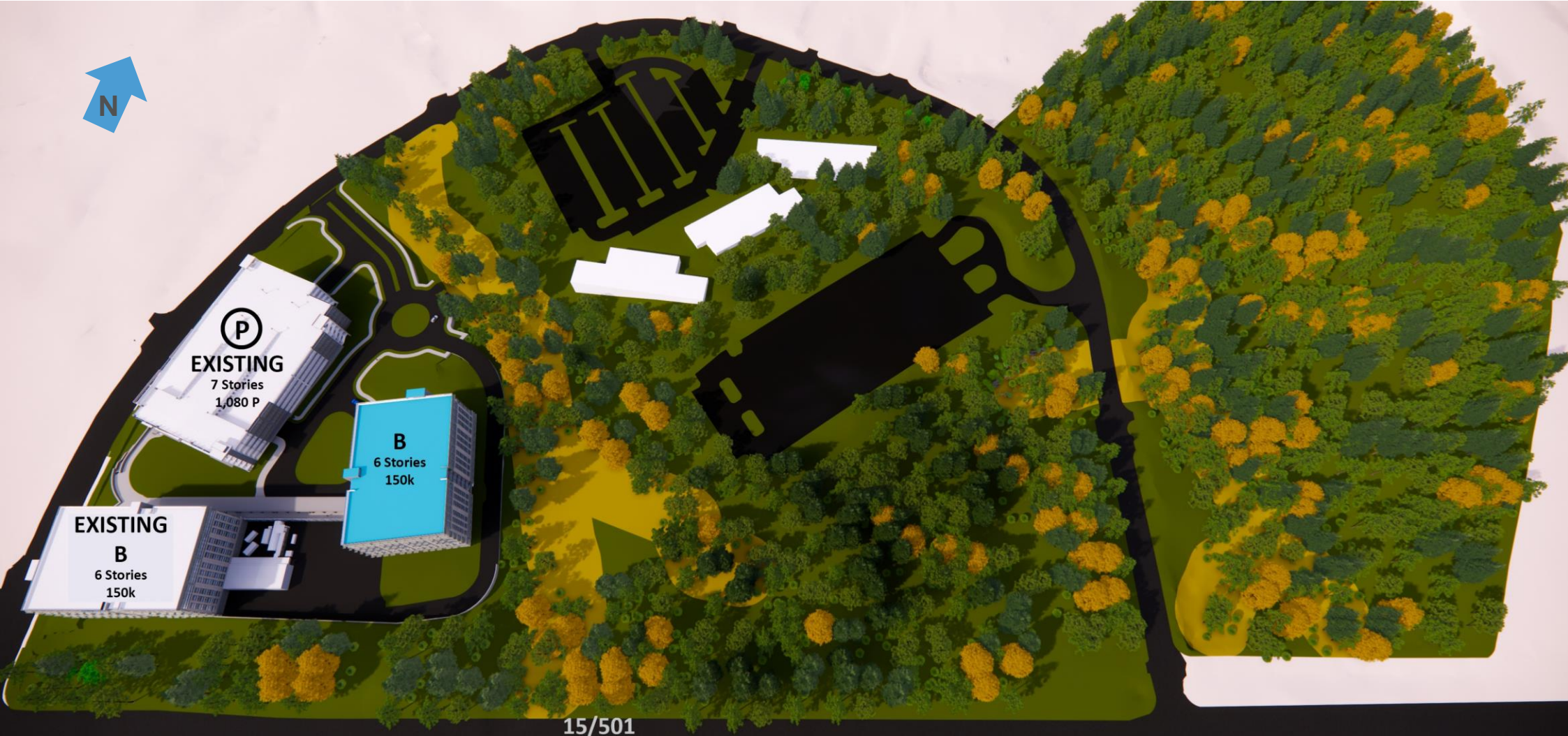

# Eastowne Development at Full Build Out



# Eastowne Development at Full Build Out with Parking on N20 (if required)



# View from Parkline/ 15-501



We are using this rendering to express massing and general circulation only and DOES NOT illustrate intended building or site design. ALL existing and or negotiated standards for planting and pedestrian paths will be followed.

# East Entrance to center green with six story parking decks

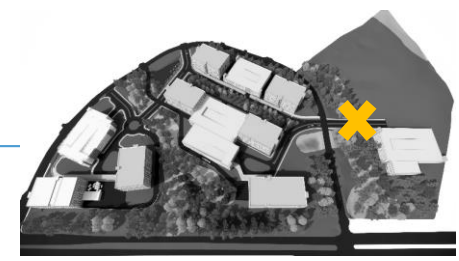

\* We are using this rendering to express massing and general circulation only and DOES NOT illustrate intended building or site design. ALL existing and or negotiated standards for planting and pedestrian paths will be followed.

# East Entrance to center green with six story parking decks



\* We are using this rendering to express massing and general circulation only and DOES NOT illustrate intended building or site design. ALL existing and or negotiated standards for planting and pedestrian paths will be followed.

# West Entrance to center green with six story parking decks



\* We are using this rendering to express massing and general circulation only and DOES NOT illustrate intended building or site design. ALL existing and or negotiated standards for planting and pedestrian paths will be followed.



# View from existing parking deck with MOB II on the right

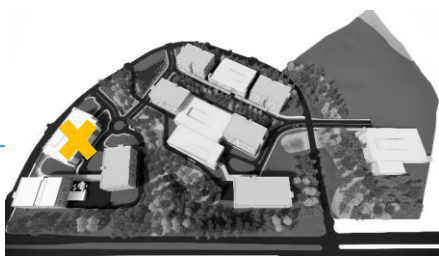

\* We are using this rendering to express massing and general circulation only and DOES NOT illustrate intended building or site design. ALL existing and or negotiated standards for planting and pedestrian paths will be followed.

# View from MOB I with MOB II (and walkway) on the right



\* We are using this rendering to express massing and general circulation only and DOES NOT illustrate intended building or site design. ALL existing and or negotiated standards for planting and pedestrian paths will be followed.

# Connectivity Through and Around the Site



All pedestrian path locations are shown for conceptual progress only and are subject to change

# Complete Community Diagram

## Parkline East Village

Potential Wider Development Framework Diagram



- ..... Area Extent of 4 Current Development Projects
- Pedestrian Connection-Primary
- Pedestrian Connection-Secondary
- Multi-use Trail
- Courtyard, Park, Greenway, Stormwater, RCD
- "The Hub" Community Gathering Space
- Build-to Edge
- Bus Stop-current



03-15-23 update

The Development Framework is envisioned as a general indicator for placement and connectivity, keeping in mind the need for a degree of flexibility in final outcomes. The exact arrangement of buildings, streets, and open spaces will be determined as projects move forward, and more detailed architectural and engineering design is accomplished

# Complete Community Framework Diagram



# Traffic Sensitivity Study

- Traffic mitigation requirements were studied for 6 development densities.
- Significant coordination with Town Staff, HNTB and UNC Health Team to determine appropriate study points and methodology
- UNC Health rightsized the Eastowne development based on practical road network improvements and patient needs.
- To avoid heavy modification to I-40/15-501 interchange, 1.1MSF was selected for max density.

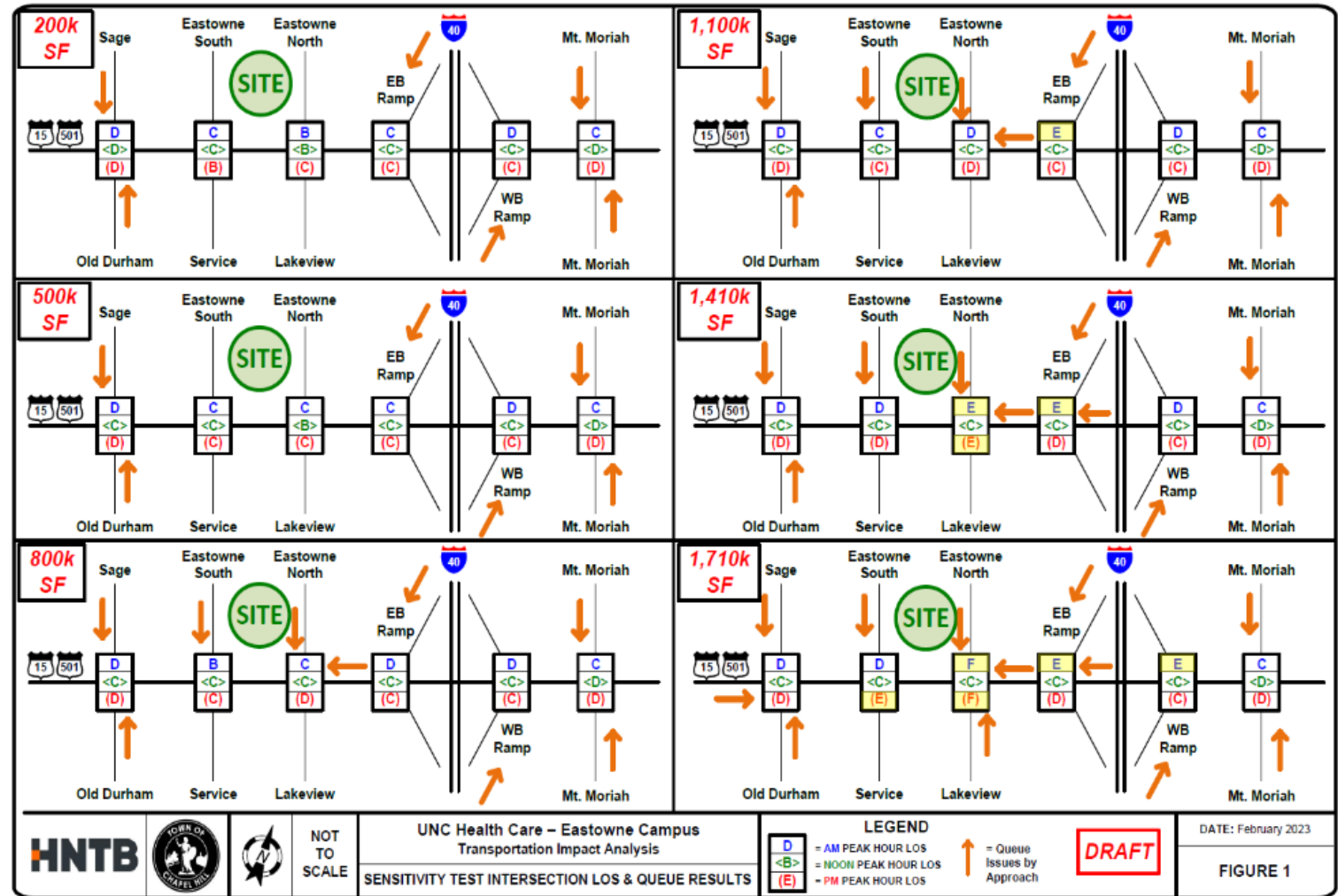

# Traffic Impact Analysis

---

Our original plan was to develop up to 1.7 million square feet of medical office, research and support services during the next 20-25 years

At the beginning of 2023, an incremental sensitivity analysis, to understand what thresholds of development on the Eastowne site would begin to stress the adjacent roadways

Based on the sensitivity analysis of the adjacent roadways, 1.7 million square feet of development would stress the system to a point of requiring roadway improvements beyond UNC Health's ability to mitigate, specifically modifications to the I-40 / 15-501 interchange

Therefore, the proposed development at Eastowne should be held to 1.1 million square feet net new (1.25M sq. ft with ET 1) to limit the traffic improvements that would be triggered by a larger development

# Current Timeline

---

- April 18** Planning Commission
- April 26** Open Public Hearing
- May 24** Town Council Vote on Conditional Zoning for Eastowne



# Complete Community Framework

Assets	
Mature Tree Canopy	<p>Preservation of a minimum of 10-acres of mature tree canopy on the northern 20</p> <p>Preservation of tree canopy at the corner of Eastowne Drive &amp; 15-501 and along the 15-501 frontage</p>
Natural landscapes, waterways, features	<p>1,000 foot stream restoration from 15-501 to Eastowne Drive inside the loop</p> <p>Limited crossings of streams / RCD</p> <p>Preservation of a minimum of 10-acres of mature tree canopy on the northern 20</p>
Opportunity to add density & create critical mass	<p>Redevelopment of an aged, low density, sub-urban office park into a high density medical/ research campus</p>
UNC Presence	<p>Allowing the growth and improvement of services by UNCH within the Town</p>
Willingness to Innovate	<p>This conditional zoning is designed to be a innovative sustainable development integrated into the complete community it will be a part of, day one. It is also flexible to adapt to the changes in the community over time.</p>

# Complete Community Framework

## Design Attributes

### Friendly to Children and Seniors

- Structured visitor parking adjacent to all buildings
- One way traffic for all building drop offs
- Minimize pedestrian and vehicular crossings
- All efforts will be made to insure as much of this site as possible is meet the requirements for ADA accessibility

### Mitigate climate risks: Green infrastructure

- Stormwater management exceeding the Town's requirements
- Green stormwater infrastructure treating a minimum of 1-acre of impervious area

### Walkable

- Closely spaced buildings to parking structures
- Multi-Use Paths are designed to surround the perimeter of the development and connect to the planned multi-use paths by the town outside the scope of this development
- Multiuse paths such that they are inviting and connective

### Human scale

- All buildings will have canopies connecting each building to the parking structure that serve it, at a minimum. This canopy will also be sized to ensure the passenger side of vehicles in all drop off lanes are covered, at a minimum
- The ground floor of each building will be inviting and articulated to reinforce the pedestrian scale
- Site furniture and landscaping will be used to reinforce this experience
- No building will have an unbroken façade for more than 250 feet. If a Building façade exceeds 250 feet a recess in the building façade will be provided at a minimum of 10 feet wide and 10 feet deep

# Complete Community Framework

## Design Attributes

### Identifiable & Distinct

The outer most corner of each building on the central green will be glazed to erode the building's higher elevations

All four side of each building will be designed with similar materials, percentage of glazing and design Building designs provide a depth and layering in the facades to minimize flatness in material expressions

The building elements and features organically express the building's function

Façades use fenestration and design features to appear largely open and transparent

### Everywhere to everywhere greenways

Completing the multi-use path around the Eastowne Drive loop

Completing the section of the multi-use path along the 15-501 frontage

Negotiating pedestrian crossing options for pedestrians to safely cross 15-501

### Watersheds as pedestrian and cycling options

Pedestrian trail along the restored stream inside the Eastowne Drive loop

## Program & Amenities

### Research & Development

UNCH is excited to be a part of this complete community and looks forward to supporting the residential and commercial components existing currently and planned for the future

R&D is an anticipated part of this campus as it grows.

# Complete Community Framework

**Social Equity Drivers**

Active transportation options

- Coordinating & constructing new bus stop locations with Chapel Hill Transit
- Completing bike lanes around the Eastowne Drive loop
- Commitment to support future BRT station on 15-501
- Providing bicycle parking and bicycle fix-it stations

Access to parks and green space

- Internal central green
- Stream restoration project is adjacent pedestrian trail
- Commitment for easement for pedestrian connections to Dry Creek Trail and New Hope Commons Drive when needed

New affordable housing models

- UNCH providing no-cost line of credit

Access to homeownership for historically marginalized communities

- UNCH providing no-cost line of credit

Live/work neighborhoods

- Eastowne provides the work for existing and future adjacent residential developments

# Findings of Fact

---

**Finding #1:** Proposed zoning amendment is necessary to correct a manifest error.

- No manifest error in the Town's Zoning Atlas is being corrected by the requested action.=

**Finding #2:** The proposed zoning amendment is necessary because of a changed or changing conditions in a particular are or in the jurisdiction generally.

- Growth in the healthcare needs for the Town of Chapel Hill and the entire region require the decompression of the medical center by relocating outpatient services.
- The growth of UNC Health and need to provide regional access to healthcare, without entering the center of Chapel Hill is a changed condition due access challenges created by the increased development density within the Town.

**Finding #3:** The proposed zoning amendment is necessary to achieve the purposes of the comprehensive plan.

- Facilitates the development as designated on the Future Land Use Map – North 15-501 Corridor Focus Area for higher intensity uses.
- Supports the Chapel Hill 2020 Plan including *A Place for Everyone, Community Prosperity & Engagement, Getting Around, Good Places-New Spaces, and Nurturing our Community.*
- Rezoning will promote public health, safety and general welfare, and is in conformance with the comprehensive plan.