

**UNC HEALTHCARE  
EASTOWNE MEDICAL OFFICE BUILDING #2**

**DRAFT TRANSPORTATION IMPACT ANALYSIS**

**EXECUTIVE SUMMARY**



**Prepared for:**

The Town of Chapel Hill  
Public Works Department - Engineering

**Prepared by:**

***HNTB North Carolina, PC***

*343 East Six Forks Road  
Suite 200  
Raleigh, NC 27609*

*NCBELS License #: C-1554*

February 2023



**UNC HEALTHCARE  
EASTOWNE MEDICAL OFFICE BUILDING #2**

**DRAFT** TRANSPORTATION IMPACT ANALYSIS

**EXECUTIVE SUMMARY**



**Prepared for:**

The Town of Chapel Hill  
Public Works Department – Traffic Engineering

**Prepared by:**

***HNTB North Carolina, PC***

*343 East Six Forks Road  
Suite 200  
Raleigh, NC 27609*

*NCBELS License #: C-1554*

February 2023



## EXECUTIVE SUMMARY

### **Project Overview**

This study analyzes the continued redevelopment of the existing UNC Health Care property in Chapel Hill, located along US 15-501 (Durham-Chapel Hill Road) and Eastowne Drive, with a second medical-office clinic facility proposed for the site. The project proposes to demolish one existing building with a total size of 24,610 square feet and construct a new building, known as Medical-Office Building #2 (MOB #2) on the existing parcel with an approximate 200,000 square foot size. **Figure ES-1** shows the general location of the site. The project is anticipated to be fully complete by late 2025. This report analyzes the transportation impacts for the build-out scenario for the year 2026 (one year after anticipated completion), the no-build scenario for the 2026 analysis year, as well as 2022 base year traffic conditions.

The proposed site concept plans show several internal transportation network changes from existing conditions, including a relocated access point along Eastowne Drive to serve the new building which will utilize the current structured parking deck that serves MOB #1. The plan also proposes closure of an existing driveway serving existing surface parking lot facilities for the office building to be demolished. **Figure ES-2** displays the preliminary concept plan of the UNC Healthcare Eastowne MOB#2 development, transportation network changes, and nearby land uses and roadways. This report analyzes and presents the transportation impacts that the UNC Healthcare Eastowne MOB#2 redevelopment will have on the following existing and future intersections in the project study area:

- US 15-501 and Sage Road / Old Durham Road
- US 15-501 and Eastowne Drive (South) / Service Road
- US 15-501 and Eastowne Drive (North) / Lakeview Drive
- Eastowne Drive and Old Sterling Drive / UNC Health Care Building 500 Driveway
- Eastowne Drive and Existing UNC Health Care MOB Parking Deck Driveway Access
- Eastowne Drive and Pinegate Circle
- Eastowne Drive and Dobbins Drive

The impacts of the proposed site at the study area intersections were evaluated during the AM, noon, and PM peak hours of an average weekday.

### **Existing Conditions**

#### **Study Area**

The site is located in northeast Chapel Hill along US 15-501 in the Eastowne Business Park. The study area contains three signalized intersections along US 15-501 at Sage Road, Eastowne Drive/Service Road and Eastowne Drive/Lakeview Drive. All future site traffic is expected use a proposed full access site driveway along Eastowne Drive that will be relocated from its current locations. Internal driveways shown on the preliminary site plan will circulate site traffic to structured parking and a patient drop-off/pick-up location. US 15-501 is a major arterial facility providing connectivity between Chapel Hill, Durham and the I-40 corridor. Remaining study area network roadways are either minor arterial/collector facilities or local neighborhood access streets.

#### **Site Traffic Generation**

With the addition of new peak hour trips during the weekday AM, noon, and PM peak hours, there are potential site traffic impacts to the study area intersections. **Table ES-1** shows the site trip generation details, with generation rates taken from existing traffic count data at the MOB#1 Parking Deck Access Driveway and comparative growth ratios calculated from square footage proposed for MOB #2



compared to MOB #1 building square footage. Data was also compared to information from the Institute of Transportation Engineers (ITE) *Trip Generation Manual, Version 11*. Trips for the existing UNC Health Care Building 500 to demolished as part of the site redevelopment were also generated to estimate “full occupancy” for this entitlement and then removed from the Build Scenario traffic volumes.

**Table ES-1. Weekday Vehicle Trip Generation Summary**

Description	Density	Daily			AM Peak			Noon Peak			PM Peak		
		Enter	Exit	Total	Enter	Exit	Total	Enter	Exit	Total	Enter	Exit	Total
MOB #2	200k SF	1,999	1,999	3,998	363	68	431	220	195	414	33	329	362
<b>Adjustments</b>													
Transit Reduction	5%	-100	-100	-200	-18	-3	-22	-11	-10	-21	-2	-16	-18
Ped/Bike/Internal Reduction	5%	-100	-100	-200	-18	-3	-22	-11	-10	-21	-2	-16	-18
<b>Total Net Vehicle Trips Added to Network</b>		<b>1,799</b>	<b>1,799</b>	<b>3,598</b>	<b>327</b>	<b>62</b>	<b>387</b>	<b>198</b>	<b>175</b>	<b>372</b>	<b>29</b>	<b>297</b>	<b>326</b>

**Background Traffic**

Background traffic growth for the 2026 analysis year is expected to come from two sources - ambient regional traffic growth and specific development-related traffic growth. Three developments near the project study area that are currently in the Town planning review process are expected to contribute to specific background traffic generator growth. All remaining estimated traffic volume increases are assumed to occur due to overall region-wide ambient growth (assumed 2.5 percent per year based on NCDOT/Town provided historic growth data and data related to peak hour traffic conditions rebounding from the effects of COVID-19). Additional background traffic adjustments were made for the demolition of the existing UNC Health Care Building 500 currently located on the site.

**Impact Analysis**

**Peak Hour Intersection Level of Service**

Existing traffic operations at all study area intersections are acceptable during all three peak hours analyzed, though the intersection of US 15-501 and Sage Road/Old Durham Road is congested and nearing capacity during peak travel periods. The projected ambient and background development traffic growth will increase intersection delay and queue impacts by 2026. With the addition of peak hour site-generated “net” trips to the projected 2026 background traffic volumes, no study area intersections are expected to experience deficient traffic operations in any peak hour. Proposed geometric and signal timing improvements are expected to mitigate anticipated deficient LOS conditions throughout the study area and improve queue storage and safety, as well.

A summary of the traffic operations for each intersection, related to vehicular delays (intersection average as a whole if signalized, critical movement if stop-controlled) and the corresponding traffic microsimulation Level-of-Service (LOS<sub>s</sub>) is shown in **Table ES-2**.

**Access Analysis**

Vehicular site access is to be accommodated by the proposed relocated full movement access driveway connecting to Eastowne Drive for entry/exit to the existing structured parking and on-site surface drop-off areas. Design details related to driveway throat lengths shown on the site plan and driveway spacing from existing intersections and adjacent driveways adhere to NCDOT *Policy on Street and Driveway Access to North Carolina Highways* and the Town of Chapel Hill Design Manual.



**Table ES-2. Peak Hour Intersection Capacity Analysis Summary**

Intersections	Peak Hour	2022 Existing		2026 No-Build		2026 Build		2026 Mitigated	
		LOS <sub>s</sub>	Delay	LOS <sub>s</sub>	Delay	LOS <sub>s</sub>	Delay	LOS <sub>s</sub>	Delay
US 15-501 and Sage Road / Scarlett Drive	AM	D	36.5	D	45.2	D	48.1	D	39.9
	NOON	C	31.7	C	32.9	D	41.1	C	33.1
	PM	C	34.0	D	40.6	D	42.5	D	40.7
US 15-501 and Eastowne Drive (South) / Service Road	AM	B	16.7	C	20.4	D	40.5	C	20.9
	NOON	B	16.5	B	17.1	C	23.3	C	22.3
	PM	B	14.9	B	14.6	C	20.5	C	21.6
US 15-501 and Eastowne Drive (North) / Lakeview Drive	AM	B	12.2	B	17.7	B	19.4	B	15.5
	NOON	B	10.3	B	13.2	B	16.6	B	14.8
	PM	B	13.2	B	16.5	B	17.3	C	23.2
Eastowne Drive and Old Sterling Drive / UNC Health Care Building #5 Driveway <sup>#</sup>	AM	A	5.7	A	5.9	A	6.3	A	6.2
	NOON	A	5.7	A	6.0	A	6.4	A	6.5
	PM	A	6.1	A	6.3	A	6.0	A	5.8
Eastowne Drive and Existing MOB Parking Deck Driveway Access <sup>#</sup>	AM	A	6.1	A	7.2	A	9.0	A	9.7
	NOON	A	6.0	A	6.3	A	8.9	A	8.9
	PM	A	5.6	A	5.8	<b>F</b>	<b>100</b>	A	8.6
Eastowne Drive and Pinegate Circle <sup>#</sup>	AM	A	3.8	A	3.9	A	4.8	A	4.4
	NOON	A	3.9	A	4.5	A	5.4	A	5.3
	PM	A	4.0	A	4.1	<b>F</b>	<b>107</b>	A	5.2
Eastowne Drive and Dobbins Drive <sup>#</sup>	AM	A	7.6	A	8.5	B	11.9	B	11.7
	NOON	B	13.0	B	13.3	C	23.4	C	22.2
	PM	C	22.6	D	32.1	<b>F</b>	<b>355</b>	D	31.8

**BOLD/ITALICS** – Critical Movement or Overall Intersection Requires Mitigation Per Town TIA Guidelines

# - Worst-Case LOS/Delay for Unsignalized/Stop-Controlled Critical Movement

Access for pedestrians and bicyclists is subject to some limited connectivity in the project study area. Sidewalk is present on most study area facilities and connections along US 15-501 in the vicinity of Wegmans exist, along with signalized crossings of US 15-501 at Eastowne Drive adjacent to the site and at Sage Road/Old Durham Road. Connectivity is impaired due to lack of continuous sidewalk along other sections of US 15-501. Bicycle lanes exist on Sage Road, Old Sterling Drive, and a short section of Eastowne Drive immediately adjacent to the site, with the remaining cross-section width of Eastowne Drive not inhibiting bicycling, but there is no bicycling connectivity on the US 15-501 corridor.

### Signal Warrant Analysis

Based on projected 2026 traffic volumes and proposed access plans, no unsignalized intersection in the project study area would warrant the installation of a traffic signal, based on the methodology found in the *2009 Manual on Uniform Traffic Control Devices (MUTCD)*.

### Crash Analysis

Data from the NCDOT Traffic Safety Unit was provided for the five-year period 12/1/2017 to 11/30/2022 for the US 15-501 and Eastowne Drive segments in the vicinity of the proposed site. There were 396 crashes reported along the US 15-501 study area corridor between Sage Road and Eastowne



Drive/Lakeview Drive over the five year period, with 26 crashes on Eastowne Drive. The primary crash type was rear end crashes and crashes were primarily clustered near the three signalized intersections. Overall, the number and severity of crashes along US 15-501 in the project study area are higher than state-wide averages for similar urban US highway and secondary roadway facilities.

**Other Transportation-Related Analyses**

Other transportation-related analyses relevant to the 2001 Town of Chapel Hill Guidelines for the preparation of Traffic Impact Studies were completed as appropriate. The following topics listed in **Table ES-3** are germane to the scope of this study.

**Table ES-3. Other Transportation-Related Analyses**

Analysis	Comment
Turn Lane Storage Requirements	Storage bay lengths at study area intersections were analyzed using TransModeler maximum queue length estimates for the 2026 Build Scenario. No unsignalized intersection is expected to have excessive peak hour queues or conditions that exceed existing turn lane storage. Recommendations to improve turn lane storage were made for the US 15-501 and Eastowne Drive/Service Road intersection – as this location will have the highest degree of site traffic impact. Storage issues not due to site-related traffic impacts are not easily correctable at other upstream/downstream intersections, given the high traffic volumes along the US 15-501 corridor, but adjustments to signal timing are shown to potentially reduce side street queues at critical locations.
Appropriateness of Acceleration/Deceleration Lanes	The site concept plan shows no specifics related to acceleration/deceleration lanes. Due to the low speed limit on Eastowne Drive (25 mph) and the presence of some on-street parking in the vicinity, no acceleration/deceleration lanes are recommended for site access. Existing intersections along US 15-501 currently have left-turn and right-turn auxiliary deceleration lanes. No other specific acceleration/deceleration lane issues were analyzed in the project study area.
Pedestrian and Bicycle Analysis	Pedestrian access exists in the project study area but connectivity is limited directly along the US 15-501 corridor. Bicycle lanes extend along Sage Road, Old Sterling Drive, Old Durham Road, and a short section of Eastowne Drive that was included in the MOB #1 project. Very limited bicycle facilities exist along/parallel to the US 15-501 corridor within the project study area. The site plan shows additional sidewalk developed along site frontage. Additional pedestrian and bicycle facilities should be provided along Eastowne Drive to connect the site to the Old Sterling Drive intersection.
Public Transportation Analysis	Public transportation service to the study area, and to the proposed site is adequate, with bus stops and multiple local and regional bus routes on both Eastowne Drive and US 15-501 proximate to the site.

**Mitigation Measures/Recommendations**

**Planned Improvements**

There are no Town of Chapel Hill / North Carolina Department of Transportation improvement projects affecting study area roadway facilities within the analysis year time frame of 2022-2026. NCDOT STIP project EB-4707B has completed construction along Old Durham Road/Old Chapel Hill Road east of the project study area and included pedestrian and bicycle improvements connecting to the US 15-501 corridor at the Sage Road/Scarlett Drive intersection. The US 15-501 corridor is currently being studied for capacity improvements as part of NCDOT STIP U-5304F, but these improvements are not known at this time and were not considered to be complete by the 2026 analysis year.

**Background Committed Improvements**

There are currently no committed background improvements to the project study area from private development projects expected to be complete by the 2026 analysis year. Several development





projects are currently under study, but their final required transportation improvements are not known at this time.

### **Applicant Committed Improvements**

Based on the preliminary site plans and supporting development information provided, there are several minor specific transportation-related improvements proposed on or along the frontage of the UNC Health Care Eastowne MOB #2 site. These improvements include the following:

- Extension of existing sidewalk along the site frontage past the proposed relocated MOB Parking Deck Access Driveway.
- Provision of the relocated two-way access driveway with internal traffic circle connecting to future internal roadways on the UNC Health Care Eastowne Property. Driveway parking deck lower floor access connection for employee parking to include a right-turn auxiliary lane to remove this traffic from the patient traffic heading into the site.
- Demolition of the 500 Building and closure of its adjacent surface parking lot and connection to Eastowne Drive.



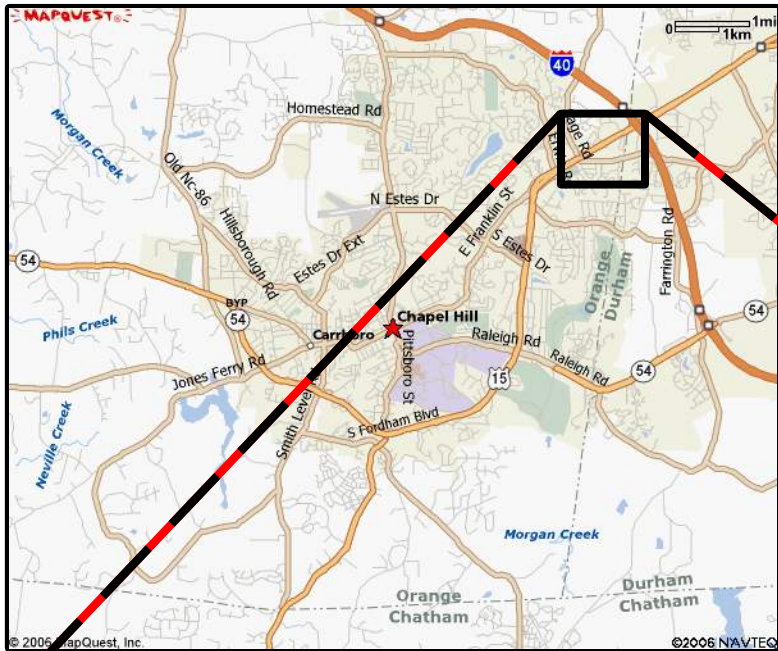

### **Necessary Improvements**

Based on traffic capacity analyses for the 2026 design year, and analyses of existing study area turning bay storage lengths, site access and multi-modal mobility, the following improvements (see **Figure ES-3**) are recommended as being necessary for adequate transportation network operations:

- 1) To manage projected maximum queue lengths on southbound Eastowne Drive at the US 15-501 signalized intersection, it is recommended that the existing left-turn lane be extended from 300 feet to provide 375 feet of vehicle storage. This will reduce the available left-turn storage for the Pinegate Circle intersection, but capacity analysis and queue results indicate that 75 feet of full storage for that movement should be sufficient.
- 2) To extend existing pedestrian and bicycle facilities along Eastowne Drive in the vicinity of the proposed redevelopment, the section of Eastowne Drive between the existing MOB Parking Deck Access Driveway and Old Sterling Drive should have on-street parking eliminated and buffered bicycle lanes and a three-lane vehicular cross-section should be implemented, which may require some widening along the site frontage from the existing parking deck driveway to Old Sterling Drive. Left-turn lanes with 100 feet of storage should be delineated in this vicinity for the relocated Parking Deck Access Driveway and Old Sterling Drive.
- 3) The existing pedestrian sidewalk along Eastowne Drive in front of MOB #1 and the Parking Deck should be extended to Old Sterling Drive and marked crosswalks be provided at this intersection crossing Old Sterling Drive and at the southbound approach along Eastowne Drive.
- 4) The proposed concept plan for the relocated Parking Deck Access Driveway should include the provision of a right-turn auxiliary lane with at least 75 feet of storage at the Eastowne Drive intersection. Noon and PM peak exiting traffic volumes from the parking deck are expected to be high, with a balanced proportion turning in each direction onto Eastowne Drive. Separate egress lanes would provide additional capacity and prevent the egress traffic from queuing to the vicinity of the internal traffic circle near the parking deck.
- 5) Signal timings at all three study area intersections should be reoptimized to account for the effects of site-related traffic. Signal timings for the Eastowne Drive approaches to the two US 15-501 intersections need to account for increase traffic volumes requiring more minor street green time to clear queues in one signal phase.



**LEGEND**

-  = Existing Building Footprint
-  = Existing Study Area Intersection
-  = Proposed Site Driveway
-  = Proposed Site Parcel

DRAFT

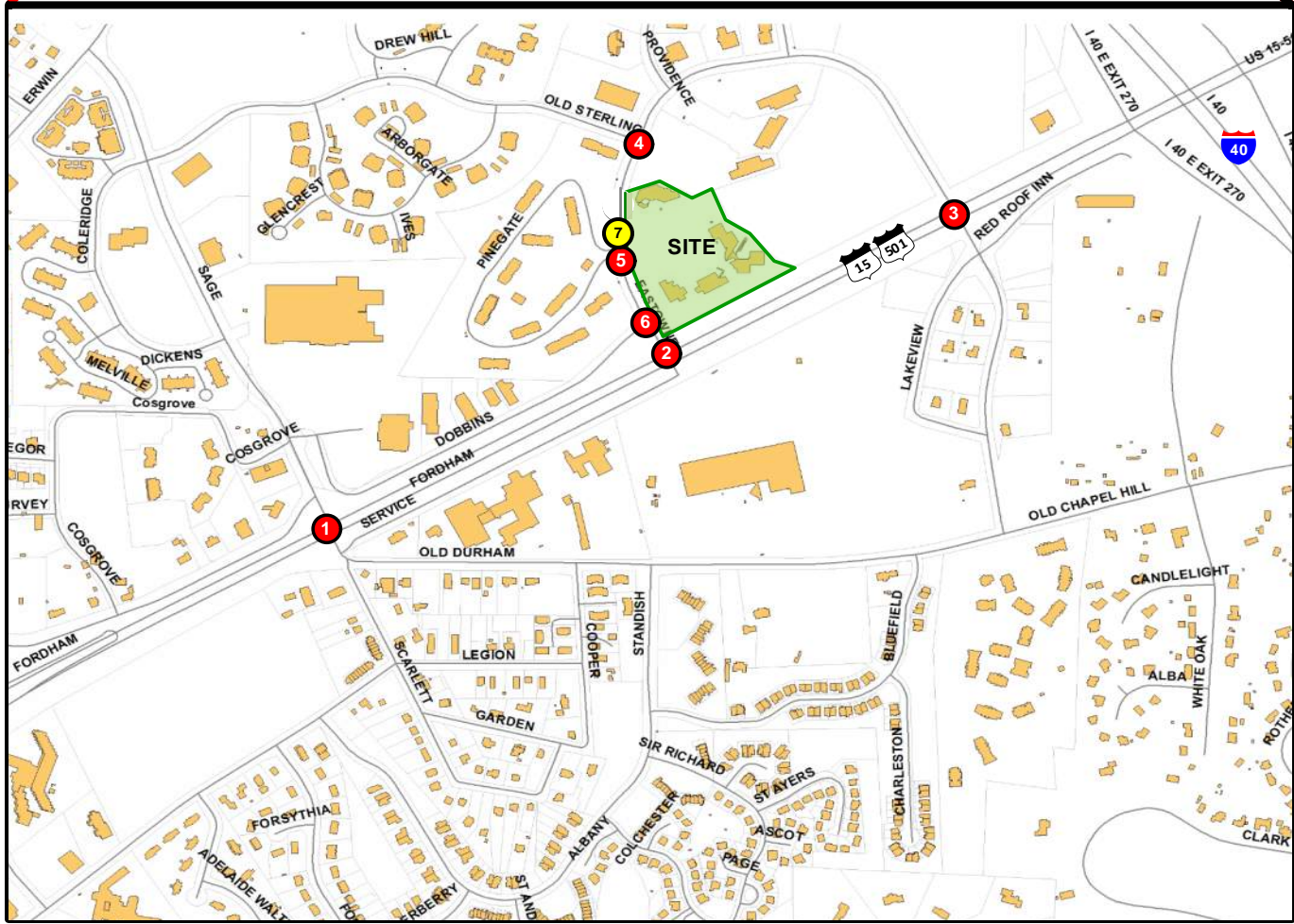

**UNC Health Care Eastowne MOB #2  
Transportation Impact Analysis**

DATE: February 2023

**PROJECT STUDY AREA**

**FIGURE ES-1**



**DRAFT**

NOT TO SCALE

**HNTB**

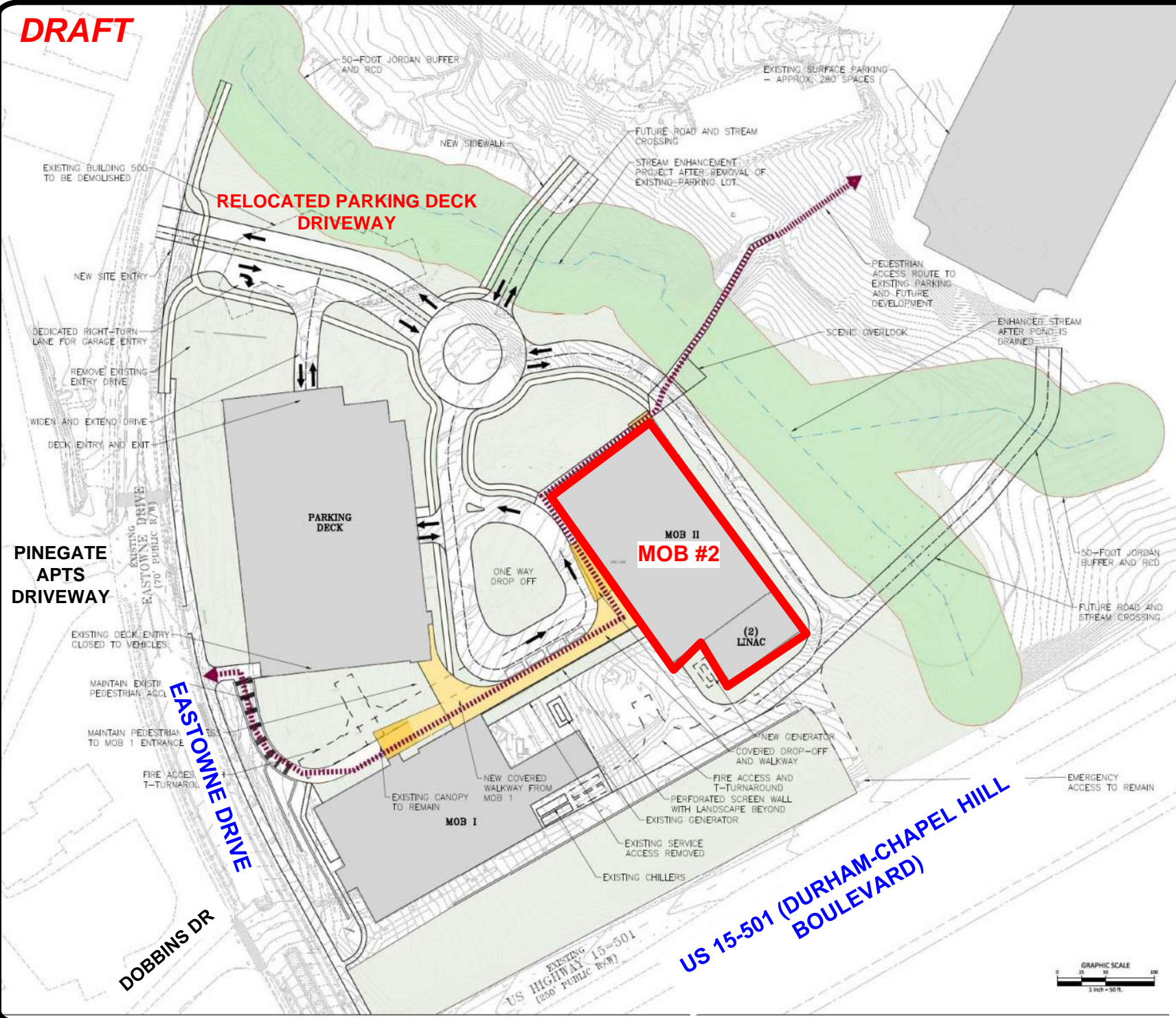

**UNC Health Care Eastowne MOB #2  
Transportation Impact Analysis**

**PRELIMINARY SITE PLAN**

DATE: February 2023

**FIGURE ES-2**



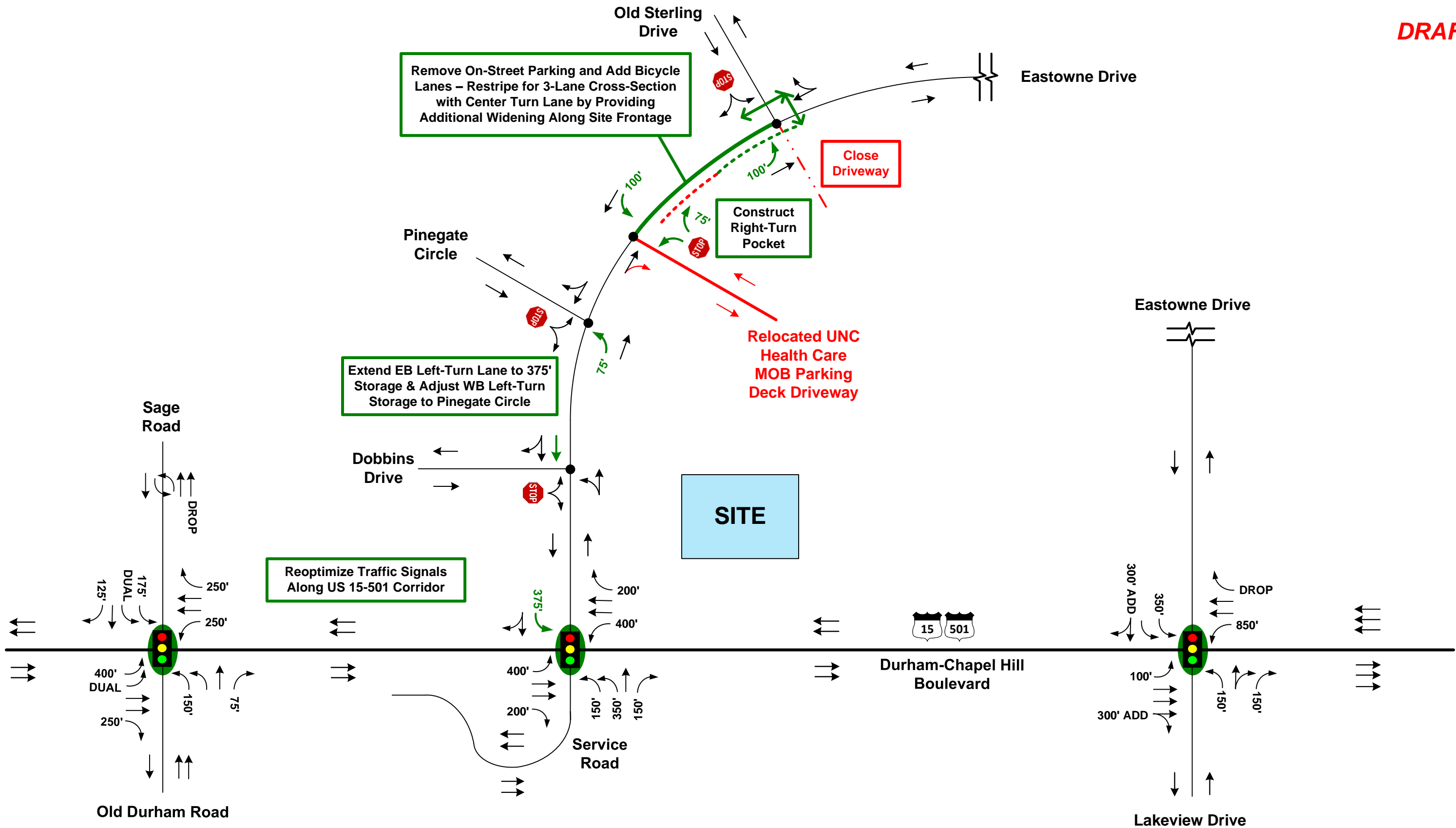

	<p>NOT TO SCALE</p>	<p><b>LEGEND</b></p> <ul style="list-style-type: none"> <li> = COMMITTED IMPROVEMENT</li> <li> = NECESSARY IMPROVEMENT</li> <li> = SIDEWALK</li> <li> = UNSIGNALIZED PED CROSSING</li> </ul>		<p><b>UNC Health Care Eastowne MOB #2</b> Transportation Impact Analysis</p>	<p>DATE: February 2023</p>
		<p><b>COMMITTED AND RECOMMENDED IMPROVEMENTS</b></p>		<p><b>FIGURE ES-3</b></p>	

**TECHNICAL  
MEMORANDUM - DRAFT**



**To**  
Roger Henderson  
Traffic Engineering Manager  
Town of Chapel Hill

**From**  
Craig Scheffler, P.E., PTOE  
HNTB North Carolina, P.C.

**Cc**  
HNTB Project File: 85279

**Subject**  
UNC Health Care Eastowne Campus  
Sensitivity Test Evaluation

**Date**  
02/24/23

HNTB North Carolina, PC (HNTB), per direction from Town of Chapel Hill staff and the Applicant for the UNC Health Care Eastowne Campus redevelopment and as part of the scope of services for the UNC Health Care Eastowne Medical-Office Building #2 (MOB #2) Transportation Impact Analysis (TIA), has completed sensitivity tests related to intersection-level traffic operations along the US 15-501 corridor near the Eastowne site. The sensitivity tests focus on a gradation of increasing development densities on the Eastowne Campus site and their corresponding traffic impact to the US 15-501 corridor. The purpose of the analysis is to generally, and broadly, determine at what points of development density will individual intersections fall below acceptable operational standards and require additional capacity (more turn lanes, through travel lanes) to mitigate the impacts.

**Methodology and Assumptions**

Per a project scoping meeting on December 15, 2022 with Town of Chapel Hill staff, the Applicant, and HNTB, the decision was made to utilize a traffic model in the Synchro 11 software package to evaluate increasing development density impacts on 2022 base year traffic volumes and omit the typical analysis methodology that would also include background traffic growth impacts for future year conditions. This decision was made to attempt to isolate the specific impact of Eastowne Campus development-related traffic on nearby intersections and assess at what level of development density would those intersections require substantial improvements to mitigate the impact. Intersections were analyzed for typical weekday AM, noon, and PM peak hour periods for the following scenarios:

- 2022 Existing Year – 200,000 SF of redevelopment (corresponding to MOB #2)
- 2022 Existing Year – 500,000 SF of redevelopment
- 2022 Existing Year – 800,000 SF of redevelopment
- 2022 Existing Year – 1,100,000 SF of redevelopment
- 2022 Existing Year – 1,410,000 SF of redevelopment (corresponding to the maximum development potential inside the Eastowne Drive loop portion of the property, as provided by the Applicant and studied previously)
- 2022 Existing Year – 1,710,000 SF of redevelopment (corresponding to the 2032 Full Build-Out Scenario previously studied)

The following intersecting streets along US 15-501 were the primary focus of the operational analysis:

- Sage Road/Old Durham Road
- Eastowne Drive/Service Road
- Eastowne Drive/Lakeview Drive
- I-40 Eastbound Ramps
- I-40 Westbound Ramps
- Mt. Moriah Road

Operational analysis output from the model included Level-of-Service (LOS), vehicular delay, and 95<sup>th</sup> percentile queuing results by approach for each study area intersection.

### **Traffic Volume Development**

Traffic volumes used in the models were taken from balanced 2022 base year counts completed for the *UNC Health Care Eastowne Campus Phase 1 - 2032 Full Build-Out Future Scenario Transportation Impact Analysis* (HNTB, December 2022). All build-out development scenario site traffic distribution and assignment estimates were taken from the full 2032 Build-Out traffic assignments completed in the previously submitted documentation and then assigned a ratio of the proposed scenario development yield in square feet divided by the full build-out estimate of 1,710,000 square feet. Each proportioned traffic assignment scenario was added to the 2022 base year volumes for all peak hours and the results were input into the Synchro capacity analysis software for evaluation. All traffic volume calculation spreadsheets are found in *Appendix A*.

### **Scenario Testing Methodology and Assumptions**

Synchro traffic capacity analysis models were taken from previous studies completed for the Town and updated with existing coordinated signal timings and the 2022 peak hour balanced traffic volumes. Models were then modified for the following:

- Applied successive traffic volume changes for each development density scenario
- Updated coordinated traffic signal timings (holding cycle lengths constant and adjusting splits, offsets and phase order changes)

Model data (overall intersection LOS and vehicular delays) and 95<sup>th</sup> percentile queue estimates by movement and approach were extracted from the model. No geometric modifications were made for any model scenario.

### **Model Results and Comment**

Table 1 shows the sensitivity testing results for study area intersections for all six development density scenarios. The table shows AM, noon, and PM peak hour overall intersection LOS and corresponding overall per-vehicle delays. Each intersection may have one or several individual movements or approaches (particularly on the minor side streets) that may operate at worse LOS/delays than the overall values reported. In some cases delays and LOS may actually improve with additional Eastowne development density, due to the assigned traffic volumes benefiting from coordinated traffic movements along US 15-501 or because signal reoptimization calculations for a given set of traffic volumes may progress traffic flows along the entire corridor slightly different for each given intersection.

**Table 1. Scenario Sensitivity Testing - Traffic Operations Results**

US 15-501 Intersection	AM Peak Hour		Noon Peak Hour		PM Peak Hour	
	LOS	Delay Sec/Veh	LOS	Delay Sec/Veh	LOS	Delay Sec/Veh
<b>Sage Road / Old Durham Road</b>						
2022 MOB #2 (200k SF)	D	41.3	D	35.3	D	43.9
2022 500k SF	D	41.3	C	34.8	D	41.3
2022 800k SF	D	39.3	C	34.3	D	40.6
2022 1,100,000 SF	D	38.3	C	34.0	D	40.2
2022 1,410,000 SF	D	40.1	C	34.1	D	39.9
2022 1,710,000 SF	D	40.3	C	34.1	D	39.5
<b>Eastowne Drive South / Service Road</b>						
2022 MOB #2 (200k SF)	C	25.2	C	20.5	B	19.7
2022 500k SF	C	28.6	C	21.8	C	23.9
2022 800k SF	B	19.4	C	24.7	C	27.2
2022 1,100,000 SF	C	25.4	C	28.3	C	31.5
2022 1,410,000 SF	D	38.3	C	29.6	D	42.2
2022 1,710,000 SF	D	48.4	C	31.1	<b>E</b>	<b>62.0</b>
<b>Eastowne Drive North / Lakeview Drive</b>						
2022 MOB #2 (200k SF)	B	18.8	B	14.9	C	22.8
2022 500k SF	C	22.2	B	17.7	C	29.0
2022 800k SF	C	32.2	C	20.9	D	38.6
2022 1,100,000 SF	D	50.9	C	23.7	D	49.0
2022 1,410,000 SF	<b>E</b>	<b>73.5</b>	C	27.2	<b>E</b>	<b>66.6</b>
2022 1,710,000 SF	<b>F</b>	<b>105.1</b>	C	31.4	<b>F</b>	<b>80.3</b>
<b>I-40 Eastbound Ramps</b>						
2022 MOB #2 (200k SF)	C	31.2	C	21.3	C	30.1
2022 500k SF	C	32.6	C	21.7	C	30.6
2022 800k SF	D	42.3	C	21.9	C	31.0
2022 1,100,000 SF	<b>E</b>	<b>55.8</b>	C	23.4	C	33.2
2022 1,410,000 SF	<b>E</b>	<b>66.2</b>	C	25.2	D	35.9
2022 1,710,000 SF	<b>E</b>	<b>68.8</b>	C	28.5	D	46.2
<b>I-40 Westbound Ramps</b>						
2022 MOB #2 (200k SF)	D	42.4	C	26.2	C	26.4
2022 500k SF	D	44.1	C	26.9	C	26.2
2022 800k SF	D	45.8	C	29.6	C	27.8
2022 1,100,000 SF	D	48.2	C	30.1	C	28.7
2022 1,410,000 SF	D	50.7	C	31.5	C	29.5
2022 1,710,000 SF	<b>E</b>	<b>59.7</b>	C	27.6	C	30.7
<b>Mt. Moriah Road</b>						
2022 MOB #2 (200k SF)	C	33.5	D	50.5	D	46.0
2022 500k SF	C	32.9	D	50.5	D	48.0
2022 800k SF	C	34.1	D	49.4	D	48.3
2022 1,100,000 SF	C	32.5	D	49.7	D	48.8
2022 1,410,000 SF	C	32.9	D	49.4	D	49.0
2022 1,710,000 SF	C	33.6	D	51.1	D	49.4



The tabular results indicate that the intersections furthest from the site along US 15-501 – Sage Road/Old Durham Road and Mt. Moriah Road have little variance in delay or LOS results with additional increases in development density. They both are busy intersections with conditions near capacity (LOS D) in at least one peak hour and queue issues at minor street approaches.

The two Eastowne Drive intersections with US 15-501 have the greatest range of impacts, as the majority of all site-related traffic for the Eastowne Campus will use these two intersections for access to the site. Both intersections initially operate well under capacity, with LOS B or LOS C results, but with increasing development densities, they fall to LOS E or F once development densities are in excess of 1,000,000 square feet. To mitigate traffic operations in the vicinity, additional through travel lane capacity and turn lanes may be needed on US 15-501 and side streets serving these intersections.

The I-40 signalized ramp terminal intersections with US 15-501 are likely to facilitate substantial amount of site-related traffic, whether it be regional trips using I-40 or trips using US 15-501 to/from areas in Durham. Below 1,000,000 square feet of development, overall intersection LOS in all peak periods is at least LOS D or better but falls to LOS E in the AM peak hour when 1,100,000 square feet was tested at the I-40 eastbound ramps intersection closest to the site. Additional queue results indicate that there are peak hour queue issues at lower development densities on the off-ramps in each direction approaching US 15-501 – some of which may include queuing back onto the I-40 mainline travel lanes - and at 800,000 square feet of development, queue issues occur for at least one peak hour on US 15-501 southbound between the ramps and Eastowne Drive/Lakeview Drive. Additional development density worsens queues, which start to back up through the interchange.

Overall intersection LOS comparisons and individual intersection approaches with queue issues in at least one peak hour are shown in **Figure 1**. As described above, queue issues are expected to occur at several intersections that feature current queue issues for minor streets in at least one peak hour in 2022. As shown in the figure, though overall intersection LOS does not fall to below LOS D thresholds, queue issues begin to occur at the 800,000 square foot development level for both Eastowne Drive connections to US 15-501 and for US 15-501 southbound just north of the site. Mitigation for queue issues may also be tied to capacity improvements or, at the very least, turn bay storage lengthening.

A final note on this sensitivity analysis study results – since the analysis was limited to increasing traffic volumes from different development densities for the UNC Health Care Eastowne Campus on 2022 base year volumes, no valid comparison can be made from these results to the results presented in the previous TIA of the 2032 Full Eastowne Campus Build-Out Scenario, or any 2026 design year results for the current UNC Health Care Eastowne MOB #2 TIA – as these studies include the effects of projected area-wide and specific local background traffic growth. All future formal TIA analyses for actual redevelopment plans that include the location of buildings and parking facilities will produce different results than what is shown in this sensitivity analysis and will need to include the updated base year traffic volumes at the time the studies are undertaken, as well as inclusion of projected background traffic growth for those studies for each development plan's anticipated build-out year.

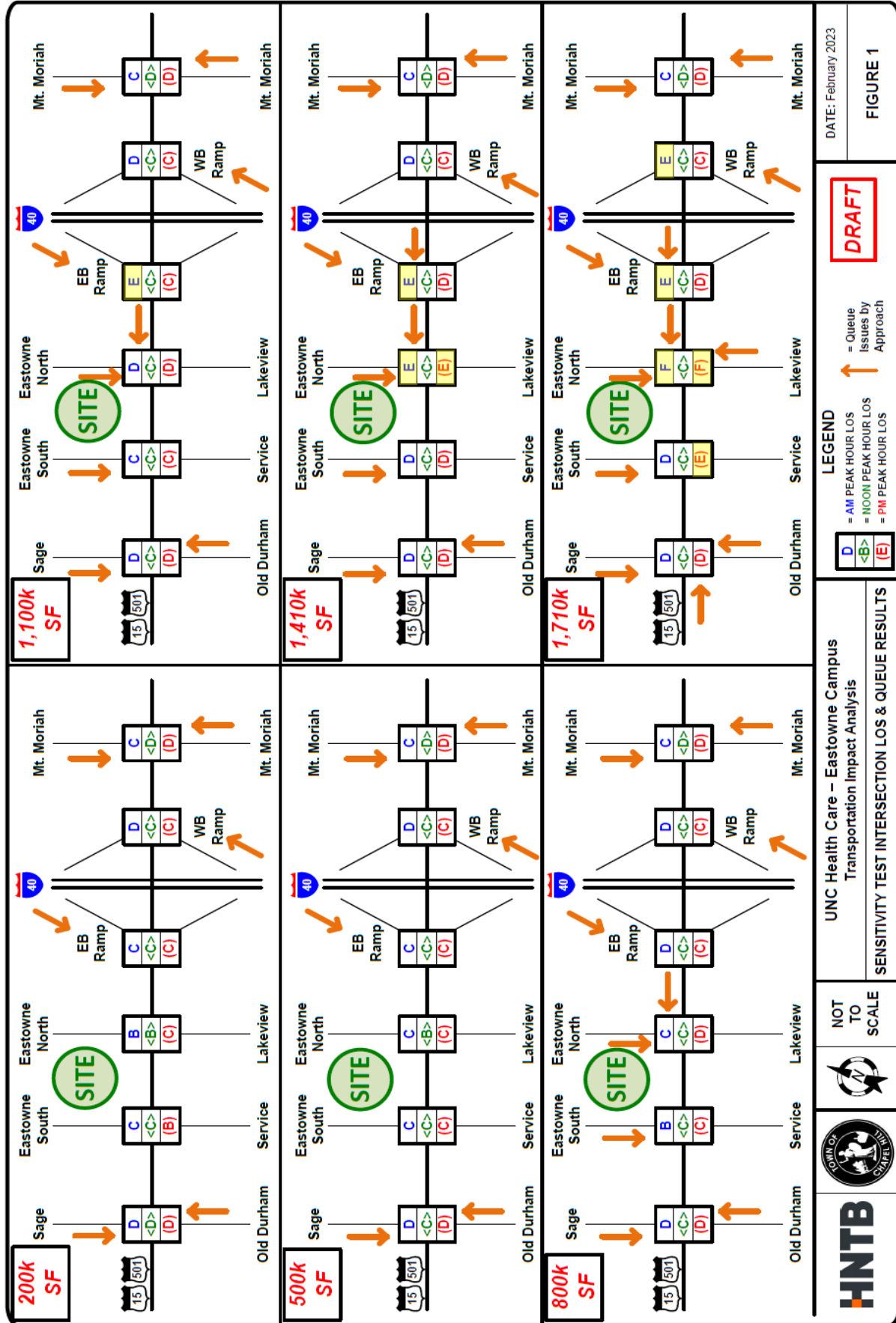

DATE: February 2023

FIGURE 1

**DRAFT**

LEGEND  
 = AM PEAK HOUR LOS  
 = NOON PEAK HOUR LOS  
 = PM PEAK HOUR LOS  
 = Queue Issues by Approach

UNC Health Care - Eastowne Campus  
 Transportation Impact Analysis  
 SENSITIVITY TEST INTERSECTION LOS & QUEUE RESULTS

NOT TO SCALE

