



Coulter Jewell Thames, PA

MAIN OFFICE
111 WEST MAIN STREET
DURHAM, NC 27701
p 919.682.0368 f 919.688.5646

Planning for the Future

11SIXTY5 WEAVER DAIRY ROAD

1165 Weaver Dairy Road

SPECIAL USE PERMIT APPLICATION

STATEMENT OF JUSTIFICATION

25 January 2018

PROJECT SUMMARY

The project site is located on the south side of Weaver Dairy Road east of Martin Luther King Jr Blvd between Timberlyne Shopping Center and the recently completed Weaver Crossing. The proposed use is a mixed commercial / retail center with a parking deck.

The parcel is owned by Comprop, a business located in Chapel hill. The 1.98 acre parcel is currently vacant, but is the former location of a small Montessori preschool. The site was very under-developed compared with the new building that has occurred over the past 10 years.

There has been a lot of recent development in the surrounding area over the past 10 years. Within 1000 feet of the project site those new developments have included expansion of Chapel Hill North retail center, clinic and office space on the north side of Weaver Dairy Road, 1701 North Apartments, a new daycare center, and the Weaver Crossing development. The site is currently zoned MU-OI-1. A concurrent rezoning is being requested to allow a higher density on the site.

SPECIAL USE PERMIT – REQUIRED FINDINGS OF FACT

We believe the project satisfies all the required findings as stated in section 4.5.2 of the Town's Land Use Management Ordinance. These findings and our responses to how we address each finding are submitted as follows:

Finding #1: The use is located, designed, and proposed to be operated so as to maintain or promote the public health, safety, and general welfare.

The project will be operated as a commercial and retail center with on-site parking. The buildings will comply with all current building and safety codes. There will be good visual and pedestrian connectivity between the public right of way and the entry plaza, walls will have railings, sidewalk will have curb edges, and there will be provision for bicycle parking. There is existing sidewalk on the street frontage, and new pedestrian paths will be created between the street and the plaza, the street and the entry, and between this site and the adjacent development.

Traffic and Pedestrian Circulation

There are currently two vehicular entries to the site from Weaver Dairy Road. The western entry will be closed to reduce conflict between turning vehicles and through traffic on the street. The access easement between the site and the adjacent Weaver Crossing will be utilized to aid vehicular circulation.

A traffic study was completed in relation to this project. The study found no intersections that would experience deficit traffic operations due to the development of this project. The study also finds that the proposed vehicular entry, in its current location, will meet or exceed acceptable conditions.

There is an existing sidewalk on Weaver Dairy Road. The project includes a public plaza accessible from the sidewalk. There is also pedestrian access midway through the site between the proposed project and the adjacent Weaver Crossing. The project scope includes improvement of the existing crosswalk across Weaver Dairy Road with the addition of warning signage and LED lighting. Along the east side of the site is a topographic drop into a Duke Energy easement and a fenced property line backing up to the service areas of adjacent Timberlyne Plaza building. The owner will grant a reasonable easement to any future redeveloper of the parcels to the east. In addition, the site stormwater treatment facility has been sized to accommodate 300 sf of additional pavement to allow for a future conveniently located sidewalk from the adjacent site.

Utilities

The project parcel is well serviced and ideally sited for denser development. Water is available from Weaver Dairy Road. Sanitary sewer service is available at the south edge of the parcel. And electric service runs through the eastern edge of the parcel. The area is service by natural gas. There will be no need for public upgrades to utilities to serve the new facility.

The project will include the addition of a fire hydrant at the street and the new building will be sprinklered. There is a fire station location approximately 1000 feet to the west.

Refuse will be collected by Orange County (recycling) and by the Town of Chapel Hill (trash). Should the Town not be able to satisfactorily collect refuse, the owner will contract with a private collection service.

The project has been reviewed by the Town Public Works Dept, Planning, Solid Waste, Orange County Solid Waste, and by OWASA. In addition, the applicant has been consulting with Duke Energy and with PSNC and design is conforming to existing utility rules and requirements.

Stormwater Management

The site is currently 16% impervious with no stormwater management. The proposed condition is 66% impervious. The project site generally drains from the southwest to the northeast. There are no streams or wetlands on site. Stormwater detention and treatment will be included on site in underground filters and holding vaults. Stormwater treatment will conform with state regulations as administered by the Town Stormwater Department.

Finding #2: The use complies with all required regulations and standards of the LUMO including all applicable provisions of articles 3 and 5, the applicable specific standards contained in the supplemental use regulations (article 6) and with all other applicable regulations.

The 1165 Weaver Dairy development is designed to be in conformance with Town regulations and development standards. All dimensional, design, and development standards are in conformance with applicable LUMO standards except for landscape buffers and steep slope disturbance for which we are requesting modifications. We are requesting a concurrent zoning amendment to allow for more built square footage than would currently be allowed, and the application also requests modifications to three of the four landscape buffers, and to the amount of steep slope disturbance.

Section 4.5.6 of the LUMO allows for modification to the regulations.

4.5.6 Permitted Modifications of Regulations.

Where actions, designs, or solutions proposed by the applicant are not literally in accord with applicable special use regulations, general regulations, or other regulations in this appendix, but the town council makes a finding in the particular case that public purposes are satisfied to an equivalent or greater degree, the town council may make specific modification of the regulations in the particular case. Any modification of regulations shall be explicitly indicated in the special use permit, or modification of special use permit.

- ***Modification to Steep Slope Disturbance***

LUMO section 5.3.2 specifies that the disturbance of steep slopes is to be minimized in order to protect water bodies from the effects of erosion on water quality, to protect plant and animal habitat, and to preserve the natural beauty and economic value of the Town's wooded hillsides.

The stated limit to disturbance of steep slopes is one quarter of existing steep slopes on site.

In this case the total amount of steep slope on site is 5,735 square feet, entirely located alongside the Duke Energy transmission line. This steep slope was created when dirt was pushed aside to create a more level area under the power lines for ease of utility maintenance. The steep slopes on site are not related to water bodies or wetlands, and there are not wooded. When the project is complete there will still be evidence of elevation change. The final grading will include a parking deck where the steep slope exists and the top of that slope at the foot of the parking deck will be replanted with columnar trees, understory trees, and shrubs acceptable to both the Town and to Duke Energy. The street plaza will also show elevation change. The western portion of the plaza will sit flush with the street, but the eastern corner will sit above the street behind a short retaining wall to provide separation from the vehicular entry drive.

- *Modification to North / Street Landscape Buffer*

The requirement at the street edge of the property is a 30' wide buffer with 13 large trees, 26 small trees, and 85 shrubs. The modification is requested for both the buffer width and the plant quantity. During Concept review, both the Planning Commission and Council advocated for a pedestrian plaza between the building and the street. This space has been designed as an urban plaza with some amount of hardscape. Additional to the hardscape area, there are limitations on planting in the 30' wide power easement at the east, the 26' wide access driveway next to the easement, and the utility service easement area at the northwest corner of the site. This reduces the plantable frontage from 213 feet to 128' - an 85' or 40% reduction.

The applicant is requesting a reduction of width to approximately 18' – the width varies between 11' and 25'. We are also requesting a reduction of plant materials to 6 large trees and 14 small trees – 50% of the tree requirement. All the required shrubs will be installed. The proposed planting will produce a sense of separation from street traffic while keeping the connection between the plaza and the street sidewalk.

- *Modification to East / Utility Easement Landscape Buffer*

The requirement to the east is a 10' wide buffer with 16 large trees, 28 small trees, and 48 shrubs. The modification is requested for buffer location and the plant quantity. This section of the site is located in a 30' wide electric utility easement. The request is to install the buffer at the western edge of the easement between the power lines and the parking deck structure. The adjacent land use is retail and general business, similar to the proposed project uses. As such the need for separation of spaces and privacy is lessened.

The applicant is requesting a reduction of plant materials to 28 columnar and understory trees and 14 small trees – 64% of the tree requirement. All the required shrubs will be installed. The proposed planting will be located 25'-35' from the property line.

- *Modification to West Landscape Buffer*

The requirement to the west is a 10' wide buffer with 18 large trees, 31 small trees, and 53 shrubs. The modification is requested for both buffer width and the plant quantity. This section of the site is located adjacent to the parking lot of Weaver Crossing, a development of retail and general business uses similar to the proposed project uses. As such the need for separation of spaces and privacy is lessened. The adjacent owner has planted a 10' wide area with shrubs and midsize evergreens to screen their parking area. The project site is narrow and limited to the east by the power easement. In order to reduce impervious on site and provide parking for the proposed building the developer is proposing parking in a deck structure behind the building. Deck parking is only efficient at a dimension allowing double loaded aisles and side by side ramps. This leaves the buffer area between 7 and 10' wide with structures at the edge of the buffer.

The applicant is requesting a reduction of buffer width to 7' wide, and a one third reduction of plant materials to 12 large trees (many columnar), 20 understory trees and 35 shrubs. The reduced buffer alongside existing adjacent buffer would provide some separation between the two developments, but as both are commercial uses and pedestrian and vehicular cross connection is expected, the proposed buffers would provide appropriate screening and privacy.

Finding #3: The use is located, designed and proposed to be operated so as to maintain or enhance the value of contiguous property, or the use is a public necessity.

The current use is a vacant site left after the closing of a small Montessori pre-school. It is expected that the new project will maintain or enhance the value of contiguous property for the following reasons:

- The proposed mixed use commercial and retail would complement the adjacent office, commercial, clinic and retail uses and serve the nearby residential areas as well as the larger Town population.
- Located near the MLK intersection with Hwy I-40 it is also well-sited to serve the larger community.
- The project will provide commercial and office space that supports existing area development.
- It is in line with more dense development as called out in the Town's 2020 Comprehensive Plan and area study. The proposed use is allowed in the current

MU-OI-1 zone but a rezoning application is being submitted concurrently to allow for a denser development.

- The proposed project will provide significant aesthetic improvements: a new building compatible with recent nearby development, public pedestrian spaces, parking in a deck barely visible from the street.
- The new project will improve pedestrian infrastructure and connections in the area.
- Stormwater mitigation will meet the current Town requirements.
- The new project will add to the Town's commercial tax base.

Finding #4: The use conforms with the general plans for the physical development of the town as embodied in the appendix and in the comprehensive plan.

The project site is located on the south side of Weaver Dairy Road just east of Martin Luther King Jr Blvd. It is in the Future Focus Discussion Area 2 called out in the 2020 Comprehensive Plan, and is also in the area studied by the Northern Area Task Force.

- *2020 Comprehensive Plan*

The proposed project complies with the all applicable goals as specified in the 2020 Plan.

Theme 1: A Place For Everyone - The proposed development will be a non-residential mixed use building with public plaza accessible from the street. The infill building between Tymberline Shopping Center and Weaver Crossing will allow for businesses to develop in north Chapel Hill. Specific goals addressed include:

- The plaza provides and exterior space of public use (PFE.1)
- Pedestrian access through the site and improvement of the Weaver Dairy crosswalk add to the area pedestrian connectivity (PFE.1)

Theme 2: Community Prosperity and Engagement - The project site is located at the southeast corner of Martin Luther King Jr Blvd and Weaver Dairy Road. The proposed development represents an increased intensity of use in an area that is already fully serviced with infrastructure. The Owner is a local business owner with a desire to develop within Chapel Hill and attract expanding and new business to the area.

Specific goals addressed include:

- The project adds to the Town's commercial tax base (CPE.1)
- The developer is a local Chapel Hill business (CPE.2)
- Pedestrian access through the site and improvement of the Weaver Dairy crosswalk add to the area pedestrian connectivity (CPE.3)

Theme 3: Getting Around - The project site has frontage on Weaver Dairy Road and is already connected to the rest of the community by sidewalks, bike lanes, and local and regional bus service. There is an existing Chapel Hill Transit stop just east of the site, and two Triangle Transit routes operate on Martin Luther King Jr. Blvd to the west. Additionally, the project is located very close to many residential units which will allow some users to access the site on foot or by bicycle. The project will provide covered bicycle parking.

Specific goals addressed include:

- The project serves users of all modes of transit (GA.1, GA.3)
- Pedestrian access through the site and improvement of the Weaver Dairy crosswalk add to the area pedestrian connectivity (GA.2)
- The parking deck allows for enough parking to serve the tenants while using less land area and limited the impervious surface (GA.6)
- The project location supports bicycle and moped/motorcycle use as well as public transit and car (GA.6, GA.8)

Theme 4: Good Places, New Spaces - The project site is located in an area identified as a Development Opportunity Area – Town Village Center in the 2020 Plan. The denser development promotes pedestrian and bicycle use. And the public plaza on the street frontage creates a space for community use.

Specific goals addressed include:

- The plaza provides open and accessible common space for individual and community use (GPNS.7)
- Easy access from the highway and from public transit, walking and biking make this business location accessible to people who do not have cars (GPNS.8)

Theme 5: Nurturing Our Community - The proposed development will provide tree coverage and stormwater management on site to meet or exceed the Town's standard requirements. The design takes advantage of the long narrow site to put the building and public plaza at the street, thereby screening a parking garage at the back of the site. The multi-level parking deck provides accommodation for the building tenants and visitors, thereby reducing impervious area. The architect plans for use of local materials, energy efficiency, a high albedo (reflecting) roof, as well as the stormwater treatment and planting to reduce the impact of the building on the environment.

Specific goals addressed include:

- Stormwater management, use of local materials, high efficiency building systems, and high reflectivity roofing improve water quality and reduce heat island effect. (NOC.2, NOC.7, NOC.8)
 - While not adding to the park system, the bicycle friendly nature of the location and facility encourage the use of Town trails and bike lanes. (NOC.4)
- The plaza provides open and accessible common space for individual and community use (GPNS.7)

Theme 6: Town and Gown Collaboration - The proposed development will be designed to allow flexibility of fit up and is open to all general business uses.

Specific goals addressed include:

- The building is designed to accommodate many general business users including University related uses. (TGC.6)

- *Northern Area Task Force Report*

The Northern Area Task Force Report calls for this parcel to be developed in a commercial use. The proposed development meets the Plan's goals as follows:

Goal 1 – Gateway Entrance The parcel is located in the portion of the neighborhood which is designated as a Gateway Entrance. The architecture will be compatible with recent development at the corner, and the entry plaza will contain public art and provide a community gathering spot. The development specifically conforms with:

- Objective 1 - Public art and interesting architectural design will be visible from the street. The plaza will serve as a small gathering place and be accessible to the public.

Goal 2 – Neighborhood Protection The development as designed will focus activity on the street. Vehicular access only from Weaver Dairy Road and from the adjacent commercial Weaver Crossing development will keep vehicular traffic away from nearby residential streets. It will continue to focus commercial and retail uses on the Weaver Dairy arterial and buffer vehicular circulation from the nearby residential neighborhoods, as well as providing commercial and retail opportunities for nearby residents. The development specifically conforms with:

- Objective 1 – The development facing and oriented toward Weaver Dairy protects existing residential neighborhoods from light, noise, and visual impacts of the new development.
- Objective 3 – The density of the project is oriented toward Weaver Dairy Road and not toward the residential uses south of the site.
- Objective 6 – Vehicle access to the site is from Weaver Dairy Road and from the adjacent commercial development and does not encourage traffic through nearby residential neighborhoods.

Goal 3 – Protect, Restore and Enhance the Environmental Quality of the Area The site is currently vacant with gravel and asphalt remnants from previous development, and surface stormwater runoff. The new development will provide underground stormwater mitigation. It will also increase the tree coverage on site. There will be publicly accessible pedestrian gathering space near the street. The development specifically conforms with:

- Objective 4 – The development's plaza area is publicly accessible open space.
- Objective 8 – Redevelopment of this site will eventually result in more vegetation and stormwater management than currently exist there.

- Objective 9 – Power lines will be buried.

Goal 4 – Development that Supports Active Pedestrian Environment and Promotes Transit Use

The site is on Weaver Dairy Road near Martin Luther King Jr Blvd – streets supported by public bus service, both Chapel Hill Transit and Go Triangle commuter service. The project will also add to pedestrian connectivity in the area with additional sidewalk routes off the street. There will be bicycle parking provided on site and uses within walking distance to serve nearby commercial and health care users and residents. The development specifically conforms with:

- Objective 1 – The development works toward concentrating commercial development at an existing commercial center.
- Objective 2 – The higher density use encourages public transit use.
- Objective 3 – The 3 story building is appropriately scaled for the area.
- Objective 4 – The development is oriented to the transit corridor – Weaver Dairy Road and parking is out of site from the street, encouraging public transit use.
- Objective 6 – The development does not include drive through services.
- facing and oriented toward Weaver Dairy protects existing residential neighborhoods from light, noise, and visual impacts of the new development.

Goal 5 – Pedestrian and Bicycle Mobility Pedestrian amenities will be provided just off the right of way with the installation of a welcoming pedestrian plaza. The development specifically conforms with:

- Objective 3 – The plaza will provide publicly accessible benches, lighting and shade.
- Objective 4 – The existing crosswalk across Weaver Dairy Road will be made safer with warning signage and LED lighting.
- Objective 5 – The new development has off street connectivity with Weaver Crossing commercial center to the west, and is providing for future connectivity to its eastern neighbor.
- Objective 8 – The space between the street sidewalk and the building will have trees, plantings, and hardscape areas scaled to the street. The building has a front façade with two planes for interest.

Goal 6 – Comprehensive Transportation System Promoting Bicycling, Walking, and Transit Use

The site is located within easy walking distance of public bus service and will provide bicycle parking and interior sidewalks. There will be shading and benches for pedestrian use with appropriate night lighting for safe after-hours use. The development specifically conforms with:

- Objective 1 – The development has located most of the parking away from and hidden from the street in a structured parking deck.
- Objective 3 – The use of space between the building and street for pedestrian plaza only, and not for parking, creates a pleasing shaded usable streetscape. The overhang of upper floors adds to this visual interest and creates some sheltered pedestrian space.

- Objective 5 – The removal of one existing driveway curb cut allows for better sidewalk function (fewer driveway crossings) and encourages the use of cross access between this property and the development to the west.

-

Goal 7 – Promotion of Design of Safe, Comfortable, Active and Visually Interesting Buildings and Streetscapes

The building is being designed to be visually compatible with recent area construction and that architecture will be reviewed by the Community Design Commission at the SUP and Final Plan stages. The building is being set back on the site to provide for a generous pedestrian use area between the building and the street, with multiple access points from the existing public sidewalk. There will be no parking in front of the building, minimal surface parking in general, and the parking deck will be located behind the building to reduce its visual impact and create a more pedestrian friendly atmosphere. The development specifically conforms with:

- Objective 1 – The plaza encourages ground level pedestrian activity.
- Objective 3 – Lighting at the plaza area creates a safe pedestrian environment for day or night use.
- Objective 4 – The break in the front building façade create a form to reflect the street angle and the transition between this project and adjacent projects with larger setbacks.
- Objective 5 – The bicycle parking on site encourages bicycle pathways into the commercial development.
- Objective 6 – The 19’ setback with modified landscape buffer at the street brings this building close to the street.
- Objective 8 – The development includes a public plaza with seating.
- Objective 10 – The street tree plantings continue some of the street trees used on the adjacent site to the west.
- Objective 11 – The development includes a landscaped streetside area between the building and the sidewalk.
- Objective 13 – Parking is located away from the street, and circulation between this and adjacent property is encouraged by parking deck access from both the Weaver Dairy driveway and from the adjacent development parking lot.
- Objective 14 – The service area for this building is located both within the parking deck, and also at the back of the building away from streets and most pedestrian ways.



Coulter Jewell Thames, PA

MAIN OFFICE
111 WEST MAIN STREET
DURHAM, NC 27701
p 919.682.0368 f 919.688.5648

Planning for the Future

November 30, 2017

Ms Kay Pearlstein
Town of Chapel Hill Planning Department
405 Martin Luther King Jr Blvd
Chapel Hill, NC 27514

RE: SPECIAL USE PERMIT APPLICATION – PROJECT NARRATIVE
11SIXTYS WEAVER DAIRY ROAD

Kay:

Enclosed is the Special Use Permit application for the 11SIXTYS Weaver Dairy Road commercial project.

The proposed development is located on the south side of Weaver Dairy Road east of Martin Luther King Jr Blvd between Timberlyne Shopping Center and the recently completed Weaver Crossing. The site formerly housed a small Montessori school which was closed a few years ago and the building demolished in 2016. There are a few improvements remaining on site – a circular drive, some gravel parking, a well, and some playground areas. These items will all be demolished.

The proposed project is to be a 48,624 sf 3 story structure with retail on the main floor facing the street, and office / business space in the remainder of the building. There will be a part to the structure, a parking deck containing 225 parking spaces in three covered levels and one rooftop open level. This deck will be attached to and located behind the building, with vehicular access from Weaver Dairy Road and also from the adjacent Weaver Crossing site. A few surface parking spaces will be accommodated in the entry drive, reserved for short term retail visitors. Bicycle parking will be provided near the street plaza with the majority of bike parking accommodated in the covered parking deck near the elevators.

Stormwater mitigation for increased impervious will be contained in and underground facility under the parking deck. All tree coverage requirements will be provided by new plantings on site. A full landscape buffer will be provided on the south property line. The applicant is requesting buffer modifications on the other three sides. The east landscape buffer will be the required width but without tall canopy trees

as it is located near overhead electrical lines. That buffer will also be located approximately 25'-35' from the property line and at an elevation of the parking deck. The plant material acceptable to Duke Energy is smaller narrow shrubs and smaller understory trees at the outer edge of their easement and away from the wires. This configuration also leaves them the flatter lower area under the wires to be able to drive their maintenance equipment along the easement. The western landscape buffer will contain two thirds of the required plant material in an area that in places is up to 4' narrower than required. The adjacent project, Weaver Crossing, has already planted buffer on their side and their plant material is shown on our plans. The street landscape buffer is being provided at the required width, but with fewer plantings to accommodate hardscape in a more interactive plaza area to be used by both tenants and the general public. There are many utilities coming into the project from Weaver Dairy Road, as well as the vehicular access and the almost 30' wide electric easement, greatly reducing the area we have for planting trees. We propose this buffer to have 50% of required trees, and all the required shrubs.

The Town commissioned a TIS which is included in this application. It was completed in June 2015 and revised in June 2017.

The project has gone through the Town's Concept Plan review process three times. It was presented to the Community Design Commission on the 27 May 2015 as two buildings with surface parking in a fairly suburban style layout. Response from the CDC at that time was basically that they would like to see a more urban type layout with pedestrian interaction opportunities between Weaver Dairy Road and the entry. The second concept was presented 27 October 2015 as a multi story secure self storage facility with retail on the ground floor facing the street. This use was questionable to the CDC and the Council, as they indicated a preference for self storage uses to be located in a less visible site. But that layout set the multi story building close to the street with an opportunity for a streetside plaza and without a lot of surface parking which was praised by the two groups. The third concept presented to the CDC 27 September 2016 and Council on 17 October 2016 was more acceptable and is the concept being presented in this application. It included an office / commercial / retail type building set close to the street with a parking deck behind and vehicular connectivity to the adjacent recently completed Weaver Crossing development to the west, as well as a pedestrian space at the street.

Sincerely,
Coulter Jewell Thames, PA
Wendi Ramsden RLA



cc. Mike Slomiany, Pete Slomiany, - Owners
Andy King, Scott LaPorte - Architects, MHA Works



501 WASHINGTON STREET
SUITE G
DURHAM, NC 27701
P 919.682.2870
F 919.682.5369

11SIXTY5 Weaver Dairy - Statement of Public Art:

It is the design intent of the project to include a public art element inside of the public plaza along Weaver Dairy Rd. The public art element will consist of a commissioned sculpture by a local artist that helps to provide a defining marker for the site. It is the intent that this element be made of steel or iron and draw upon elements of the architecture and surrounding environment. Whether the sculpture is completely static or includes a kinetic element is still to be determined.

SPECIAL USE PERMIT APPLICATION



TOWN OF CHAPEL HILL
Planning Department
405 Martin Luther King Jr. Blvd.
Chapel Hill, NC 27514
phone (919) 969-5066 fax (919) 969-2014
www.townofchapelhill.org

Parcel Identifier Number (PIN): 9880 35 0595 Date: REV 22 Feb 2018

Section A: Project Information

Project Name: 11SIXTY5 Weaver Dairy Road
Property Address: 1165 Weaver Dairy Road Zip Code: 27514
Use Groups (A, B, and/or C): B, C Existing Zoning District: MU-OI-1 (Proposed OI-3)
Project Description: Office, retail, and medical clinic in a 3-story building with attached parking deck.

Section B: Applicant, Owner, and/or Contract Purchaser Information

Applicant Information (to whom correspondence will be mailed):

Name: Coulter Jewell Thames, PA Attn: Wendi Ramsden
Address: 111 West Main Street
City: Chapel Hill State: NC Zip Code: 27701
Phone: 919-682-0368 Email: wramsdn@cjtpa.com

The undersigned applicant hereby certifies that, to the best of their knowledge and belief, all information supplied with this application and accurate.

Signature: on file Date: _____

Owner/Contract Purchaser Information:

Owner **Contract Purchaser**

Name: Comprop LLC
Address: 727 Eastown Drive, Suite 300-D
City: Chapel Hill State: NC Zip Code: 27514
Phone: _____ Email: _____

The undersigned applicant hereby certifies that, to the best of their knowledge and belief, all information supplied with this application and accurate.

Signature: on file Date: _____

Click [here](#) for application submittal instructions.



PROJECT FACT SHEET

TOWN OF CHAPEL HILL
Planning Department

Section A: Project Information

Use Type: (check/list all that apply)

Office/Institutional Residential Mixed-Use Other: Retail, Medical Clinic

Overlay District: (check all that apply)

Historic District Neighborhood Conservation District Airport Hazard Zone

Section B: Land Area

Net Land Area (NLA): Area within zoning lot boundaries		NLA=	78,557	sq. ft.
Choose one, or both, of the following (a or b), not to exceed 10% of NLA	a) Credited Street Area (total adjacent frontage) x ½ width of public right-of-way	CSA=		sq. ft.
	b) Credited Permanent Open Space (total adjacent frontage) x ½ public or dedicated open space	COS=		sq. ft.
TOTAL: NLA + CSA and/or COS = Gross Land Area (not to exceed NLA + 10%)		GLA=	86,412	sq. ft.

Section C: Special Protection Areas, Land Disturbance, and Impervious Area

Special Protection Areas: (check all those that apply)

Jordan Buffer Resource Conservation District 100 Year Floodplain Watershed Protection District

Land Disturbance	Total (sq. ft.)
Area of Land Disturbance (Includes: Footprint of proposed activity plus work area envelope, staging area for materials, access/equipment paths, and all grading, including off-site clearing)	83,200 sf
Area of Land Disturbance within RCD	0
Area of Land Disturbance within Jordan Buffer	0

Impervious Areas	Existing (sq. ft.)	Demolition (sq. ft.)	Proposed (sq. ft.)	Total (sq. ft.)
Impervious Surface Area (ISA)	15,363 sf	15,363 sf	58,219 sf	58,219 sf
Impervious Surface Ratio: Percent Impervious Surface Area of Gross Land Area (ISA/GLA)%	17.78%			67.37%
If located in Watershed Protection District, % of impervious surface on 7/1/1993				



PROJECT FACT SHEET

TOWN OF CHAPEL HILL

Planning Department

Section D: Dimensions

Dimensional Unit (sq. ft.)	Existing (sq. ft.)	Demolition (sq. ft.)	Proposed (sq. ft.)	Total (sq. ft.)
Number of Buildings	0	0	48,624	48,624
Number of Floors	0	0	3	
Recreational Space			n/a	

Residential Space

Dimensional Unit (sq. ft.)	Existing (sq.ft.)	Demolition (sq. ft.)	Proposed (sq. ft.)	Total (sq. ft.)
Floor Area (all floors – heated and unheated)				
Total Square Footage of All Units				
Total Square Footage of Affordable Units				
Total Residential Density				
Number of Dwelling Units				
Number of Affordable Dwelling Units				
Number of Single Bedroom Units				
Number of Two Bedroom Units				
Number of Three Bedroom Units				

Non-Residential Space (Gross Floor Area in Square Feet)

Use Type	Existing	Proposed	Uses	Existing	Proposed
Commercial	0	2,557			
Restaurant			# of Seats		
Government					
Institutional					
Medical	0	13,820			
Office	0	32,247			
Hotel			# of Rooms		
Industrial					
Place of Worship			# of Seats		
Other					

Dimensional Requirements		Required by Ordinance	Existing	Proposed
Setbacks (minimum)	Street	0	n/a	19'
	Interior (neighboring property lines)	0	n/a	6.8'
	Solar (northern property line)	0	n/a	30'
Height (maximum)	Primary	n/a	n/a	
	Secondary	n/a	n/a	
Streets	Frontages	15'	212.79'	212.79'
	Widths	15'	202'	202'



Section F: Adjoining or Connecting Streets and Sidewalks

Note: For approval of proposed street names, contact the Engineering Department.

Street Name	Right-of-Way Width	Pavement Width	Number of Lanes	Existing Sidewalk*	Existing Curb/Gutter
Weaver Dairy Road	Var	Min 78' w median	4	<input checked="" type="checkbox"/> Yes	<input checked="" type="checkbox"/> Yes
				<input type="checkbox"/> Yes	<input type="checkbox"/> Yes

List Proposed Points of Access (Ex: Number, Street Name):

*If existing sidewalks do not exist and the applicant is adding sidewalks, please provide the following information:

Sidewalk Information			
Street Names	Dimensions	Surface	Handicapped Ramps
			<input type="checkbox"/> Yes <input type="checkbox"/> No <input type="checkbox"/> N/A
			<input type="checkbox"/> Yes <input type="checkbox"/> No <input type="checkbox"/> N/A

Section G: Parking Information

Parking is not required in OI-3 zone Parking required in non-Town Center zones would be as follows:

Parking Spaces	Minimum	Maximum	Proposed
Regular Spaces	149	225	217
Handicap Spaces	6	7	14
Total Spaces	155	232	231
Loading Spaces	2	n/a	2
Bicycle Spaces	20	n/a	24 (12 loops)
Surface Type	Asphalt and concrete		

Section H: Landscape Buffers

Location (North, South, Street, Etc.)	Minimum Width	Proposed Width	Alternate Buffer	Modify Buffer
North (street)	30'	30'	<input type="checkbox"/> Yes	<input checked="" type="checkbox"/> Yes
West	10'	8'	<input type="checkbox"/> Yes	<input checked="" type="checkbox"/> Yes
South	10'	10'	<input type="checkbox"/> Yes	<input type="checkbox"/> Yes
East	10	10' in util easmt	<input type="checkbox"/> Yes	<input checked="" type="checkbox"/> Yes



PROJECT FACT SHEET

TOWN OF CHAPEL HILL

Planning Department

Section I: Land Use Intensity

Existing Zoning District: MU-OI-1

Proposed Zoning Change (if any): OI-3

Zoning – Area – Ratio			Impervious Surface Thresholds			Minimum and Maximum Limitations	
Zoning District(s)	Floor Area Ratio (FAR)	Recreation Space Ratio (RSR)	Low Density Residential (0.24)	High Density Residential (0.50)	Non-Residential (0.70)	Maximum Floor Area (MFA) = FAR x GLA	Minimum Recreation Space (MSR) = RSR x GLA
OI-3	.566	n/a			.70	48,909 sf	n/a
TOTAL							
RCD Streamside		0.01					
RCD Managed		0.019					
RCD Upland							

Section J: Utility Service

Check all that apply:

Water	<input checked="" type="checkbox"/> OWASA	<input type="checkbox"/> Individual Well	<input type="checkbox"/> Community Well	<input type="checkbox"/> Other
Sewer	<input checked="" type="checkbox"/> OWASA	<input type="checkbox"/> Individual Septic Tank	<input type="checkbox"/> Community Package Plant	<input type="checkbox"/> Other
Electrical	<input checked="" type="checkbox"/> Underground	<input type="checkbox"/> Above Ground		
Telephone	<input checked="" type="checkbox"/> Underground	<input type="checkbox"/> Above Ground		
Solid Waste	<input type="checkbox"/> Town	<input checked="" type="checkbox"/> Private trash pickup, County recyclable pickup		



**SPECIAL USE PERMIT APPLICATION
SUBMITTAL REQUIREMENTS
TOWN OF CHAPEL HILL
Planning Department**

The following must accompany your application. Failure to do so will result in your application being considered incomplete. For assistance with this application, please contact the Chapel Hill Planning Department (Planning) at (919) 969-5066 or at planning@townofchapelhill.org.

X	Application fee (including Engineering Review fee) (refer to fee schedule)	Amount Paid \$	23,525
X	Pre-application meeting –with appropriate staff		
X	Digital Files – provide digital files of all plans and documents		
X	Recorded Plat or Deed of Property		
X	Project Fact Sheet		
X	Traffic Impact Statement – completed by Town’s consultant (or exemption)		
X	Description of Public Art Proposal		
X	Statement of Justification		
X	Response to Community Design Commission and Town Council Concept Plan comments		
n/a	Affordable Housing Proposal, if applicable		
n/a	Provide existing Special Use Permit, if Modification		
X	Mailing list of owners of property within 1,000 feet perimeter of subject property (see GIS notification tool)		
X	Mailing fee for above mailing list (mailing fee is double due to 2 mailings)	Amount Paid \$	112.00
X	Written Narrative describing the proposal		
	Resource Conservation District, Floodplain, & Jordan Buffers Determination – necessary for all submittals		
	Jurisdictional Wetland Determination – if applicable		
	Resource Conservation District Encroachment Exemption or Variance (determined by Planning)		
	Jordan Buffer Authorization Certificate or Mitigation Plan Approval (determined by Planning)		
X	Reduced Site Plan Set (reduced to 8.5” x 11”)		

Stormwater Impact Statement (1 copy to be submitted)

- a) Written narrative describing existing & proposed conditions, anticipated stormwater impacts and management structures and strategies to mitigate impacts
- b) Description of land uses and area (in square footage)
- c) Existing and proposed impervious surface area in square feet for all subareas and project area
- d) Ground cover and uses information
- e) Soil information (classification, infiltration rates, depth to groundwater and bedrock)
- f) Time of concentration calculations and assumptions
- g) Topography (2-foot contours)
- h) Pertinent on-site and off-site drainage conditions
- i) Upstream and/or downstream volumes
- j) Discharges and velocities
- k) Backwater elevations and effects on existing drainage conveyance facilities
- l) Location of jurisdictional wetlands and regulatory FEMA Special Flood Hazard Areas
- m) Water quality volume calculations
- n) Drainage areas and sub-areas delineated
- o) Peak discharge calculations and rates (1, 2, and 25-year storms)
- p) Hydrographs for pre- & post-development without mitigation, post-development with mitigation
- q) Volume calculations and documentation of retention for 2-year storm



**SPECIAL USE PERMIT APPLICATION
SUBMITTAL REQUIREMENTS
TOWN OF CHAPEL HILL
Planning Department**

- r) 85% TSS removal for post-development stormwater runoff
- s) Nutrient loading calculations
- t) BMP sizing calculations
- u) Pipe sizing calculations and schedule (include HGL & EGL calculations and profiles)

Plan Sets (10 copies to be submitted no larger than 24" x 36")

Plans should be legible and clearly drawn. All plan set sheets should include the following:

- Project Name
- Legend
- Labels
- North Arrow (North oriented toward top of page)
- Property boundaries with bearing and distances
- Scale (Engineering), denoted graphically and numerically
- Setbacks
- Streams, RCD Boundary, Jordan Riparian Buffer Boundary, Floodplain, and Wetlands Boundary, where applicable
- Revision dates and professional seals and signatures, as applicable

Cover Sheet

- a) Include Project Name, Project fact information, PIN, and Design Team

Area Map

- a) Project name, applicant, contact information, location, PIN, & legend
- b) Dedicated open space, parks, greenways
- c) Overlay Districts, if applicable
- d) Property lines, zoning district boundaries, land uses, project names of site and surrounding properties, significant buildings, corporate limit lines
- e) Existing roads (public & private), rights-of-way, sidewalks, driveways, vehicular parking areas, bicycle parking, handicapped parking, street names
- f) 1,000' notification boundary

Existing Conditions Plan

- a) Slopes, soils, environmental constraints, existing vegetation, and any existing land features
- b) Location of all existing structures and uses
- c) Existing property line and right-of-way lines
- d) Existing utilities & easements including location & sizes of water, sewer, electrical, & drainage lines
- e) Nearest fire hydrants
- f) Nearest bus shelters and transit facilities
- g) Existing topography at minimum 2-foot intervals and finished grade
- h) Natural drainage features & water bodies, floodways, floodplain, RCD, Jordan Buffers & Watershed boundaries



**SPECIAL USE PERMIT APPLICATION
SUBMITTAL REQUIREMENTS
TOWN OF CHAPEL HILL
Planning Department**

Detailed Site Plan

- a) Existing and proposed building locations
- b) Description & analysis of adjacent land uses, roads, topography, soils, drainage patterns, environmental constraints, features, existing vegetation, vistas (on and off-site)
- c) Location, arrangement, & dimension of vehicular parking, width of aisles and bays, angle of parking, number of spaces, handicapped parking, bicycle parking. Typical pavement sections & surface type.
- d) Location of existing and proposed fire hydrants
- e) Location and dimension of all vehicle entrances, exits, and drives
- f) Dimensioned street cross-sections and rights-of-way widths
- g) Pavement and curb & gutter construction details
- h) Dimensioned sidewalk and tree lawn cross sections
- i) Proposed transit improvements including bus pull-off and/or bus shelter
- j) Required landscape buffers (or proposed alternate/modified buffers)
- k) Required recreation area/space (including written statement of recreation plans)
- l) Refuse collection facilities (existing and proposed) or shared dumpster agreement
- m) Construction parking, staging, storage area, and construction trailer location
- n) Sight distance triangles at intersections
- o) Proposed location of street lights and underground utility lines and/or conduit lines to be installed
- p) Easements
- q) Clearing and construction limits
- r) Traffic Calming Plan – detailed construction designs of devices proposed & associated sign & marking plan

Stormwater Management Plan

- a) Topography (2-foot contours)
- b) Existing drainage conditions
- c) RCD and Jordan Riparian Buffer delineation and boundary (perennial & intermittent streams; note ephemeral streams on site)
- d) Proposed drainage and stormwater conditions
- e) Drainage conveyance system (piping)
- f) Roof drains
- g) Easements
- h) BMP plans, dimensions, details, and cross-sections
- i) Planting and stabilization plans and specifications

Landscape Protection Plan

- a) Rare, specimen, and significant tree survey within 50 feet of construction area
- b) Rare and specimen tree critical root zones
- c) Rare and specimen trees proposed to be removed
- d) Certified arborist tree evaluation, if applicable
- e) Significant tree stand survey
- f) Clearing limit line
- g) Proposed tree protection/silt fence location
- h) Pre-construction/demolition conference note
- i) Landscape protection supervisor note
- j) Existing and proposed tree canopy calculations, if applicable



**SPECIAL USE PERMIT APPLICATION
SUBMITTAL REQUIREMENTS
TOWN OF CHAPEL HILL
Planning Department**

Planting Plan

- a) Dimensioned and labeled perimeter buffers
- b) Off-site buffer easement, if applicable
- c) Landscape buffer and parking lot planting plan (including planting strip between parking and building, entryway planting, and 35% shading requirement)

Steep Slope Plan

- a) Classify and quantify slopes 0-10%, 10-15%, 15-25%, and 25% and greater
- b) Show and quantify areas of disturbance in each slope category
- c) Provide/show specialized site design and construction techniques

Grading and Erosion Control Plan

- a) Topography (2-foot contours)
- b) Limits of Disturbance
- c) Pertinent off-site drainage features
- d) Existing and proposed impervious surface tallies

Streetscape Plan, if applicable

- a) Public right-of-way existing conditions plan
- b) Streetscape demolition plan
- c) Streetscape proposed improvement plan
- d) Streetscape proposed utility plan and details
- e) Streetscape proposed pavement/sidewalk details
- f) Streetscape proposed furnishing details
- g) Streetscape proposed lighting detail

Solid Waste Plan

- a) Preliminary Solid Waste Management Plan
- b) Existing and proposed dumpster pads
- c) Proposed dumpster pad layout design
- d) Proposed heavy duty pavement locations and pavement construction detail
- e) Preliminary shared dumpster agreement, if applicable



**SPECIAL USE PERMIT APPLICATION
SUBMITTAL REQUIREMENTS
TOWN OF CHAPEL HILL
Planning Department**

Construction Management Plan

- a) Construction trailer location
- b) Location of construction personnel parking and construction equipment parking
- c) Location and size of staging and materials storage area
- d) Description of emergency vehicle access to and around project site during construction
- e) Delivery truck routes shown or noted on plan sheets

Energy Management Plan

- a) Description of how project will be 20% more energy efficient than ASHRAE standards
- b) Description of utilization of sustainable forms of energy (Solar, Wind, Hydroelectric, and Biofuels)
- c) Participation in NC GreenPower program
- d) Description of how project will ensure indoor air quality, adequate access to natural lighting, and allow for proposed utilization of sustainable energy
- e) Description of how project will maintain commitment to energy efficiency and reduced carbon footprint over time
- f) Description of how the project's Transportation Management Plan will support efforts to reduce energy consumption as it affects the community

Exterior Elevations

- a) An outline of each elevation of the building, including the finished grade line along the foundation (height of building measured from mean natural grade)

**1165 WEAVER DAIRY ROAD COMMERCIAL BUILDING
TRAFFIC IMPACT STUDY - UPDATE**

EXECUTIVE SUMMARY



Prepared for:

The Town of Chapel Hill
Public Works Department - Engineering

Prepared by:

HNTB North Carolina, PC

*343 East Six Forks Road
Suite 200
Raleigh, NC 27609*

NCBELS License #: C-1554

March 2018

HNTB

1165 WEAVER DAIRY ROAD COMMERCIAL BUILDING

TRAFFIC IMPACT STUDY - UPDATE

EXECUTIVE SUMMARY



Prepared for:

The Town of Chapel Hill

Public Works Department - Engineering

Prepared by:

HNTB North Carolina, PC

*343 East Six Forks Road
Suite 200
Raleigh, NC 27609*

NCBELS License #: C-1554

March 2018





EXECUTIVE SUMMARY

Project Overview

A new office and retail development tentatively named 1165 Weaver Dairy Road Commercial Building, to be located along Weaver Dairy Road to the east of NC 86 (Martin Luther King, Jr. Blvd), is being proposed in Chapel Hill. **Figure ES-1** shows the general location of the site. The project is anticipated to be fully complete by 2020, based on initial assumptions and information provided in a previous traffic impact study of the proposed site (see details below). This report analyzes the full build-out scenario for the year 2020 (one year after anticipated completion), and uses information developed from an assumed “no-build” scenario for 2020, as well as 2017 existing “base year” traffic conditions.

This traffic impact study document represents an update to the original *Weaver Dairy Road Commercial Building Traffic Impact Study*, submitted to the Town by HNTB in July 2015. All information from that study related to initial “existing” conditions and build-out year + 1 analyses are assumed to remain valid unless specifically updated and addressed in this traffic impact study update. The primary focus of the update is to analyze the impacts of several changes to the proposed site plan from what was analyzed in the original study, including a larger development density.

Figure ES-2 displays the preliminary updated concept plan of the 1165 Weaver Dairy Road Commercial Building project and nearby land uses and roadways. The proposed site concept plan shows a restricted right-turn in/right-turn out only (RIRO) driveway along Weaver Dairy Road. It also features an internal circulation driveway that would connect to the Weaver Crossing development and its internal circulation driveway aisles. The current plan includes one commercial building to be developed into a mixture of office and retail space. 225 on-site parking spaces will also be provided in a parking deck internal to the site parcel, along with 6-10 surface lot space near the site driveway connection to Weaver Dairy Road.

This report analyzes and presents the transportation impacts that the 1165 Weaver Dairy Road Commercial Building will have on the following intersections in the project study area:

- NC 86 (Martin Luther King, Jr. Boulevard) and Weaver Dairy Road
- NC 86 (Martin Luther King, Jr. Boulevard) and Weaver Crossing Site Access (Right-Turn In Only)
- NC 86 (Martin Luther King, Jr. Boulevard) and Sparrow Lane
- NC 86 (Martin Luther King, Jr. Boulevard) and Westminster Drive
- Weaver Dairy Road and Site Access Driveway #1 (RIRO)
- Weaver Dairy Road and Banks Drive

The impacts of the proposed site at the study area intersections will be evaluated during the AM, noon, and PM peak hours of an average weekday.

Existing Conditions

The study area contains two signalized intersections along Martin Luther King, Jr. Boulevard at Weaver Dairy Road and Westminster Drive. It also includes several existing and future unsignalized stop-controlled intersections. Site traffic is expected use the proposed access driveway and a cross-access connection with the Weaver Crossing development at NC 86. External u-turn movements may be necessary for site-related traffic, due to access restrictions along NC 86 and Weaver Dairy Road. Internal driveways on the preliminary site plan will circulate site traffic to designated parking areas.

NC 86 (Martin Luther King, Jr. Boulevard) is a major north-south arterial providing connectivity between downtown Chapel Hill, north and south Chapel Hill, the I-40 corridor, and Hillsborough. Weaver Dairy



Road is a minor east-west arterial providing connectivity through northern Chapel Hill. Remaining study area network roadways are either suburban collector streets or local neighborhood/commercial access streets.

Site Traffic Generation

With the addition of new peak hour trips during the weekday AM, noon, and PM peak hours, there are potential site traffic impacts to the study area intersections. **Table ES-1** shows the site trip generation details, with generation rates taken from the Institute of Transportation Engineers (ITE) *Trip Generation Manual*, Volume 9, 2012. To be conservative, no modifications of trip generation estimates was made to include potential multi-modal or “pass-by” type trips – though in reality, the proposed site location and land uses may reduce total vehicular trips for these factors.

**Table ES-1 - Weekday Vehicle Trip Generation Summary
 Proposed 1165 Weaver Dairy Road Commercial Building**

Trip Generation Statistic	Daily Volumes			AM Peak Hour Trips			Noon Peak Hour Trips			PM Peak Hour Trips		
	Enter	Exit	Total	Enter	Exit	Total	Enter	Exit	Total	Enter	Exit	Total
ITE “Raw” Trip Generation	492	492	984	51	11	62	43	39	82	35	67	102
Transit/Bike/Ped Trip Reductions	-0	-0	-0	-0	-0	-0	-0	-0	-0	-0	-0	-0
External Vehicle Trips (Driveway Volumes)	492	492	984	51	11	62	43	39	82	35	67	102
Pass-By Trips	-0	-0	-0	-0	-0	-0	-0	-0	-0	-0	-0	-0
External Vehicle Trips Added To Adjacent Streets (New Trips)	492	492	984	51	11	62	43	39	82	35	67	102
Original TIS Data	277	277	554	35	7	42	27	24	51	19	41	60

Background Traffic

Background traffic growth for the 2020 analysis year is expected to come from two sources - ambient regional traffic growth and specific development-related traffic growth. Town staff provided information for development-related traffic growth for eight Town-approved sites in the north Chapel Hill area near the project study area, some of which have been constructed since the original traffic study, but their effects were still included in the traffic volume development assumptions for this TIS Update. An ambient area-wide traffic growth percentage of 1.0 percent per year was applied to original TIS study traffic volumes based on information from the historic daily traffic growth patterns in the project study (NCDOT and Town of Chapel Hill daily traffic information) and consistent with recent traffic impact studies completed in the project study area.

Impact Analysis

Peak Hour Intersection Level of Service (LOS)

Existing traffic operations at all study area intersections are acceptable during all three peak hours analyzed. The projected ambient and background development traffic growth will increase impacts by 2018. Even with the addition of peak hour site-generated trips to the projected 2020 background traffic volumes, only one study area intersection is expected to experience deficient traffic operations in any



peak hour and additional study of this intersection suggests that operations may be better than reported delay and LOS values. A summary of the traffic operations for each intersection related to vehicular delays (intersection average as a whole if signalized, critical movement if stop-controlled) and the corresponding LOS is shown in **Table ES-2**.

**Table ES-2. Weaver Dairy Road Commercial Building
 LOS and Delay (Seconds/Vehicle) Summary**

Intersections	Peak Hour	2020 Build		2020 Mitigated	
		LOS	Delay	LOS	Delay
NC 86 (Martin Luther King Jr. Blvd) and Weaver Dairy Road	AM	D	41.8	N/A	N/A
	NOON	D	36.7	N/A	N/A
	PM	D	51.4	N/A	N/A
NC 86 (Martin Luther King Jr. Blvd) and Sparrow Lane (RIRO)#	AM	C	16.0	N/A	N/A
	NOON	C	18.5	N/A	N/A
	PM	F**	64.7**	N/A**	N/A**
NC 86 (Martin Luther King, Jr. Blvd) and Westminster Drive	AM	C	22.1	N/A	N/A
	NOON	B	17.4	N/A	N/A
	PM	C	27.7	N/A	N/A
Weaver Dairy Road and Site Driveway #1 (RIRO)#	AM	B	11.7	N/A	N/A
	NOON	B	10.4	N/A	N/A
	PM	B	10.8	N/A	N/A
Weaver Dairy Road and Banks Drive#	AM	B	12.3	N/A	N/A
	NOON	B	11.0	N/A	N/A
	PM	B	11.3	N/A	N/A

- Worst-Case LOS/Delay for Unsignalized/Stop-Controlled Critical Movement

** - Additional Analysis in SimTraffic Microsimulation tool indicates acceptable operations and queue lengths.

Access Analysis

Vehicular site access is to be accommodated via a restricted access driveway connecting to Weaver Dairy Road. An additional internal cross-access connection to the adjacent Weaver Crossing development is also shown on the site concept plan (see **Figure ES-2**). Both access points directly connect to the proposed three story parking deck on-site.

The proposed access concept would provide over 50 feet of driveway throat length along Weaver Dairy Road, which should be adequate for projected peak hour queues (less than one vehicle) exiting the driveway. The distances from the proposed site access driveway along Weaver Dairy Road from the signalized intersection at NC 86 (approximately 425 feet) and Banks Drive (approximately 250 feet) are acceptable, based on recommendations of 100 foot minimum corner clearance as set forth in the 2003 *NC DOT Policy on Street and Driveway Access to North Carolina Highways* and the 250 foot minimum along arterial streets specified in the 2005 *Town of Chapel Hill Design Manual*. The distance between the site driveway and the existing site driveway for the Weaver Crossing development to the west is approximately 200 feet, less than Town standards for driveways along an arterial facility (750 feet), though the impacts of both driveways are lessened by the fact that both will be RIRO-type intersections with eastbound Weaver Dairy Road.



Access from NC 86 would be provided by the current right-turn in only driveway for Weaver Crossing. Egress from the site would utilize internal Weaver Crossing driveway aisle connections to Sparrow Lane and the RIRO intersection connection to NC 86 northbound.

Access for pedestrians and bicyclists are excellent in the project study area. Sidewalks are present on both sides of Weaver Dairy Road throughout the study area and connectivity is available on at least one side of the street along many facilities in the project study area that connect to the Martin Luther King, Jr. Boulevard and Weaver Dairy Road. Crosswalks exist across the NC 86 intersections with Weaver Dairy Road and Westminster Drive and across Weaver Dairy Road immediately adjacent to the site. Striped bicycle lanes along NC 86, Weaver Dairy Road, Westminster Drive and the Weaver Dairy Road Extension currently exist in the study area.

Other Transportation-Related Analyses

Other transportation-related analyses relevant to the 2001 Town of Chapel Hill Guidelines for the preparation of Traffic Impact Studies were completed as appropriate. The following topics listed in **Table ES-3** are germane to the scope of this study.

Table ES-3. Other Transportation-Related Analyses

Analysis	Comment
Generalized Peak Hour and/or Daily V/C Analysis	Daily Volume/Capacity Ratio and generalized planning-level peak hour roadway link LOS analyses were not conducted for this study, as the proposed site is not expected to generate a significant amount of daily vehicular trips (less than 1,000 new trips) compared to existing daily vehicular trips along NC 86 (27,000 AADT), Weaver Dairy Road (13,000 AADT), and other study area roadways.
Turn Lane Storage Requirements	Storage bay lengths at study area intersections were analyzed using Synchro and HCM 95 th percentile (max) queue length estimates for the 2020 Build Scenario. No recommendations for improvements to storage bays are expected, based on the analysis results, other than to monitor and retune the Weaver Dairy Road and NC 86 (Martin Luther King, Jr. Blvd) intersection, as necessary, to contain left-turn vehicle queues within their current storage bays provided.
Appropriateness of Acceleration/Deceleration Lanes	<p>The site concept plan shows no specifics related to acceleration/deceleration lanes. Weaver Dairy Road in the vicinity of the site driveway has a 35 mph speed limit with no special acceleration or deceleration lanes for other development driveways, other than a short deceleration right-turn lane for the adjacent Weaver Crossing development driveway that is close to the functional area of the major NC 86/Weaver Dairy Road intersection and thus benefits from the right-turn lane to remove turning traffic flows near the larger intersection.</p> <p>The proposed 1165 Weaver Dairy Road Commercial Building access is further downstream of the major signalized intersection at NC 86. The projected volumes for this driveway do not cause capacity issues and do not necessitate the provision of an additional right-turn deceleration lane at this location.</p> <p>No other specific acceleration/deceleration lane issues were analyzed in the project study area.</p>



Mitigation Measures/Recommendations

Planned Improvements

There are no Town of Chapel Hill or North Carolina Department of Transportation improvement projects for study area facilities within the analysis year time frame of 2017-2020.

Background Committed Improvements

There are three specific private development projects (Charterwood, Weaver Crossing, and The Children's Campus of Chapel Hill) that have been completed or under construction and nearing full occupancy in the immediate vicinity of the proposed project since the original TIS study. Recommended improvements for these projects have been field verified and considered complete for the 2020 Build-out year + 1 analysis for the Weaver Dairy Road Commercial Building project.

No other background committed improvements from other private development projects are expected to be constructed by the 2020 Build-out year +1.

Applicant Committed Improvements

Based on the preliminary site plan and supporting development information provided, no external transportation improvements are shown, other than the RIRO access driveway request along eastbound Weaver Dairy Road. Internally, the Applicant is proposing a cross-access connection to the Weaver Crossing internal driveway aisles, to obtain better access to the NC 86 corridor.

Necessary Improvements

Based on traffic capacity analyses for the 2020 design year, and analyses of existing study area turning bay storage lengths and site access, the following improvements are recommended as being necessary for adequate transportation network operations (see **Figure ES-3**).

- 1) Monitor and retune the NC 86 (Martin Luther King, Jr. Boulevard) traffic signal with Weaver Dairy Road to ensure adequate left-turn/u-turn movement green time for the movements impacted by u-turns due to the 1165 Weaver Dairy Road Commercial Building project (northbound and westbound approaches). This improvement is recommended if the Weaver Dairy Road Commercial Building site is developed.
- 2) Include additional pedestrian warning signage at the site driveway access exit along Weaver Dairy Road (see **Figure ES-4**). This driveway's location is immediately adjacent to the unsignalized cross-walk across Weaver Dairy Road.

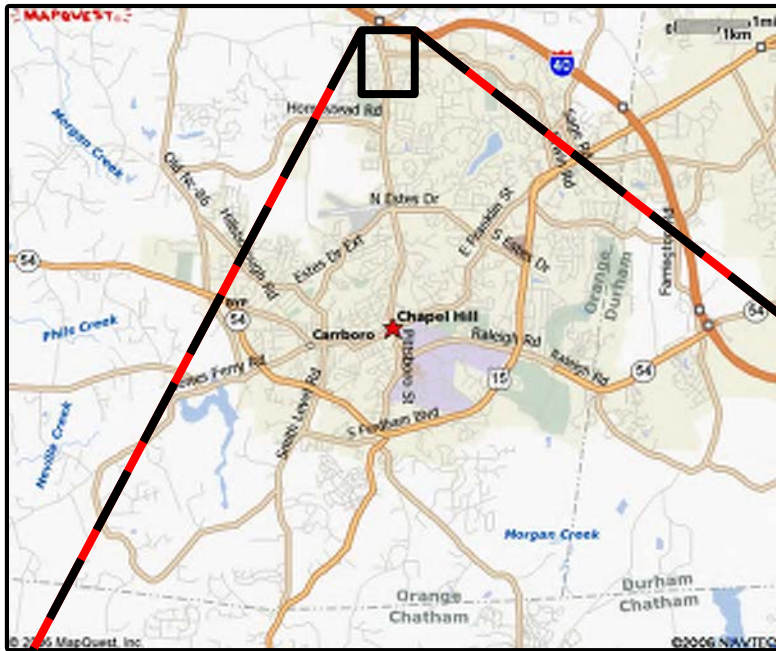

LEGEND

- = Existing Building Footprint
- = Existing Study Area Intersection
- = Proposed Site Driveway
- = Existing Cross-Access Connection
- = Proposed Site Parcel

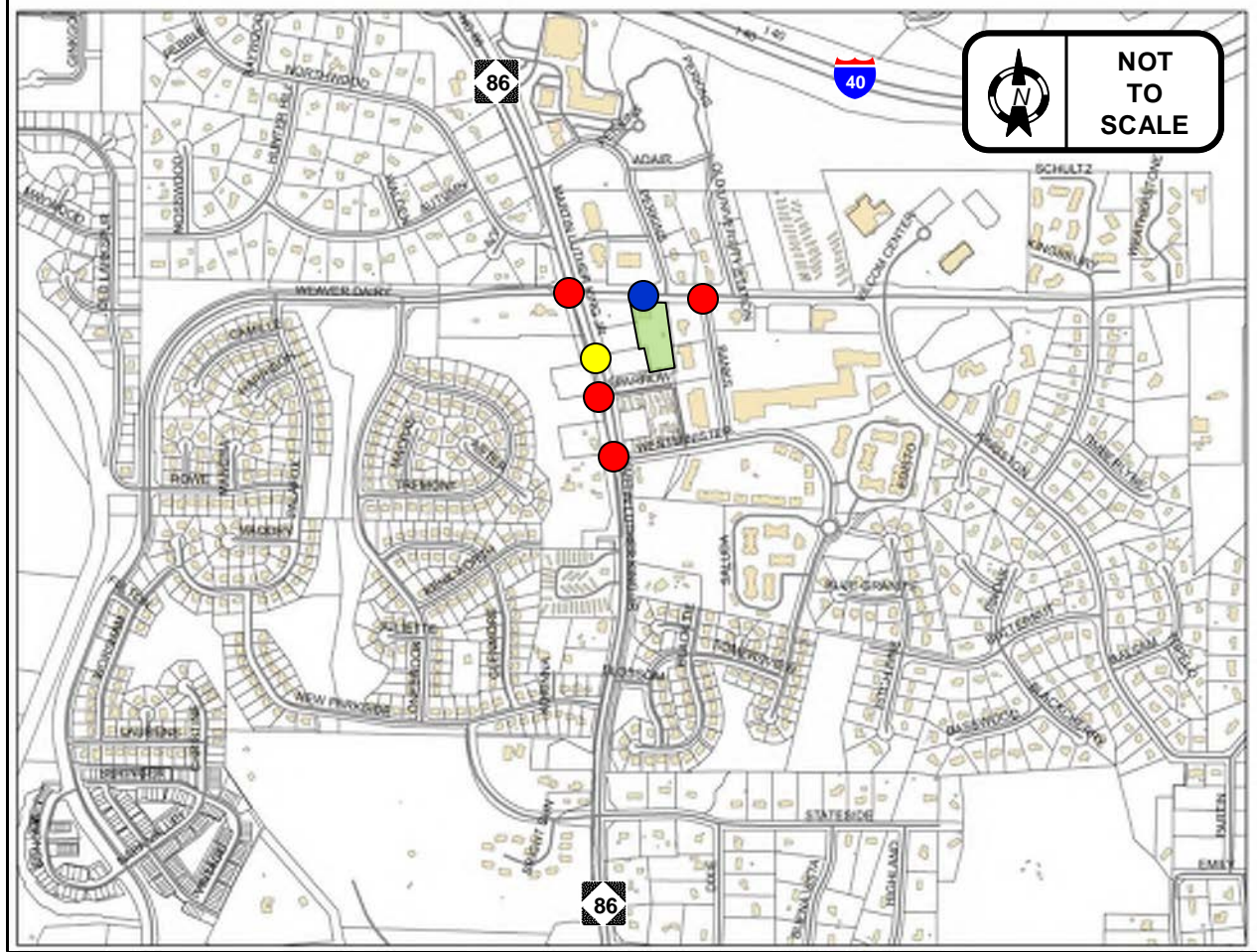

**1165 Weaver Dairy Rd Commercial Building
Traffic Impact Study - Update**

PROJECT STUDY AREA MAP

DATE: March 2018

FIGURE ES-1



**NOT
TO
SCALE**

**1165 Weaver Dairy Rd Commercial Building
Traffic Impact Study - Update**

PRELIMINARY SITE PLAN

DATE: March 2018

FIGURE ES-2

LEGEND

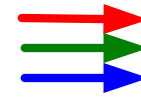

= PROPOSED SITE ACCESS LOCATIONS

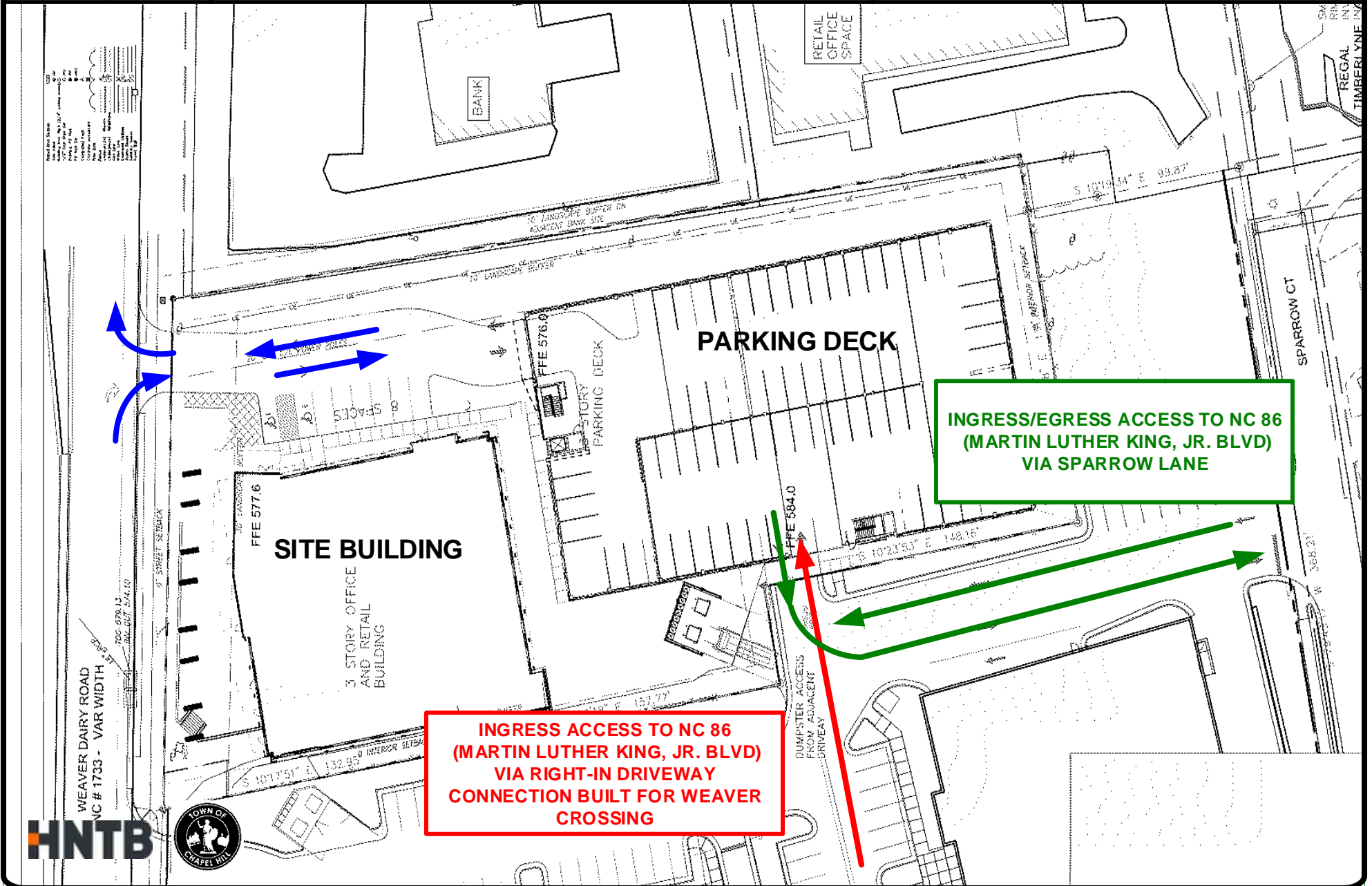

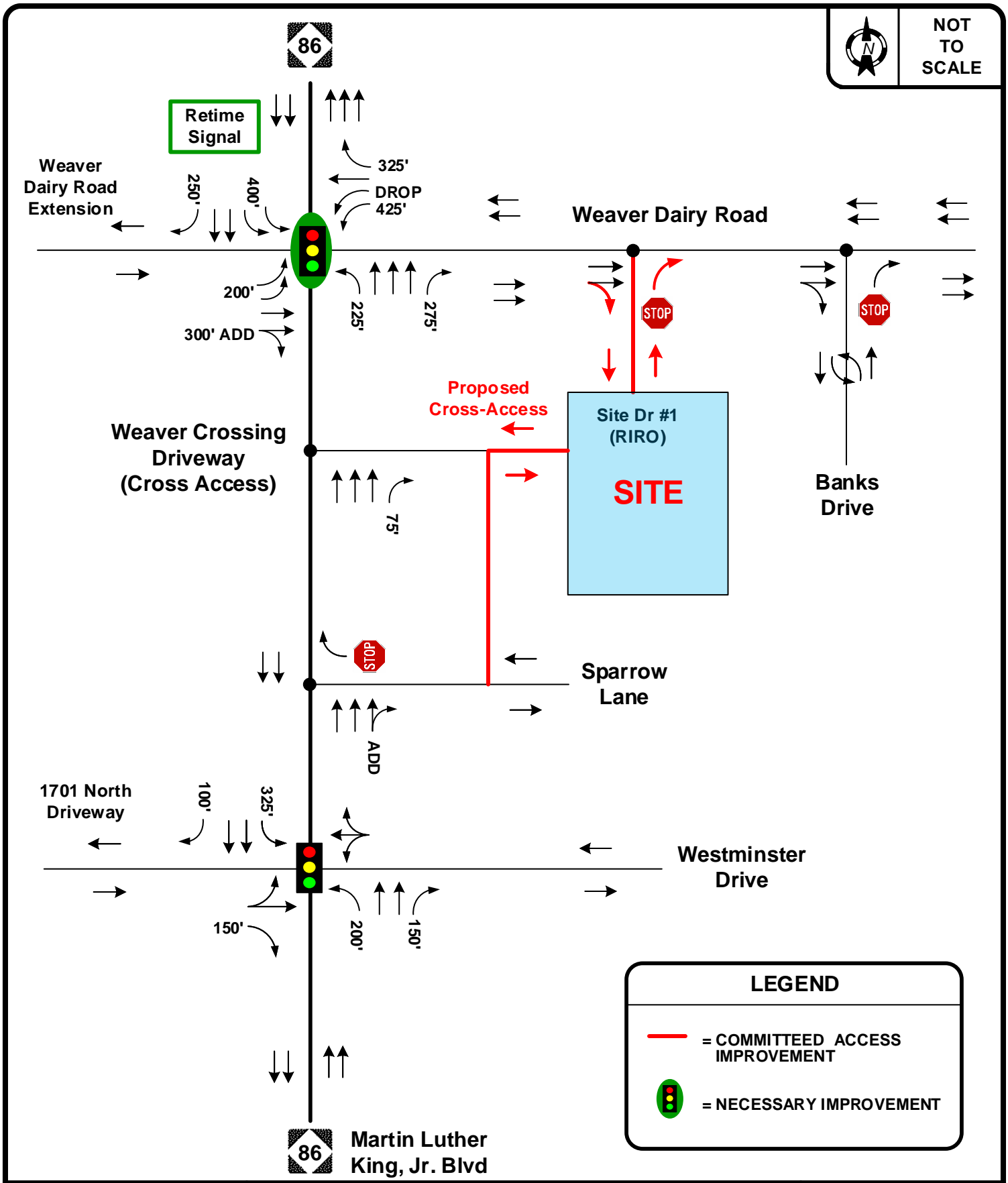

Weaver Dairy Rd

er Dairy Rd

1733

**WEAVER
CROSSING**

86

Martin Luther
King, Jr. Blvd

**Consider
Additional
Pedestrian
Signage**



**SITE
BUILDING**

**Proposed
Cross-
Access**

DUMPSTER
FROM ADJ
DRIVEWAY

3-STORY
PARKING DECK

N 79°44'16" E 1.38' OFFSET SETBACK

© 2016 Google



HNTB



**1165 Weaver Dairy Road Commercial Building
Traffic Impact Study - Update**

DATE: March 2018

RECOMMENDED IMPROVEMENTS DETAIL

FIGURE ES-4

11SIXTY5 WEAVER DAIRY ROAD

1165 WEAVER DAIRY ROAD, CHAPEL HILL, NC 27514

SPECIAL USE PERMIT

PROJECT DATA

PROPERTY ADDRESS	1165 WEAVER DAIRY ROAD	
PROPERTY OWNER	COMPROP LLC	
PIN	9880350595	
DEED REFERENCE	BOOK 6055 PAGE 580	
EXISTING USE	VACANT LAND	
PROPOSED USE	RETAIL, OFFICE, MEDICAL CLINIC	
USE GROUP	B, C	
LAND AREA	78,557 SF	
GROSS LAND AREA =	78,557 SF X 1.10 = 86,412 SF	
PROJECT AREA	1.91 ACRES	
ONSITE DISTURBED AREA	1.8 ACRES	
OFFSITE DISTURBED AREA	0.11 ACRES	
EXISTING ZONING	MU-01-1	
PROPOSED ZONING	O1-3	
PIN	9880350595	
FAR (O1-3)	.566	
MAXIMUM BUILDING SIZE	48,909 SF	
EXISTING BUILDING SIZE	0 SF (FORMER BUILDING ALREADY REMOVED)	
PROPOSED BUILDING SIZE	48,624 SF (EXCLUDING PARKING DECK)	
REQUIRED PARKING	NOT SPECIFIED IN O1-3 ZONE IN NON-TOWN CENTER ZONES REQUIRED PARKING WOULD BE: MINIMUM MAXIMUM	
	2,557 SF REST/RETAIL	9 34
	13,820 SF GEN BUSINESS/CLINIC	54 69
	32,247 SF OFFICE	92 129
	TOTAL SPACES	155 232
PROPOSED PARKING	1 PER 212 BUILT SF 1 H/C SURFACE SPACE 4 STANDARD SURFACE SPACES 10 H/C SPACES IN PARKING DECK + 216 STANDARD SPACES IN PARKING DECK 231 SPACES TOTAL PLUS MOPED AND MOTORCYCLE SPACES	
REQUIRED LOADING SPACES	2	
PROPOSED LOADING SPACE	1 FULL SIZE ON-SITE 1 IN PARKING DECK FOR BOX TRUCKS	
REQUIRED BICYCLE PARKING	NOT SPECIFIED IN O1-3 ZONE IN NON-TOWN CENTER ZONES THE MINIMUM BICYCLE PARKING WOULD BE 20 SPACES	
PROPOSED BICYCLE PARKING	24 TOTAL 2 SPACES (1 LOOP) IN ENTRY PLAZA 10 SPACES (5 LOOPS) IN OPEN PARKING DECK 12 SPACES (LOCKERS) LONG-TERM IN SECURED AREA IN PARKING DECK	

VICINITY MAP

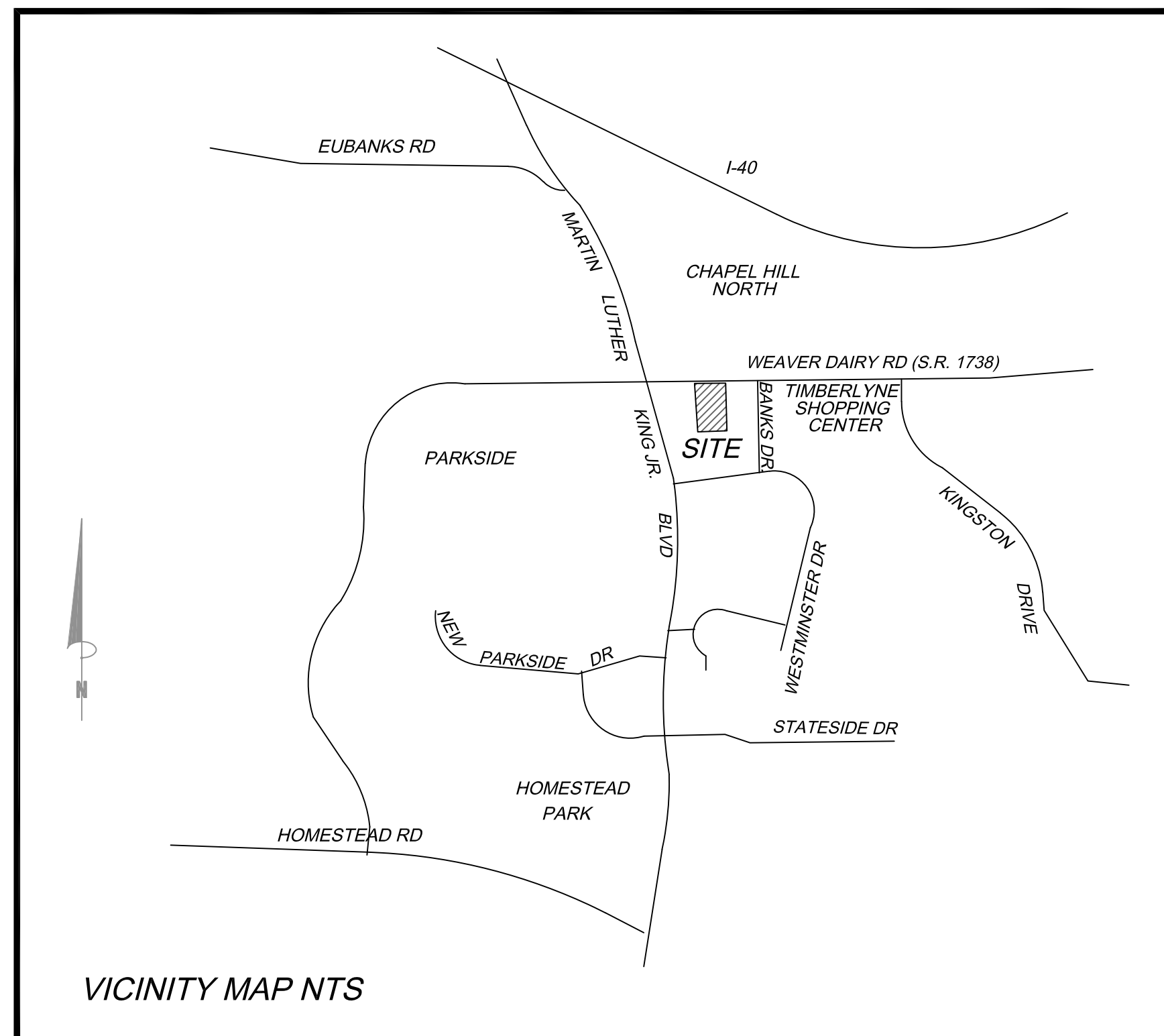

VICINITY MAP NTS

DESIGN TEAM

OWNER/DEVELOPER	COMPROP LLC 727 EASTOWN DRIVE, SUITE 300-D, CHAPEL HILL NC 27514 PETE SLOMIANYJ 919-949-1014
LANDSCAPE ARCHITECT	COULTER JEWELL THAMES PA 111 WEST MAIN STREET, DURHAM NC 27701 WENDI RAMSDEN 919-682-0368
CIVIL ENGINEER	COULTER JEWELL THAMES PA 111 WEST MAIN STREET, DURHAM NC 27701 VINCE CHRICHIELLA 919-682-0368
ARCHITECT	MHA WORKS 501 WASHINGTON STREET, SUITE G, DURHAM NC 27701 SCOTT LAPORTE 919-682-2870

PROJECT NOTES

GENERAL NOTES:

-
-
-
- CONSTRUCTION WASTE:
 - BY ORANGE COUNTY ORDINANCE, CLEAN WOOD WASTE, SCRAP METAL AND CORRUGATED CARDBOARD, ALL PRESENT IN CONSTRUCTION WASTE, MUST BE RECYCLED.
 - BY ORANGE COUNTY ORDINANCE, ALL HAULERS OF CONSTRUCTION WASTE MUST BE PROPERLY LICENSED.
 - PRIOR TO ANY DEMOLITION OR CONSTRUCTION ACTIVITY ON THE SITE THE APPLICANT WILL HOLD A PRE-DEMOLITION/PRE-CONSTRUCTION CONFERENCE WITH THE COUNTY'S SOLID WASTE STAFF. THIS MAY BE THE SAME MEETING HELD WITH OTHER DEVELOPMENT OFFICIALS.
 - BECAUSE THERE MAY BE REGULATED RECYCLABLE MATERIALS (METAL, WOOD, CARDBOARD) IN SOME OF THE DEMOLITION WORK IN EXCESS OF 500 SQUARE FEET (EXISTING BUILDING) AS WELL AS IN THE NEW CONSTRUCTION OF THE PROPOSED FACILITY, THE APPLICANT WILL NEED TO CONTACT SOLID WASTE MANAGEMENT STAFF TO CONDUCT A PRE-DEMOLITION ASSESSMENT BEFORE BEGINNING WORK. IN ADDITION, THE APPLICANT WILL BE REQUIRED TO OBTAIN A REGULATED RECYCLABLE MATERIALS PERMIT FROM THE TOWN OF CHAPEL HILL.

FIRE PROTECTION:

- ADDRESS NUMBERS MUST BE 4" TALL WITHIN 25' OF WEAVER DAIRY ROAD AND 8" TALL IF 26'-50' FROM THE STREET. ADDRESS NUMBERS MUST BE CLEARLY VISIBLE FROM THE STREET AND OF CONTRASTING COLOR TO THEIR BACKGROUND.

SOLID WASTE:

- TOWN OF CHAPEL HILL TRASH COLLECTION IS DONE ONE TIME PER WEEK. IF BUILDING OPERATIONS PRODUCE MORE TRASH THAN CAN BE ACCOMMODATED IN THE DUMPSTER FACILITY, THE OWNER WILL BE REQUIRED TO CONTRACT WITH A PRIVATE COLLECTION COMPANY WHO CAN ACCOMMODATE MORE FREQUENT PICKUP.

TRAFFIC ENGINEERING:

- A LANE OR SIDEWALK CLOSURE PERMIT MUST BE OBTAINED FROM THE TOWN'S PUBLIC WORKS DEPARTMENT AT LEAST 5 BUSINESS DAYS PRIOR TO CLOSURE.

LIST OF SHEETS

C-0	COVER SHEET
C-0.1	AREA MAP
C-1.0	EXISTING CONDITIONS, DEMOLITION AND TREE PROTECTION PLAN, AND SITE ANALYSIS
C-1.1	CONSTRUCTION MANAGEMENT PLAN
C-2.0	SITE PLAN
C-2.1	PEDESTRIAN CONNECTIVITY PLAN
C-3.0	GRADING AND STORMWATER PLAN
C-4.0	NOT USED (reserved for Erosion Control Plan)
C-5.0	UTILITY PLAN
C-6.0	NOT USED (reserved for Lighting Plan)
C-7.0	SITE DETAILS
L-1.0	LANDSCAPE AND TREE COVERAGE PLAN
A101D	FLOOR PLAN PARKING LEVELS 1 & 2
A200	BUILDING ELEVATIONS
A201	BUILDING ELEVATIONS
A203	PARKING DECK ELEVATIONS
A204	PARKING DECK ELEVATIONS
A205	COMPOSITE EAST + WEST ELEVATIONS



Coulter
Jewell
Thames, PA

111 West Main Street
Durham, N.C. 27701
p 919.682.0368
f 919.688.5646
www.cjtpa.com

NC BOARD OF EXAMINERS FOR
ENGINEERS AND SURVEYORS
LIC # C-1209
NC BOARD OF LANDSCAPE
ARCHITECTS LIC # C-104

MHAworks
ARCHITECTURE
PLANNING
INTERIORS

501 WASHINGTON STREET, SUITE G
DURHAM, NORTH CAROLINA, 27701
P 919.682.2870
F 919.682.2569
www.mhaworks.com

AIA 2030 Commitment | SUSTAINABILITY

Project:

11SIXTY5
Weaver Dairy
Road

1165 Weaver Dairy Rd.
Chapel Hill, NC 27514

PIN:
9880350595



NOT ISSUED FOR
CONSTRUCTION

Job Number: 1529

Drawn	WLR, MTC, VJC
Checked	WLR, VJC
Date	11-30-17
Revisions	1-25-18 TRT COMMENT REVISIONS 2-22-18 TOWN COMMENT REVISIONS

SPECIAL USE PERMIT

Sheet Title:

COVER SHEET

Sheet Number

C-0

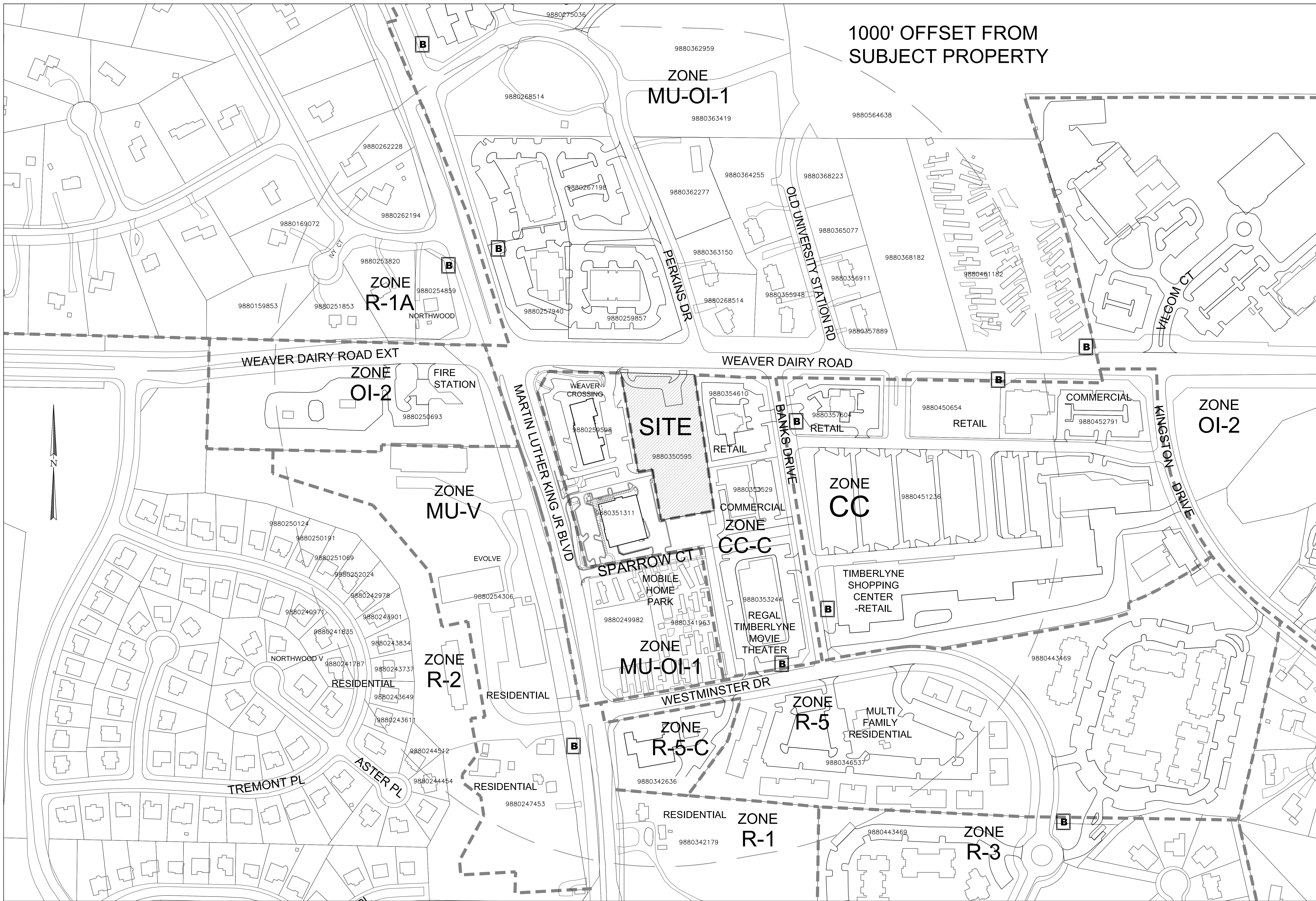

1000' OFFSET FROM
SUBJECT PROPERTY

ZONE
MU-OI-1

ZONE
R-1A
NORTHWOOD

ZONE
OI-2

ZONE
MU-V

ZONE
MU-OI-1

ZONE
R-2

ZONE
R-5-C

ZONE
CC

COMMERCIAL
ZONE
CC-C

ZONE
OI-2

ZONE
R-5

ZONE
R-1

ZONE
R-3



**Coulter
Jewell
Thames**
P.A.

111 West Main Street
Durham, N.C. 27701
p 919.682.0368
f 919.688.5646
www.cjtpa.com

NC BOARD OF EXAMINERS FOR
ENGINEERS AND SURVEYORS
LIC # C-1209
NC BOARD OF LANDSCAPE
ARCHITECTS LIC # C-104

MHA works
PLANNING ARCHITECTURE INTERIORS
501 WASHINGTON STREET, SUITE G
DURHAM, NORTH CAROLINA, 27701
p 919.682.2870
f 919.682.2569
www.mhaworks.com

AIA 2030 Commitment SUSTAINABILITY

Project:
**11SIXTY5
Weaver Dairy
Road**

1165 Weaver Dairy Rd.
Chapel Hill, NC 27514

PIN:
9880350595



NOT ISSUED FOR
CONSTRUCTION

Job Number: 1529

Drawn	WLR, MTC, VJC
Checked	WLR, VJC
Date	11-30-17
Revisions	1-25-18
	TRT COMMENT REVISIONS
	2-22-18
	TOWN COMMENT REVISIONS

SPECIAL USE PERMIT

Sheet Title:

**AREA
MAP**

Sheet Number

C-0.1

1
C-0.1
AREA MAP
1" = 120'-0"





1 EXISTING CONDITIONS
C-1.0
1" = 30'

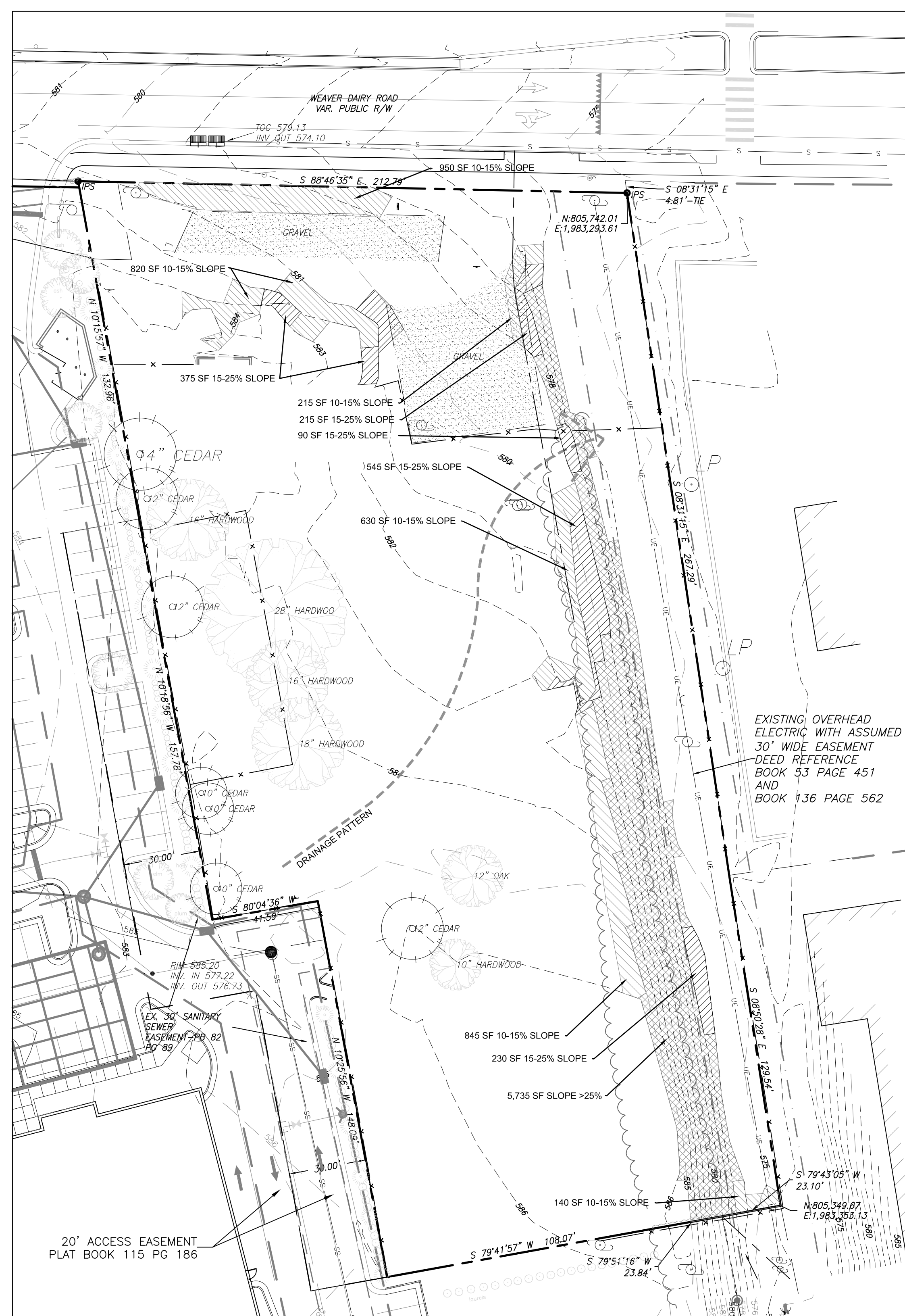

2 SITE ANALYSIS
C-1.0
1" = 30'

GENERAL:
THE SITE IS CURRENTLY VACANT WITH FEW SPECIMEN TREES. THERE IS A 40' WIDE ELECTRIC POWER EASEMENT ALONG THE EASTERN PROPERTY LINE.

HYDROLOGICAL FEATURES/DRAINAGE
THERE ARE NO WATER FEATURES ON THE SITE. THE SITE SITS ON HIGH GROUND AND GENERALLY DRAINS FROM SOUTHWEST TO NORTHEAST.

SOIL TYPES
THE USDA / NRCS WEB SOIL SURVEY CLASSIFIES TWO SOILS ON THIS SITE. THE NORTHERN HALF OF THE SITE IS Hrc, A HERDON SILT LOAM WITH 6%-10% SLOPES. THE SOUTH HALF OF THE SITE IS GcB A GEORGEVILLE SILT LOAM WITH 2%-6% SLOPES.

FEMA FLOODPLAIN INFORMATION.
THERE IS NO MAPPED FLOODPLAIN ON SITE. FEMA PANEL 9880.

TOPOGRAPHY/SLOPES:
EIGHTY PERCENT OF THE SITE IS FAIRLY FLAT, WITH AN AVERAGE SLOPE OF ABOUT 3%. THE NORTH PORTION OF THE SITE IS A LITTLE STEEPER AT ABOUT 5-6% SLOPE, AND THE BACK OF THE SITE HAS A FLATTER 2-3% SLOPE.

THE SITE SLOPES FROM SOUTHWEST TO NORTHEAST, AND DROPS APPROXIMATELY 11 FEET OVER THE LENGTH OF THE PARCEL. THE DEVELOPMENT WILL TAKE ADVANTAGE OF THIS DROP BY SETTING PARKING DECK LEVELS TO ACCESS WEAVER DAIRY ROAD GRADES, AND A DIFFERENT ACCESS POINT TO THE ADJACENT WEAVER CROSSING DEVELOPMENT.

THERE ARE STEEP SLOPES ON THE SITE WITHIN THE ELECTRIC EASEMENT. THESE APPEAR TO HAVE BEEN CREATED WHEN THE SITE WAS LEVELED TO BUILD THE FORMER SCHOOL AND / OR EXISTING SHOPPING PLAZA.

EXISTING SLOPES:
10-15% = 3,600 SF (4.6% OF THE SITE)
15-25% = 1,365 SF (1.7% OF THE SITE)
>25% = 5,735 SF (7.3% OF THE SITE)
86.4% OF THE SITE HAS <10% SLOPE

EXISTING STEEP SLOPES
>25% SF TO BE REMOVED:
5,735 SF - 100%

SUN/SHADE PATTERNS
THE SUN WILL PASS AROUND THE BACK SIDE OF THE BUILDING AND PARKING STRUCTURE DURING THE COURSE OF THE DAY. THE RETAIL ENTRIES AND THE PLAZA ON THE NORTH SIDE WILL BE IN THE SHADE MOST OF THE DAY. THE OFFICE AND CLINIC ENTRIES ON THE EAST WILL GET THE MORNING SUN. THEY WILL HAVE CANOPIES TO PROTECT PEDESTRIANS FROM SUN AND RAIN. TREES WILL BE ADDED TO THE EAST AND WEST BUILDING FACADE AREAS, AS WELL AS THROUGHOUT THE PEDESTRIAN PLAZA AND ALONG THE SOUTH SIDE OF THE PUBLIC SIDEWALK ON WEAVER DAIRY ROAD.

THE MAJORITY OF PARKING WILL BE IN A DECK. THE FEW SURFACE PARKING SPACES WILL BE SHADED MUCH OF THE DAY BY THE PARKING DECK, AND FROM THE HOT WEST AFTERNOON SUN BY THE BUILDING.



Coulter Jewell Thames
ENGINEERING, PLANNING, LANDSCAPE ARCHITECTURE

111 West Main Street
Durham, N.C. 27701
p 919.682.0368
f 919.688.5646
www.cjtpa.com

NC BOARD OF EXAMINERS FOR ENGINEERS AND SURVEYORS
LIC # C-1209
NC BOARD OF LANDSCAPE ARCHITECTS LIC # C-104

MHAworks
PLANNING ARCHITECTURE INTERIORS
DURHAM GREENVILLE
501 WASHINGTON STREET SUITE G
DURHAM NORTH CAROLINA 27701
p 919.682.8790
f 919.682.5569
www.mhaworks.com
AIA 2030 Commitment SUSTAINABILITY

Project:

11SIXTY5
Weaver Dairy Road

1165 Weaver Dairy Rd.
Chapel Hill, NC 27514

PIN:
9880350595



NOT ISSUED FOR CONSTRUCTION

Job Number: 1529

Drawn	WLR, MTC, VJC
Checked	WLR, VJC
Date	11-30-17
Revisions	1-25-18
	TRT COMMENT REVISIONS
	2-22-18
	TOWN COMMENT REVISIONS

SPECIAL USE PERMIT

Sheet Title:

EXISTING CONDITIONS and SITE ANALYSIS

Sheet Number

C-1.0

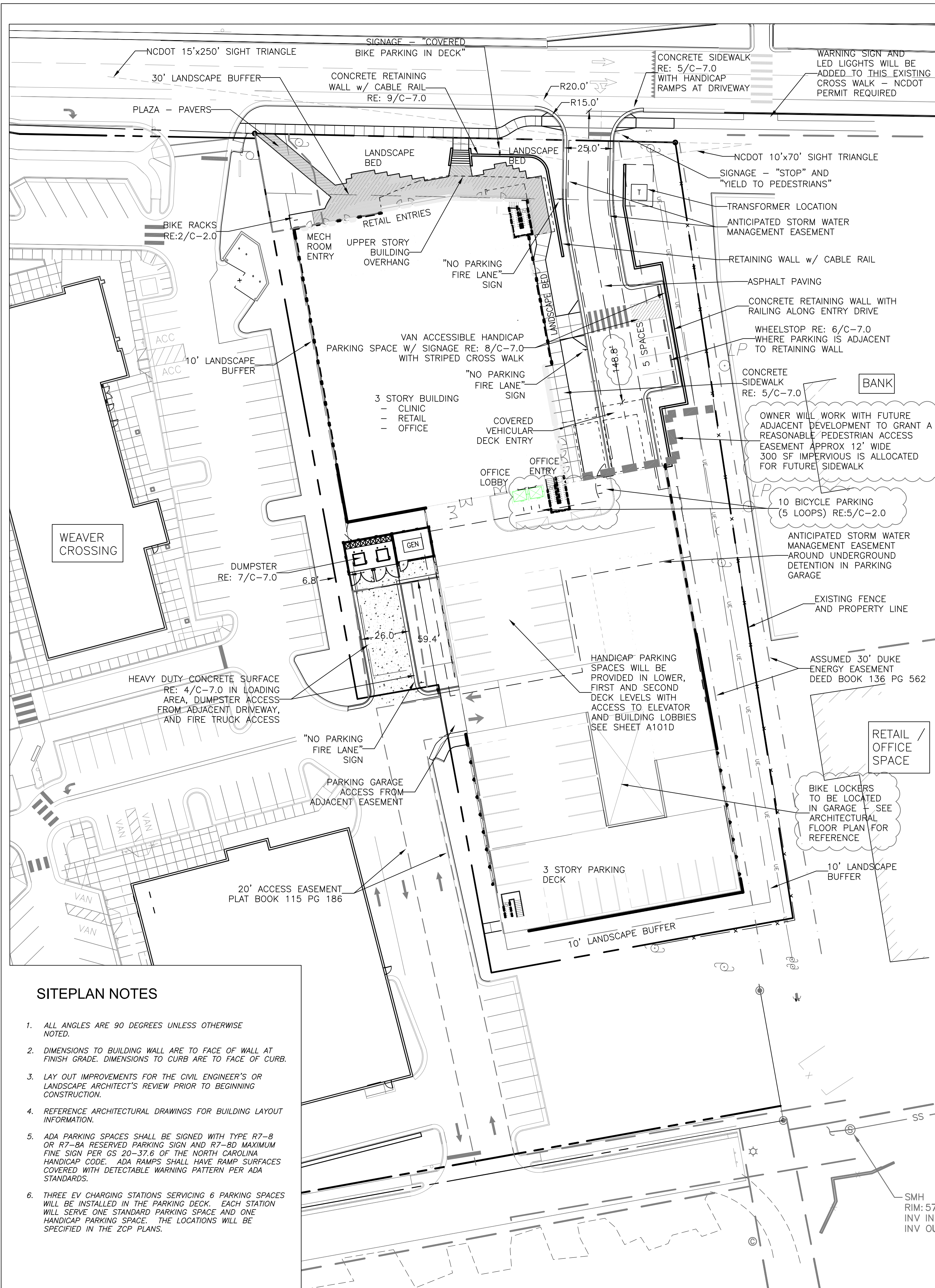

SITEPLAN NOTES

- ALL ANGLES ARE 90 DEGREES UNLESS OTHERWISE NOTED.
- DIMENSIONS TO BUILDING WALL ARE TO FACE OF WALL AT FINISH GRADE. DIMENSIONS TO CURB ARE TO FACE OF CURB.
- LAY OUT IMPROVEMENTS FOR THE CIVIL ENGINEER'S OR LANDSCAPE ARCHITECT'S REVIEW PRIOR TO BEGINNING CONSTRUCTION.
- REFERENCE ARCHITECTURAL DRAWINGS FOR BUILDING LAYOUT INFORMATION.
- ADA PARKING SPACES SHALL BE SIGNED WITH TYPE R7-B OR R7-8A RESERVED PARKING SIGN AND R7-8D MAXIMUM FINE SIGN PER GS 20-37.6 OF THE NORTH CAROLINA HANDICAP CODE. ADA RAMPS SHALL HAVE RAMP SURFACES COVERED WITH DETECTABLE WARNING PATTERN PER ADA STANDARDS.
- THREE EV CHARGING STATIONS SERVING 6 PARKING SPACES WILL BE INSTALLED IN THE PARKING DECK. EACH STATION WILL SERVE ONE STANDARD PARKING SPACE AND ONE HANDICAP PARKING SPACE. THE LOCATIONS WILL BE SPECIFIED IN THE ZCP PLANS.

1 SITE PLAN
C-2.0 1" = 30'



TRUCK TURN RADIUS SCALE: 1" = 30'

- NOTES:
- INSTALLATION TO BE COMPLETED IN ACCORDANCE WITH MANUFACTURER'S SPECIFICATIONS.
 - DO NOT SCALE DRAWINGS.

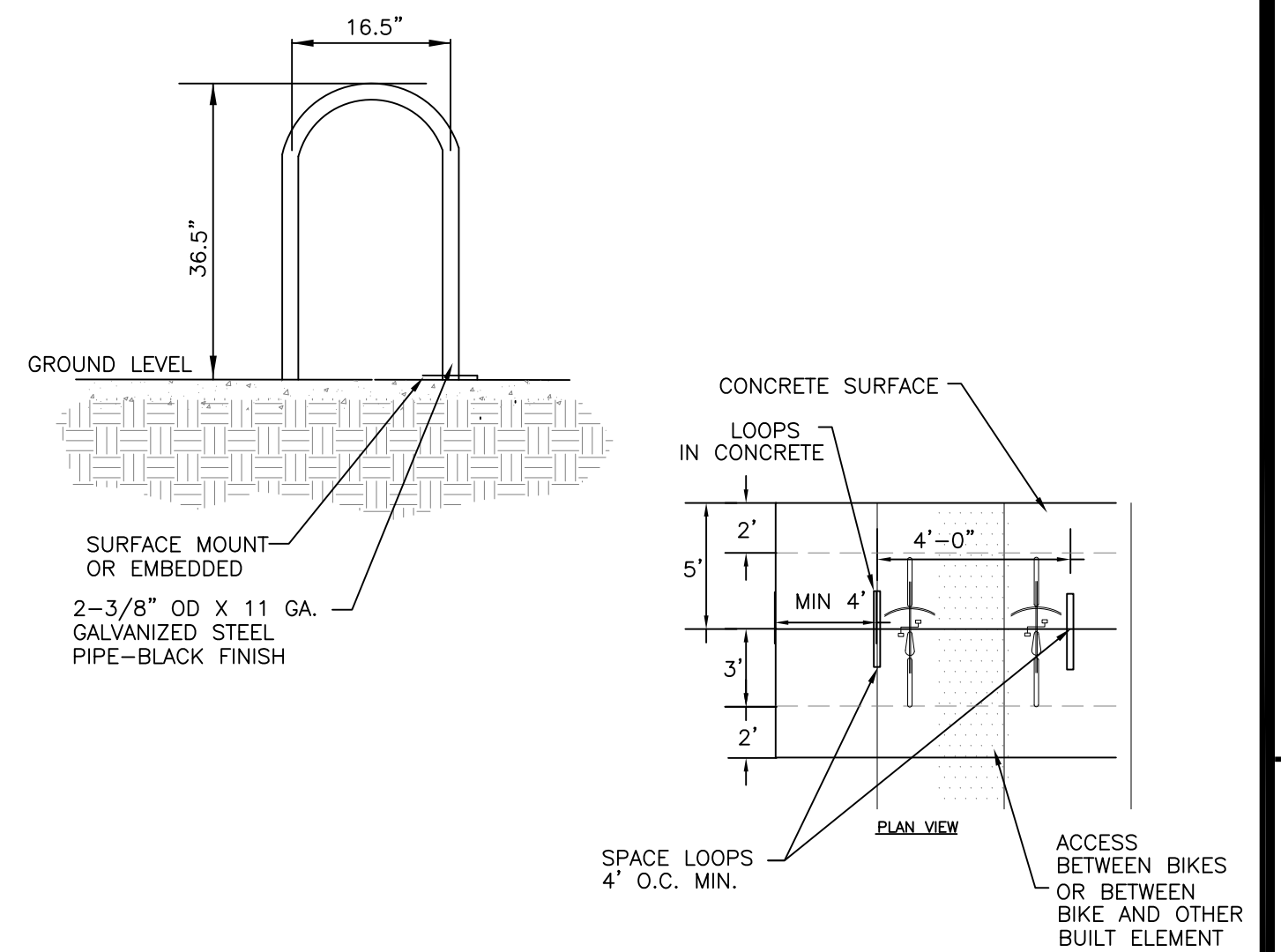

2 BICYCLE RACK
C-2.0 NTS

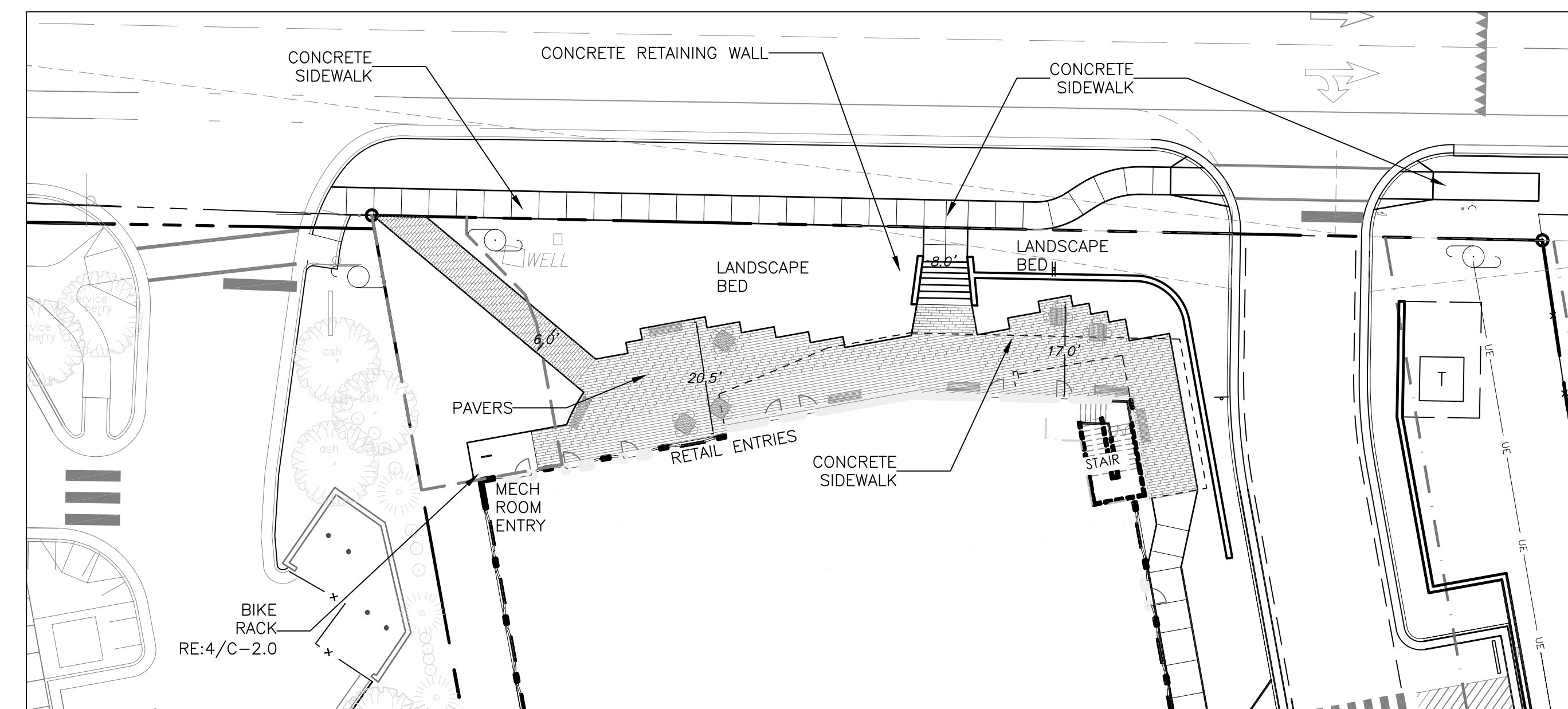

3 PLAZA DETAIL PLAN
C-2.0 1" = 20'

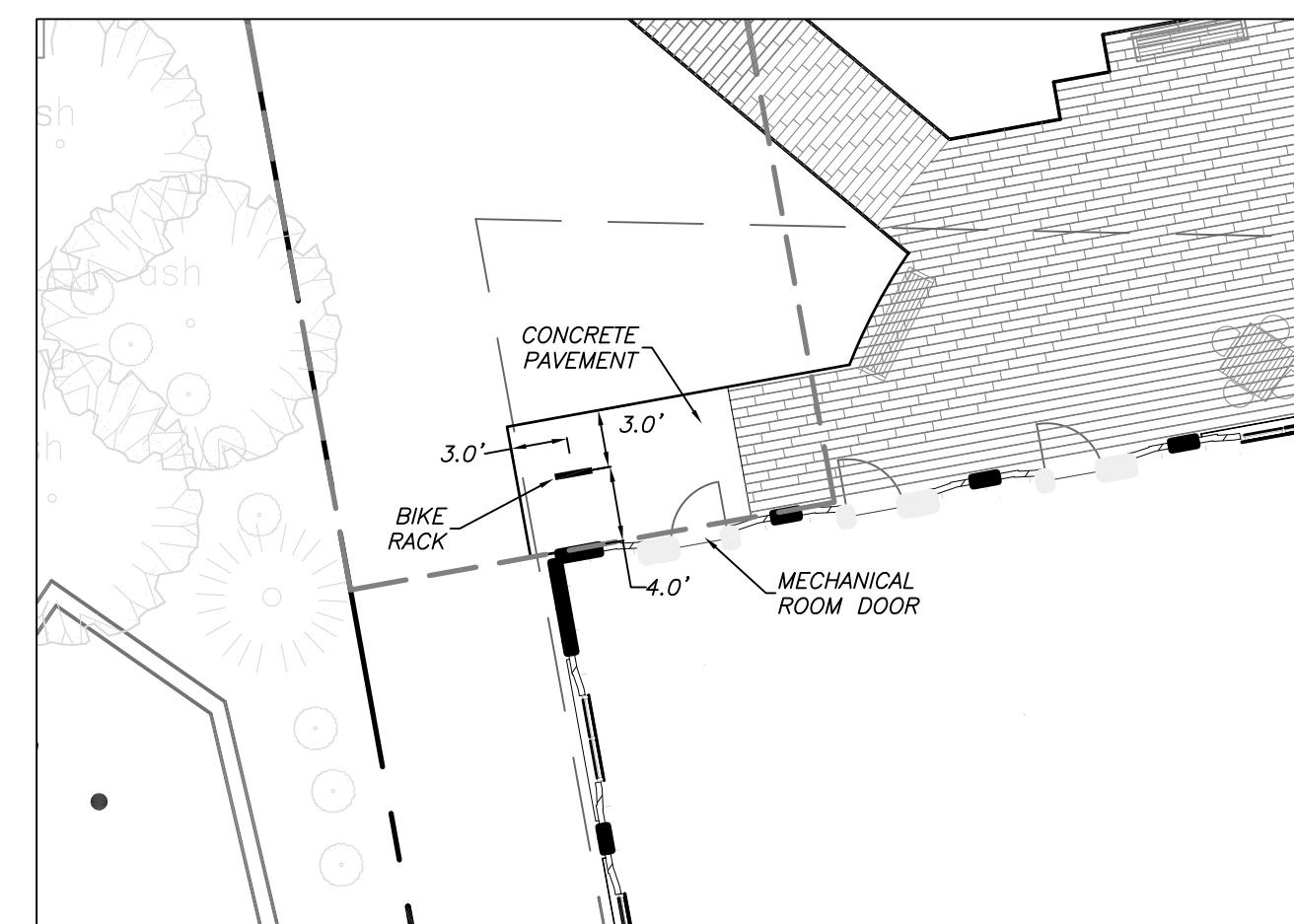

4 DIMENSIONS - SHORT TERM BIKE RACKS
C-2.0 1" = 10'

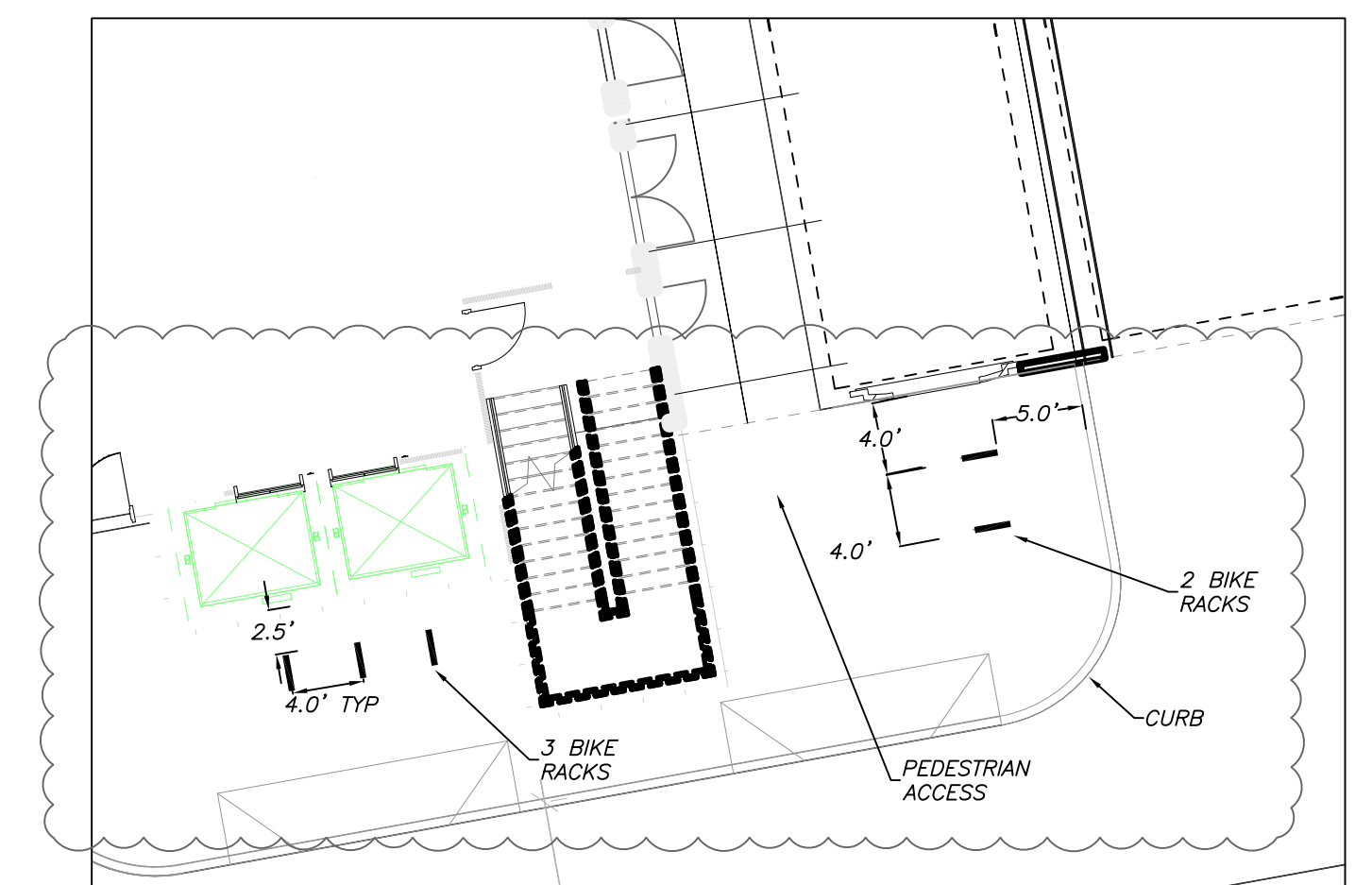

5 DIMENSIONS - SHORT TERM BIKE PARKING - DECK
C-2.0 1" = 10'

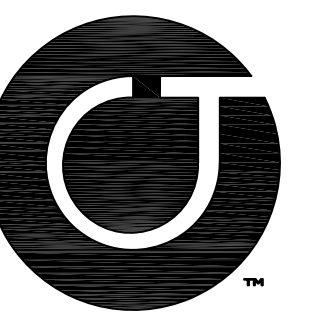

Coulter Jewell Thames P.A.

111 West Main Street
Durham, N.C. 27701
p 919.682.0368
f 919.688.5646
www.cjtpa.com

NC BOARD OF EXAMINERS FOR ENGINEERS AND SURVEYORS
LIC # C-1209
NC BOARD OF LANDSCAPE ARCHITECTS
LIC # C-104

MHAworks
PLANNING ARCHITECTURE INTERIORS
501 WASHINGTON STREET, SUITE G
DURHAM, NORTH CAROLINA, 27701
p 919.682.2870
f 919.682.2569
www.mhaworks.com

Project:

11SIXTY5
Weaver Dairy Road

1165 Weaver Dairy Rd.
Chapel Hill, NC 27514

PIN:
9880350595



NOT ISSUED FOR CONSTRUCTION

Job Number: 1529

Drawn	WLR, MTC, VJC
Checked	WLR, VJC
Date	11-30-17
Revisions	1-25-18 TRT COMMENT REVISIONS 2-22-18 TOWN COMMENT REVISIONS

SPECIAL USE PERMIT

Sheet Title:

SITE PLAN

Sheet Number

C-2.0

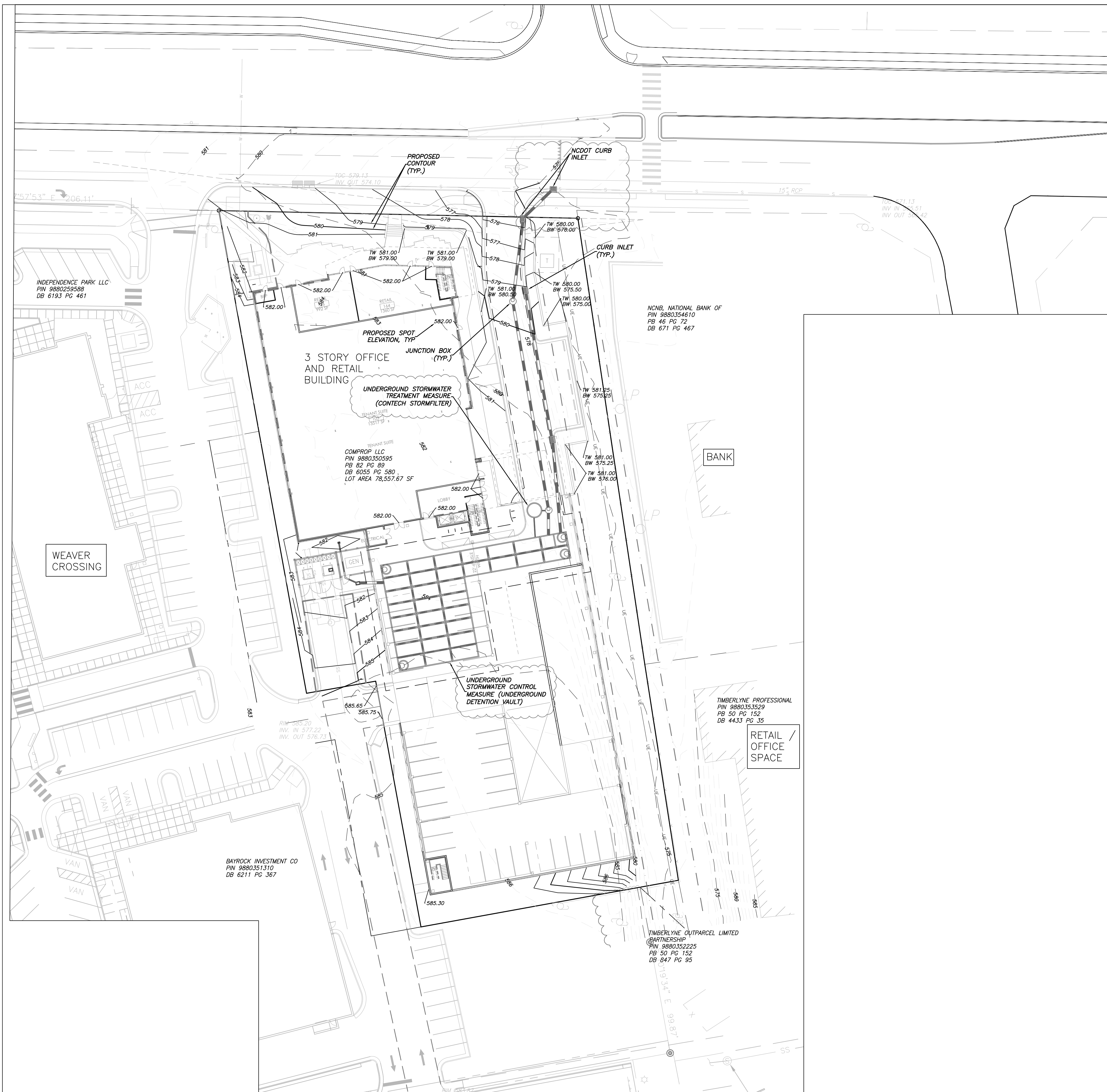

storm drainage notes

1. PARKING GARAGE DRAINAGE:
 - A. DRAINAGE FROM THE TOP LEVEL SHALL DRAIN TO THE STORMWATER CONTROL MEASURE.
 - B. ALL OTHER DRAINAGE SHALL DRAIN TO SANITARY SEWER.
 - C. PARKING GARAGE DRAINAGE PLANS WILL BE PROVIDED AT ZCP.
2. BUILDING DRAINAGE:
 - A. ALL BUILDING ROOF DRAINAGE SHALL DRAIN TO THE STORMWATER CONTROL MEASURE.
 - B. BUILDING ROOF DRAINAGE PLANS WILL BE PROVIDED AT ZCP.
3. PRIOR TO ISSUANCE OF ZCP, A GEOTECHNICAL ENGINEERING REPORT SHALL BE PROVIDED INDICATING THE ELEVATION OF THE SEASONAL HIGH WATER TABLE WITHIN THE AREA OF THE PROPOSED STORMWATER CONTROL MEASURE.

1
C-3.0
GRADING AND DRAINAGE PLAN
1" = 30'

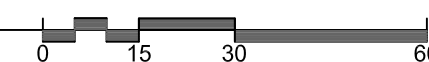

**Coulter
Jewell
Thames** PA

111 West Main Street
Durham, N.C. 27701
p 919.682.0368
f 919.688.5646
www.cjtpa.com

NC BOARD OF EXAMINERS FOR
ENGINEERS AND SURVEYORS
LIC # C-1209
NC BOARD OF LANDSCAPE
ARCHITECTS LIC # C-104

MHA works
PLANNING ARCHITECTURE INTERIORS
-DURHAM
-GREENVILLE
501 WASHINGTON STREET, SUITE G
DURHAM, NORTH CAROLINA 27701
p 919.682.5369
www.mhaworks.com
SUSTAINABILITY
All 2030 Commitment

Project:
**11SIXTY5
Weaver Dairy
Road**

1165 Weaver Dairy Rd.
Chapel Hill, NC 27514

PIN:
9880350595

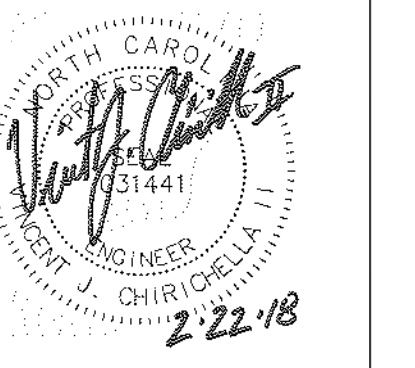

NOT ISSUED FOR
CONSTRUCTION

Job Number: 1529

Drawn	WLR, MTC, VJC
Checked	WLR, VJC
Date	11-30-17
Revisions	1-25-18 TRT COMMENT REVISIONS 2-22-18 TOWN COMMENT REVISIONS

SPECIAL USE PERMIT

Sheet Title:

**GRADING
PLAN**

Sheet Number
C-3.0

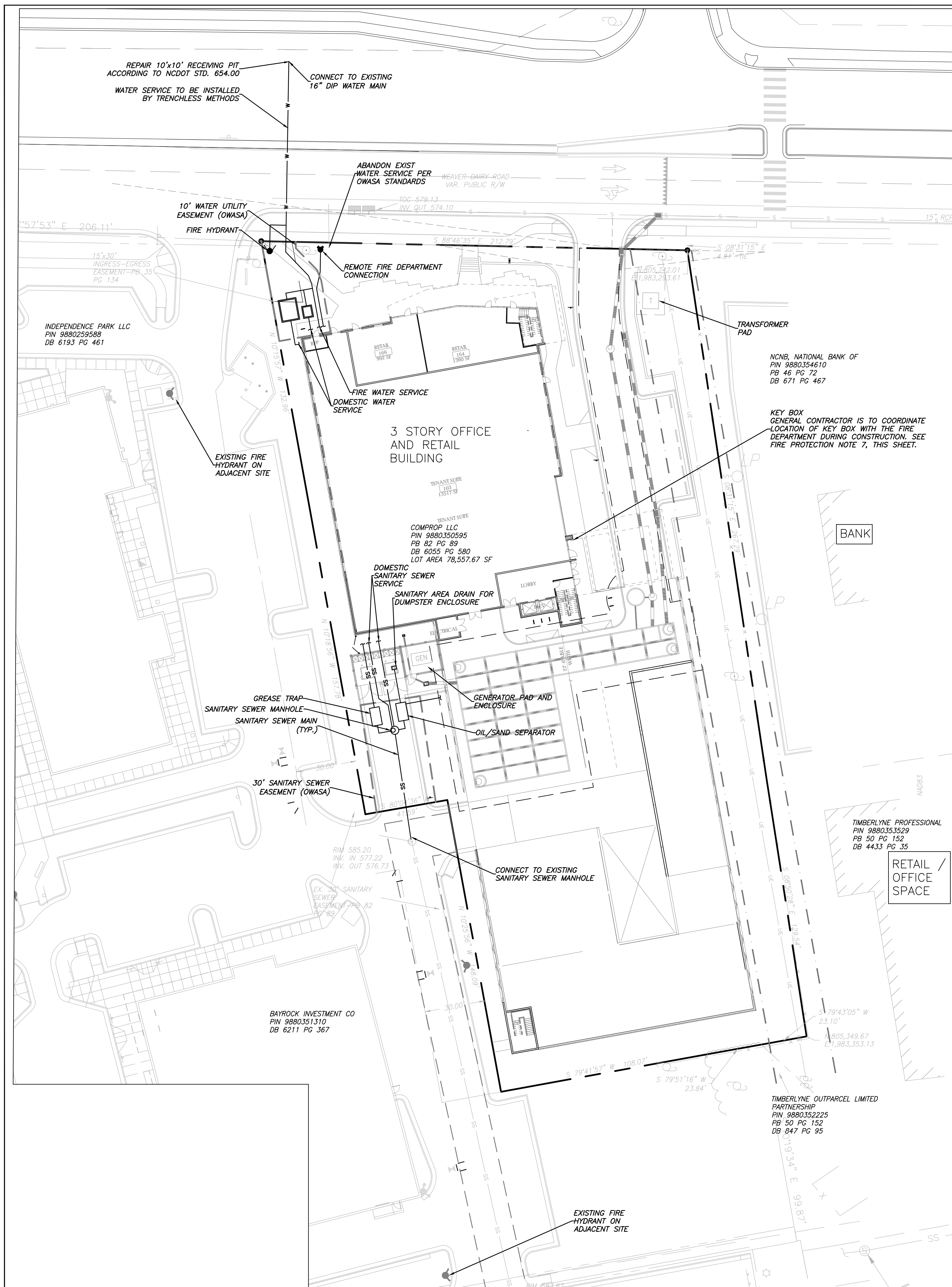

1 UTILITY PLAN
C-5.0
1" = 30'

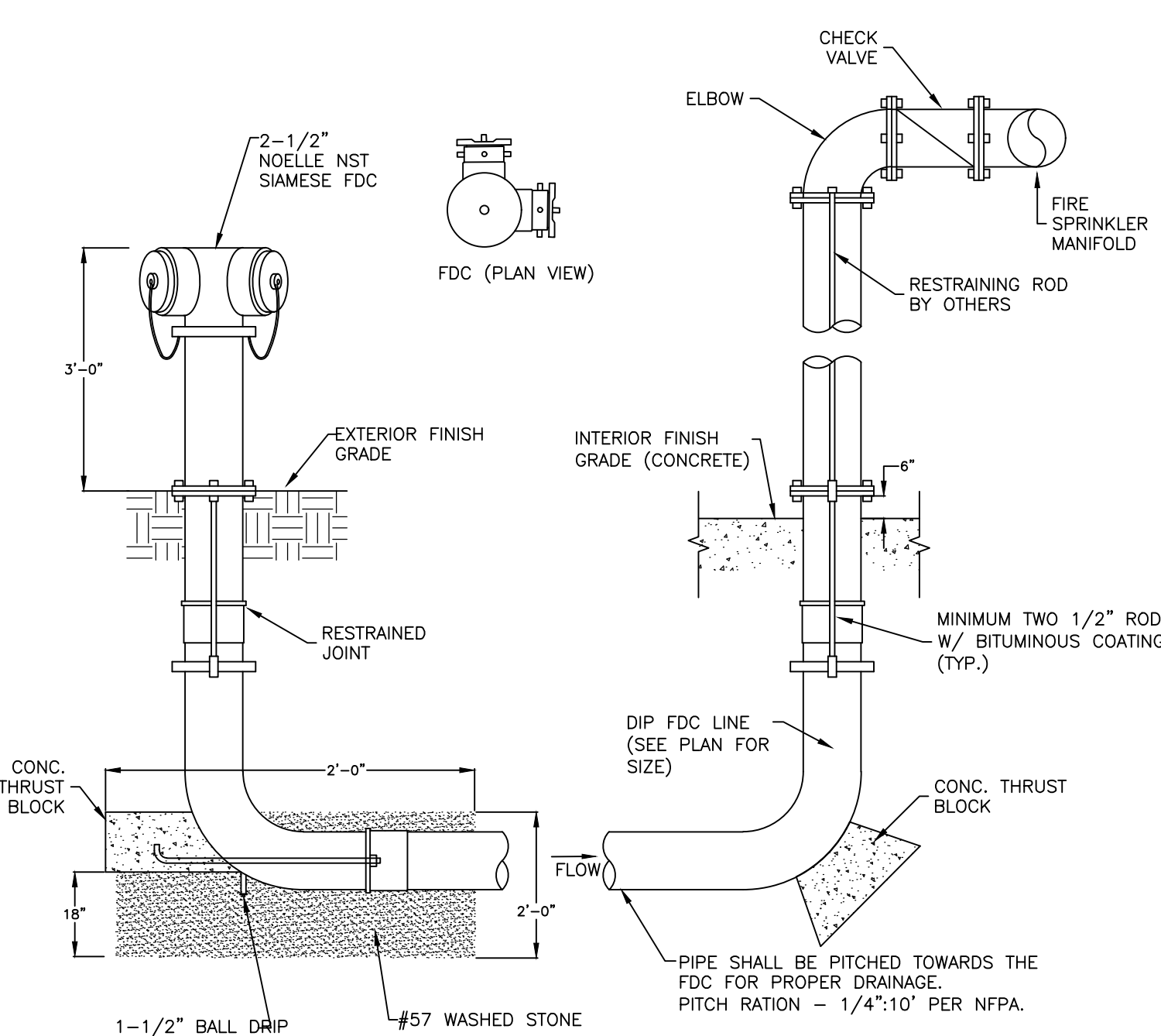

THE LOW POINT DRAIN SHALL BE CORROSION RESISTANT AND INSTALLED IN ACCORDANCE WITH THE MANUFACTURERS INSTRUCTIONS. THE DRAIN ARRANGEMENT SHALL BE SUBMITTED AS PART OF THE SITE PLAN UTILITY DETAIL AND APPROVED BY FIRE PREVENTION AND ENGINEERING. A DRAINAGE PIT TWO FEET IN DIAMETER SHALL BE EXCAVATED BELOW EACH DRAIN AND FILLED COMPLETELY WITH CRUSHED STONE MIXED WITH COURSE SAND UNDER AND AROUND THE DRAIN TO A LEVEL 6 INCHES ABOVE THE DRAIN. PITS SHALL NEITHER BE CONNECTED TO A STORM OR SANITARY SEWER NOR LOCATED WITHIN THE RIGHT-OF-WAY OR ANY EASEMENT AREA.

1 REMOTE FIRE DEPARTMENT CONNECTION (FDC)
C-5.0 N.T.S.

utility notes

GENERAL NOTES:

- CONTRACTOR SHALL NOTIFY "NORTH CAROLINA ONE CALL" (1-800-632-4949) AT LEAST 48 HOURS PRIOR TO BEGINNING CONSTRUCTION OR EXCAVATION TO HAVE EXISTING UTILITIES LOCATED. CONTRACTOR TO CONTACT ANY LOCAL UTILITIES THAT PROVIDE THEIR OWN LOCATOR SERVICE INDEPENDENT OF "NORTH CAROLINA ONE CALL".
- ALL WATER AND SEWER MAINS WITHIN PUBLIC EASEMENTS AND RIGHT-OF-WAYS TO BE OWNED, OPERATED AND MAINTAINED BY THE TOWN OF CHAPEL HILL.
- ALL CONSTRUCTION SHALL BE IN ACCORDANCE WITH THE TOWN OF CHAPEL HILL STANDARDS AND SPECIFICATIONS.
- ALL EXISTING UNDERGROUND UTILITIES ARE APPROXIMATELY LOCATED. ACTUAL LOCATION AND DEPTH SHALL BE CONFIRMED IN THE FIELD PRIOR TO CONSTRUCTION.
- BEFORE STARTING ANY CONSTRUCTION OF IMPROVEMENTS WITHIN ANY TOWN OR N.C.D.O.T. STREET OR HIGHWAY RIGHT-OF-WAY THE FOLLOWING PROCEDURES SHOULD BE UNDERTAKEN:
 - TOWN RIGHT-OF-WAY: CONTACT LOCAL AUTHORITIES' TRAFFIC ENGINEERING DEPT. FOR INFORMATION ON DETOURS, OPEN CUTTING OF STREETS OR FOR ANY CONSTRUCTION WITHIN RIGHT-OF-WAY.
 - N.C.D.O.T. RIGHT-OF-WAY: CONTACT PROJECT ENGINEERS AND OBTAIN ALL PERMITS AND ENCROACHMENTS (KEEP COPIES ON CONSTRUCTION SITE, ALSO CONTACT N.C.D.O.T. DISTRICT OFFICE 24 HOURS IN ADVANCE BEFORE PLACING CURB AND GUTTER).
- ALL DIMENSIONS AND GRADES SHOWN ON THE PLANS SHALL BE FIELD VERIFIED BY THE CONTRACTOR PRIOR TO CONSTRUCTION. CONTRACTOR SHALL NOTIFY THE OWNER IF ANY DISCREPANCIES EXIST. PRIOR TO PROCEEDING WITH CONSTRUCTION FOR NECESSARY PLAN OR GRADING CHANGES. NO EXTRA COMPENSATION SHALL BE PAID TO THE CONTRACTOR FOR ANY WORK DONE DUE TO DIMENSIONS OR GRADES SHOWN INCORRECTLY ON THESE PLANS IF SUCH NOTIFICATION HAS NOT BEEN GIVEN.
- POWER, TELEPHONE, AND GAS SERVICES TO BUILDINGS SHALL BE UNDERGROUND. ACCESS AND SERVICE ROUTES TO BE COORDINATED WITH THE PUBLIC UTILITIES, CONTRACTOR AND THE OWNER.
- RESURFACING OF STREET DUE TO UTILITY CUTS SHALL BE REQUIRED AT THE DIRECTION OF ENGINEERING. (MINIMUM 50' TO EITHER SIDE OF UTILITY CUTS).

SANITARY SEWER:

- MINIMUM COVER OF 5 FEET IN TRAFFIC AREAS TO BE PROVIDED FOR ALL COLLECTOR LINES 4 INCHES AND LARGER. IF LESS THAN 5 FEET, DUCTILE IRON PIPE SHALL BE REQUIRED.
- MINIMUM SLOPE FOR 4 INCH SANITARY SEWER COLLECTION LINES SHALL BE NO LESS THAN 2.0% WITH CLEANOUTS EVERY 75 LINEAL FEET.
- MINIMUM SLOPE FOR 6 INCH SANITARY SEWER COLLECTION LINES SHALL BE NO LESS THAN 1.0% WITH CLEANOUTS EVERY 75 LINEAL FEET.

WATER:

- WATERLINES WILL BE 3' OFF CURB AND GUTTER UNLESS SHOWN OTHERWISE.
- LAY WATER MAINS AT LEAST 10 FEET LATERALLY FROM EXISTING OR PROPOSED SANITARY SEWERS. IF LOCAL CONDITIONS OR BARRIERS PREVENT A 10 FOOT SEPARATION, LAY THE WATER MAIN WITH AT LEAST 18" VERTICAL SEPARATION ABOVE THE TOP OF THE SANITARY SEWER PIPE EITHER IN A SEPARATE TRENCH OR IN THE SAME TRENCH ON A BENCH OF UNDISTURBED EARTH.
- WHEN A PROPOSED WATER MAIN CROSSES OVER A PROPOSED OR EXISTING SANITARY SEWER, LAY THE WATER MAIN WITH AT LEAST 18" VERTICAL SEPARATION ABOVE THE TOP OF THE SANITARY SEWER. IF LOCAL CONDITIONS PREVENT AN 18" VERTICAL SEPARATION, CONSTRUCT BOTH THE WATER MAIN AND THE SANITARY SEWER FOR A DISTANCE OF 10 FEET ON EACH SIDE TO THE POINT OF CROSSING WITH FERROUS PIPE HAVING WATER MAIN QUALITY JOINTS.
- WHEN A PROPOSED WATER MAIN CROSSES UNDER A PROPOSED OR EXISTING SANITARY SEWER, CONSTRUCT BOTH THE WATER MAIN AND THE SANITARY SEWER OF FERROUS MATERIALS WITH JOINTS THAT ARE EQUIVALENT TO WATER MAIN STANDARDS FOR A DISTANCE OF 10 FEET ON EACH SIDE OF THE POINT OF CROSSING. CENTER THE SECTION OF WATER PIPE AT THE POINT OF CROSSING.
- MAINTAIN A MINIMUM COVER OF 36" AND MAXIMUM COVER OF 42" BELOW FINISHED GRADE OVER ALL PIPES UNLESS OTHERWISE DIRECTED OR SHOWN ON THE PLANS. DUE TO THE HEIGHTS OF VALVES, INCREASE THE COVER DEPTHS ADJACENT TO THE VALVES OR VARIED AT POINTS OF THE-IN TO EXISTING LINES.
- ALL FDC(S) AND HYDRANT(S) SHALL BE SIAMESE CONNECTIONS AND MEET TOWN OF CHAPEL HILL AND OWASA STANDARDS.

electrical

- A SINGLE ELECTRICAL SERVICE SHALL BE PROVIDED TO SERVE THE STRUCTURE WITH THE EXCEPTION OF THE FIRE PUMP. NC ELECTRICAL CODE 230.2(A)2014

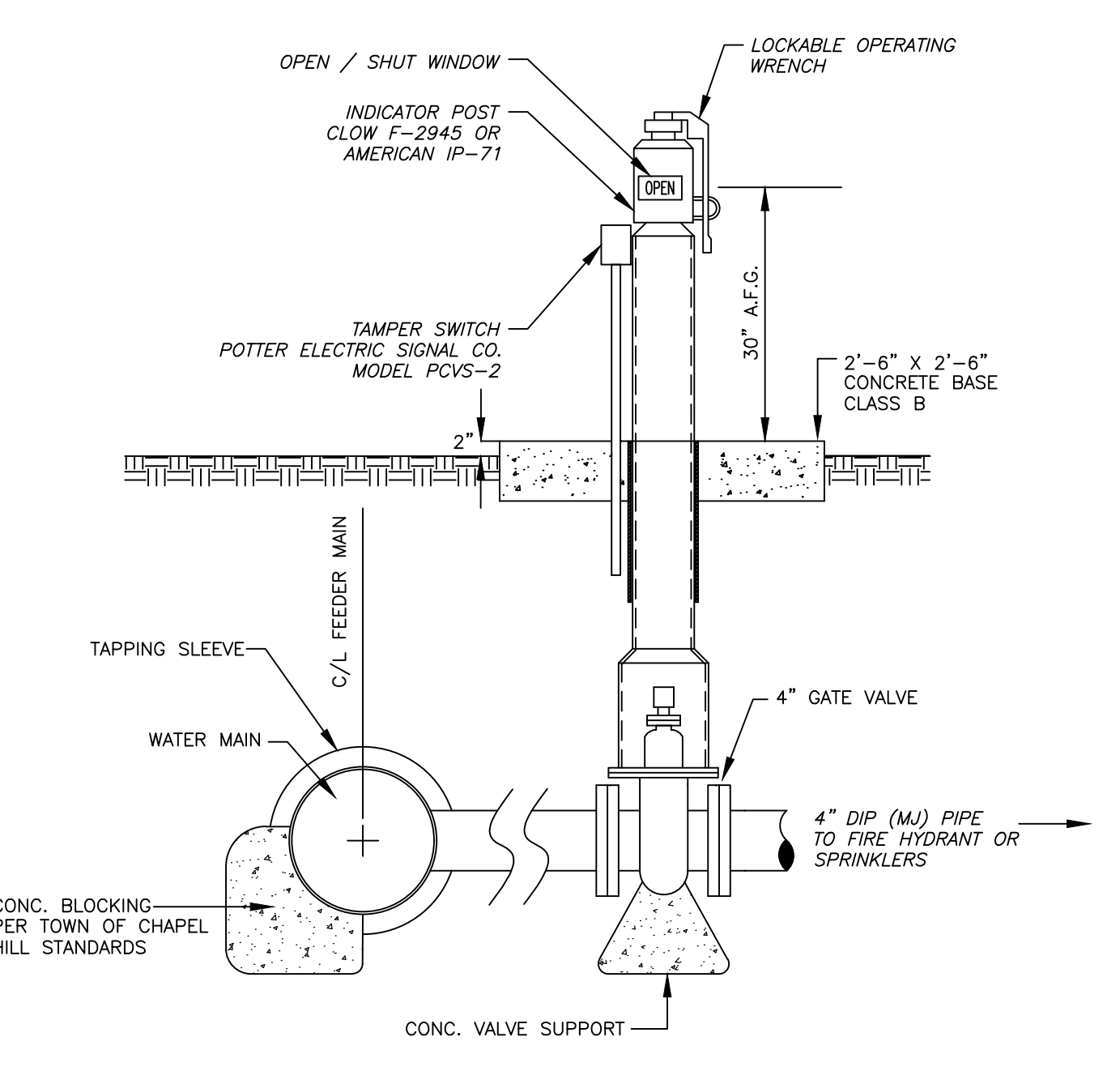

NOTES:
1. COMPLY WITH NFPA 13 AND NFPA 24 FOR INSTALLATION.
2. PROVIDE TAR PAPER BETWEEN HYDRANT AND HYDRANT THRUST BLOCK.
3. ALL THRUST BLOCKS AND SUPPORTING CONCRETE TO BE CLASS B.
4. THE CONTRACTOR IS REQUIRED TO RUN UNDERGROUND CONDUITS TO THE POST INDICATOR VALVE, SO THAT IT CAN BE MONITORED VIA TAMPER SWITCH BY THE FIRE ALARM SYSTEM. PROVIDE (2) 1" CONDUITS FROM SPRINKLER VALVE ROOM TO PIV.

2 POST INDICATOR VALVE (PIV)
C-5.0 N.T.S.

fire protection notes

- PROVIDE EMERGENCY VEHICLE ACCESS TO THE SITE DURING CONSTRUCTION.
- WHEN FENCING IS PROVIDED AROUND PROJECTS DURING CONSTRUCTION, PROVIDE A MINIMUM OF 20' SWING OR SLIDE GATE FOR EMERGENCY VEHICLE ACCESS.
- FIRE APPARATUS ACCESS ROADS SHALL BE ALL WEATHER AND DESIGNED TO CARRY THE IMPOSED LOAD OF FIRE APPARATUS WEIGHING AT LEAST 80,000 LBS.
- FIRE APPARATUS ACCESS ROADS SHALL HAVE A MINIMUM WIDTH OF 20' WITH AN OVERHEAD CLEARANCE OF AT LEAST 13'-6" FOR STRUCTURES NOT EXCEEDING 30' IN HEIGHT AND SHALL PROVIDE ACCESS TO WITHIN 150' OF ALL EXTERIOR PORTIONS OF THE BUILDING.
- FIRE APPARATUS ACCESS ROADS SHALL NOT EXCEED 10% IN GRADE.
- PRIVATE FIRE MAINS SERVING THE SPRINKLER SYSTEM SHALL BE INSTALLED PER NFPA 24. THE FIRE MAIN SHALL BE FLUSHED PER NFPA 24 AND WITNESSED BY A FIRE INSPECTOR FROM CHAPEL HILL FIRE DEPARTMENT PRIOR TO COVERING THE LINE.
- KEY BOX WILL BE REQUIRED FOR THIS PROJECT. PLEASE CONTACT CHRIS KEARNS AT CHFD FOR PROPER ORDER FORM. THE GENERAL CONTRACTOR WILL CONSULT WITH THE CHAPEL HILL FIRE DEPARTMENT DURING CONSTRUCTION TO ENSURE THE BOX IS APPROPRIATELY SIZED AND LOCATED.



Coulter Jewell Thames
RA

111 West Main Street
Durham, N.C. 27701
p 919.682.0368
f 919.688.5646
www.cjtpa.com

NC BOARD OF EXAMINERS FOR ENGINEERS AND SURVEYORS
LIC # C-1208
NC BOARD OF LANDSCAPE ARCHITECTS LIC # C-104

MHAworks
PLANNING ARCHITECTURE INTERIORS
501 WASHINGTON STREET, SUITE G
DURHAM, NORTH CAROLINA 27701
P 919.682.5369
www.mhaworks.com

Project: 11SIXTY5 Weaver Dairy Road

1165 Weaver Dairy Rd.
Chapel Hill, NC 27514

PIN: 9880350595

2-22-18

NOT ISSUED FOR CONSTRUCTION

Job Number: 1529

Drawn	WLR, MTC, VJC
Checked	WLR, VJC
Date	11-30-17
Revisions	TIT COMMENT REVISIONS
	2-22-18
	TOWN COMMENT REVISIONS

SPECIAL USE PERMIT

Sheet Title: UTILITY PLAN

Sheet Number: C-5.0

-CONTRACTION JOINTS SHALL BE SPACED AT 10 FOOT INTERVALS, EXCEPT THAT A 15 FOOT SPACING MAY BE USED WHEN A MACHINE IS USED OR WHEN SATISFACTORY SUPPORT FOR THE FACE FORM CAN BE OBTAINED WITHOUT THE USE OF TEMPLATES AT 10 FOOT INTERVALS. JOINT SPACING MAY BE ALTERED BY THE ENGINEER TO PREVENT UNCONTROLLED CRACKING.
 -CONTRACTION JOINTS MAY BE INSTALLED BY THE USE OF TEMPLATES OR FORMED BY OTHER APPROVED METHODS. WHERE SUCH JOINTS ARE NOT FORMED BY TEMPLATES, A MINIMUM DEPTH OF 1 1/2" SHALL BE MAINTAINED.
 -ALL CONTRACTION JOINTS SHALL BE FILLED WITH JOINT FILLER.
 -JOINTS SHALL MATCH LOCATIONS WITH JOINT IN ADJUTING SIDEWALK.
 -EXPANSION JOINTS SHALL BE SPACED AT 90 FOOT INTERVALS AND ADJACENT TO ALL RIGID OBJECTS.

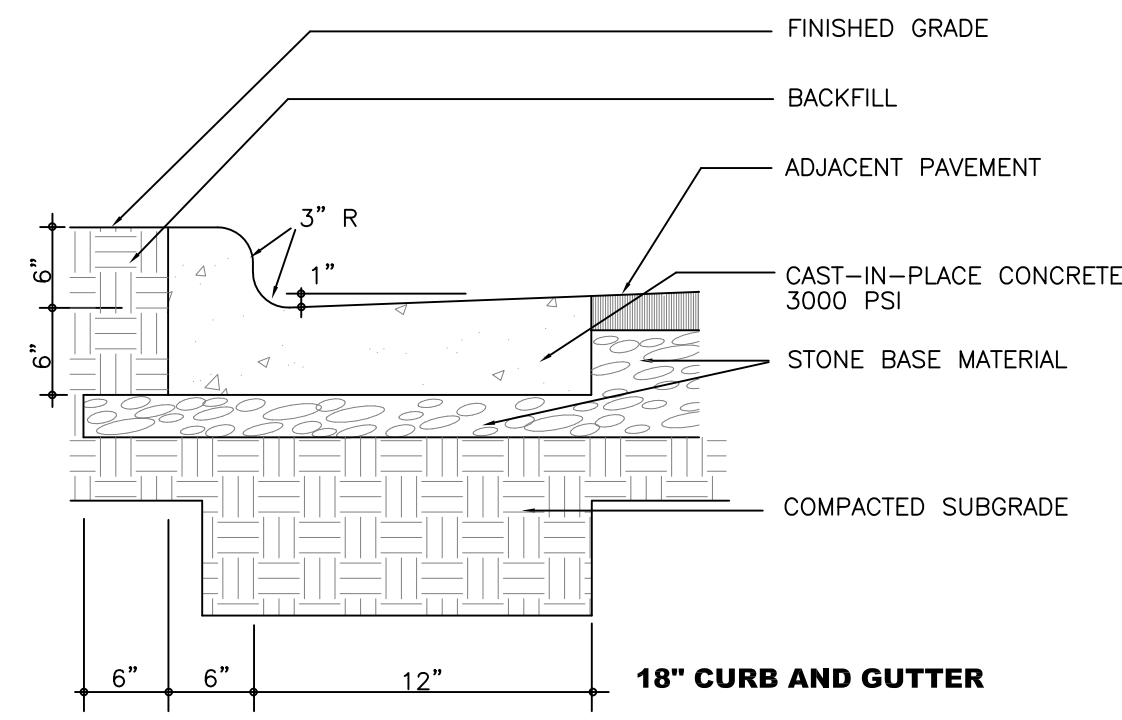

NOTE THAT THIS DETAIL DOES NOT MEET NC DOT REQUIREMENTS. ANY CURB AND GUTTER TO BE CONSTRUCTED IN THE OLD MASON FARM ROAD RIGHT OF WAY IS TO FOLLOW NC DOT STANDARDS RE: 2/C700

1 ON SITE CURB AND GUTTER
C-7.0 NTS

-CONTRACTION JOINTS SHALL BE SPACED AT 10 FOOT INTERVALS, EXCEPT THAT A 15 FOOT SPACING MAY BE USED WHEN A MACHINE IS USED OR WHEN SATISFACTORY SUPPORT FOR THE FACE FORM CAN BE OBTAINED WITHOUT THE USE OF TEMPLATES AT 10 FOOT INTERVALS. JOINT SPACING MAY BE ALTERED BY THE ENGINEER TO PREVENT UNCONTROLLED CRACKING.
 -CONTRACTION JOINTS MAY BE INSTALLED BY THE USE OF TEMPLATES OR FORMED BY OTHER APPROVED METHODS. WHERE SUCH JOINTS ARE NOT FORMED BY TEMPLATES, A MINIMUM DEPTH OF 1 1/2" SHALL BE MAINTAINED.
 -ALL CONTRACTION JOINTS SHALL BE FILLED WITH JOINT FILLER.
 -JOINTS SHALL MATCH LOCATIONS WITH JOINT IN ADJUTING SIDEWALK.
 -EXPANSION JOINTS SHALL BE SPACED AT 90 FOOT INTERVALS AND ADJACENT TO ALL RIGID OBJECTS.

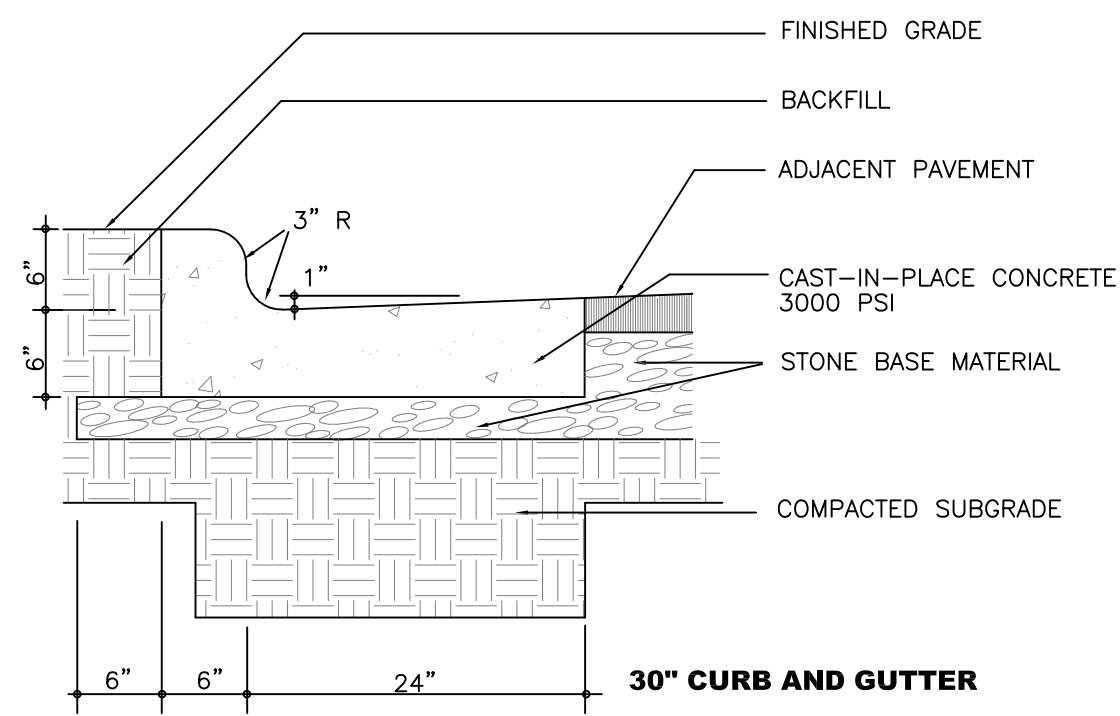

2 NCDOT CURB AND GUTTER
C-7.0 NTS

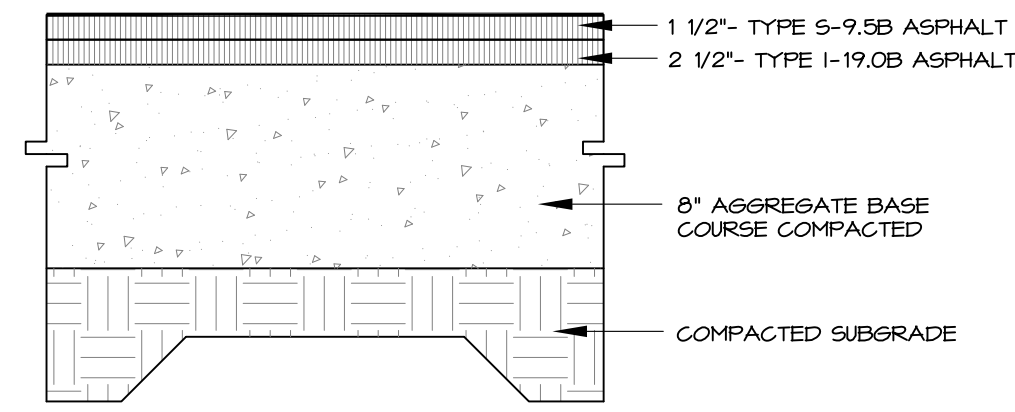

FINAL PAVEMENT SECTION IS PROVIDED BY GEO-TECHNICAL ENGINEER BASED SITE SPECIFIC GEO-TECHNICAL REPORT

3 ASPHALT PAVING
C-7.0 NTS

NOTES:

- ALL CONCRETE TO 4000 PSI, PROPERLY AIR ENTRAINED FOR EXTERIOR GRADE CONCRETE MIXES.
- CABC BASE AND SOIL SUBGRADE TO BE COMPACTED TO 98% OF THE ASTM D-698 STD. PROCTOR MDD AND PROOFROLLED AND APPROVED BY GEOTECHNICAL PERSONNEL.

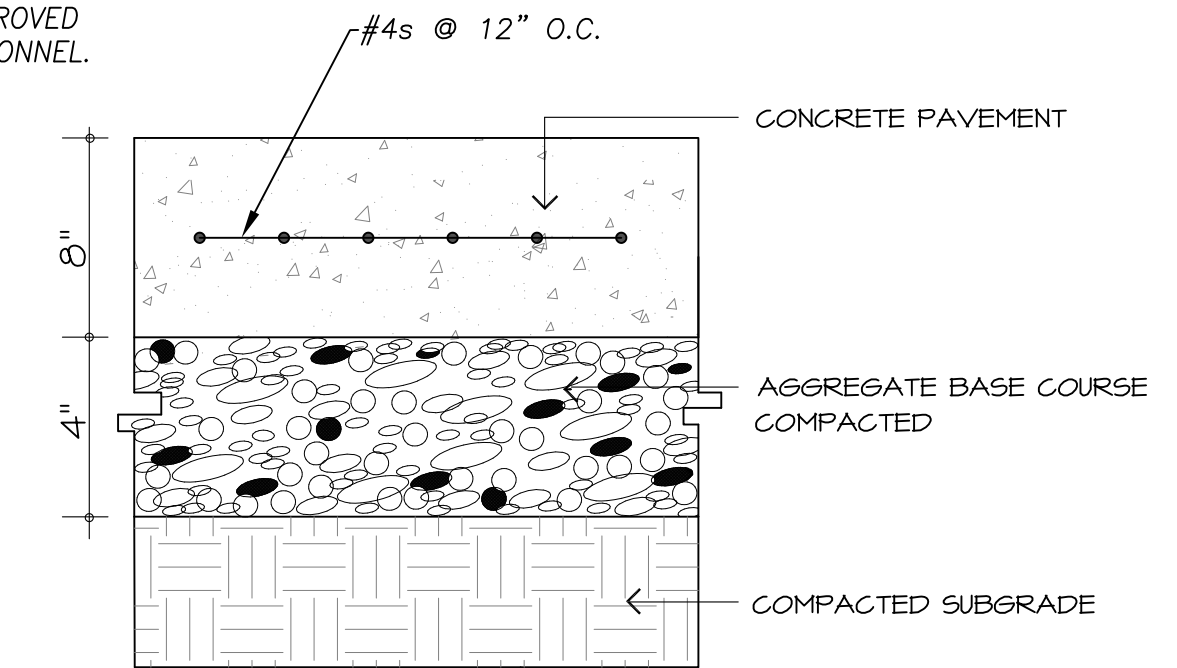

4 HEAVY DUTY CONCRETE PAVING
C-7.0 NTS

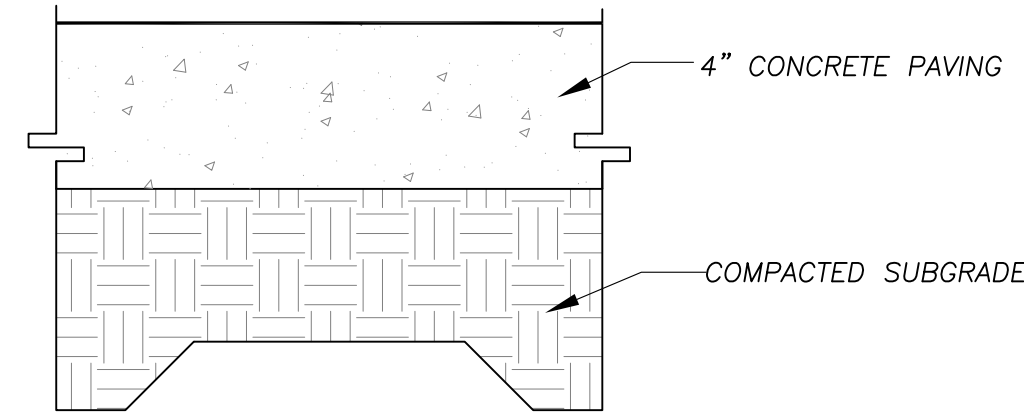

- NOTES:
- ALL CONCRETE 3000 PSI.
 - ALL SIDEWALKS SHALL BE CONSTRUCTED WITH TOOLED 1/4" EDGE RADIUS.
 - BROOM FINISH
 - SIDEWALKS ARE TO HAVE A MAXIMUM CROSS SLOPE OF 2.0%.

5 SIDEWALK
C-7.0 NTS

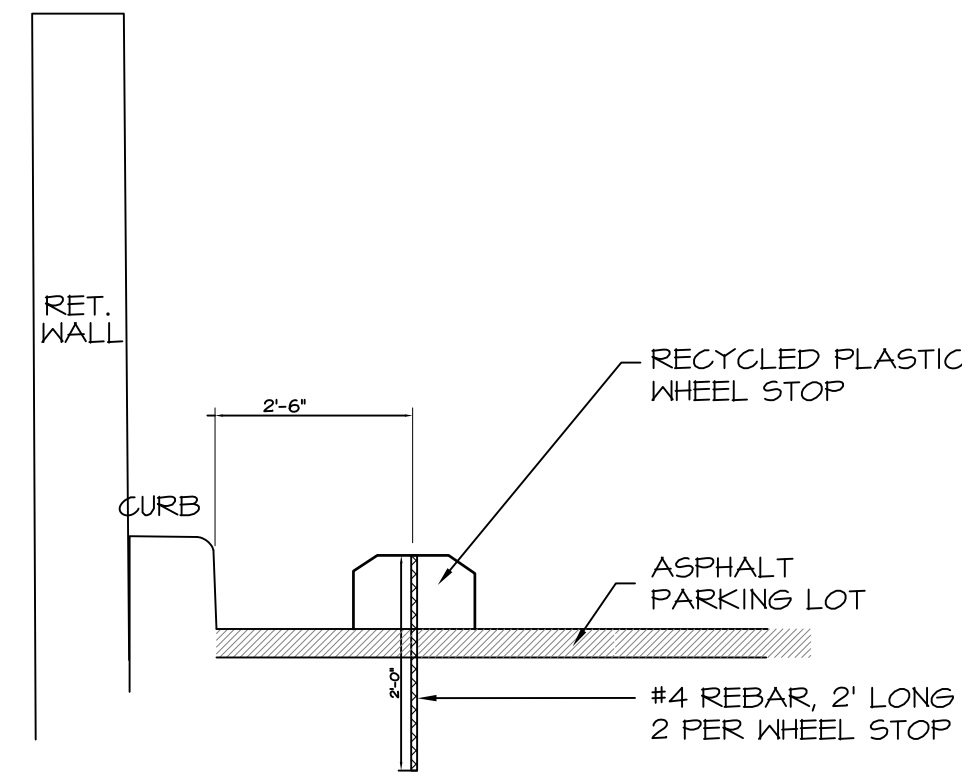

6 WHEEL STOP
C-7.0 NTS

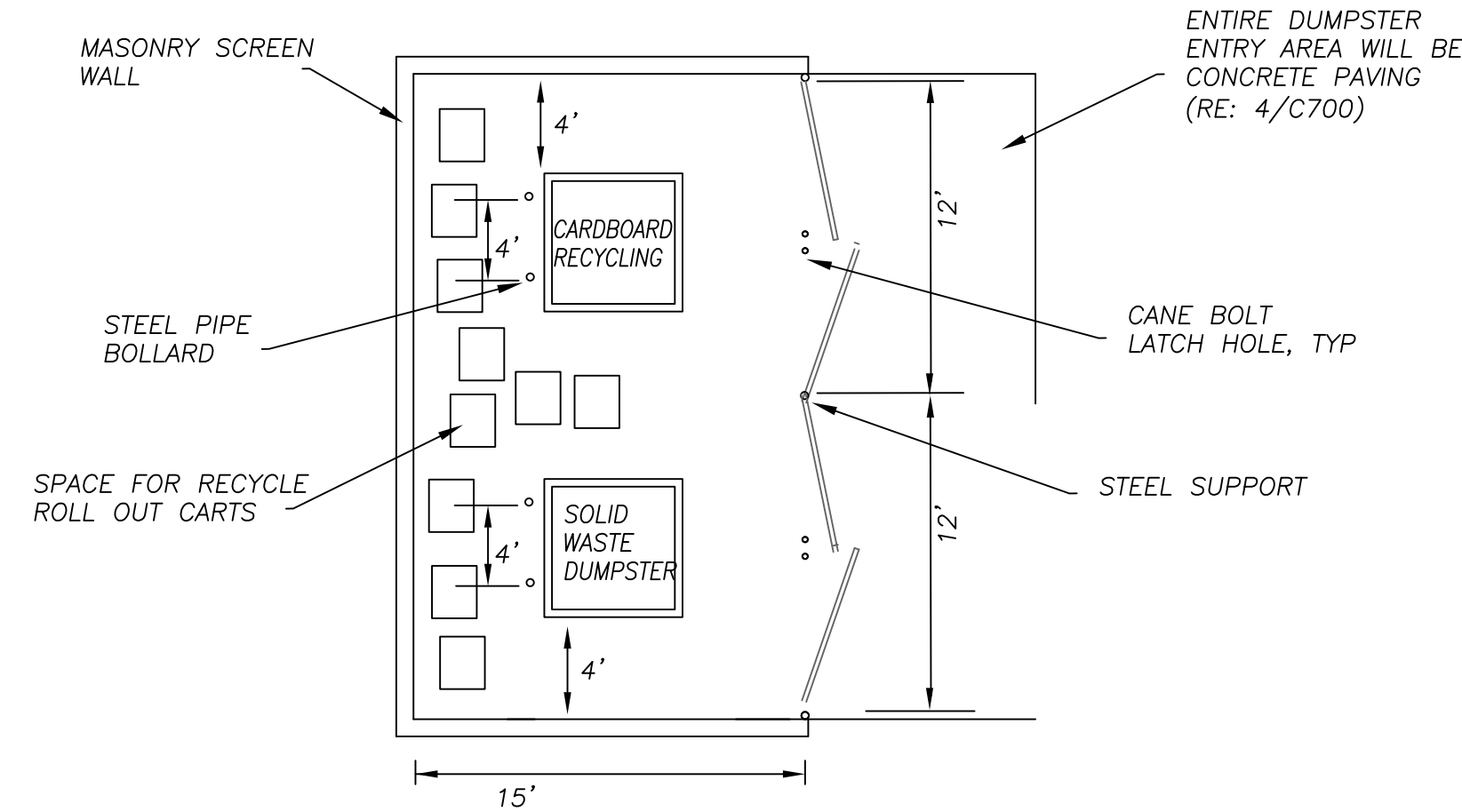

7 DUMPSTER ENCLOSURE
C-7.0 NTS

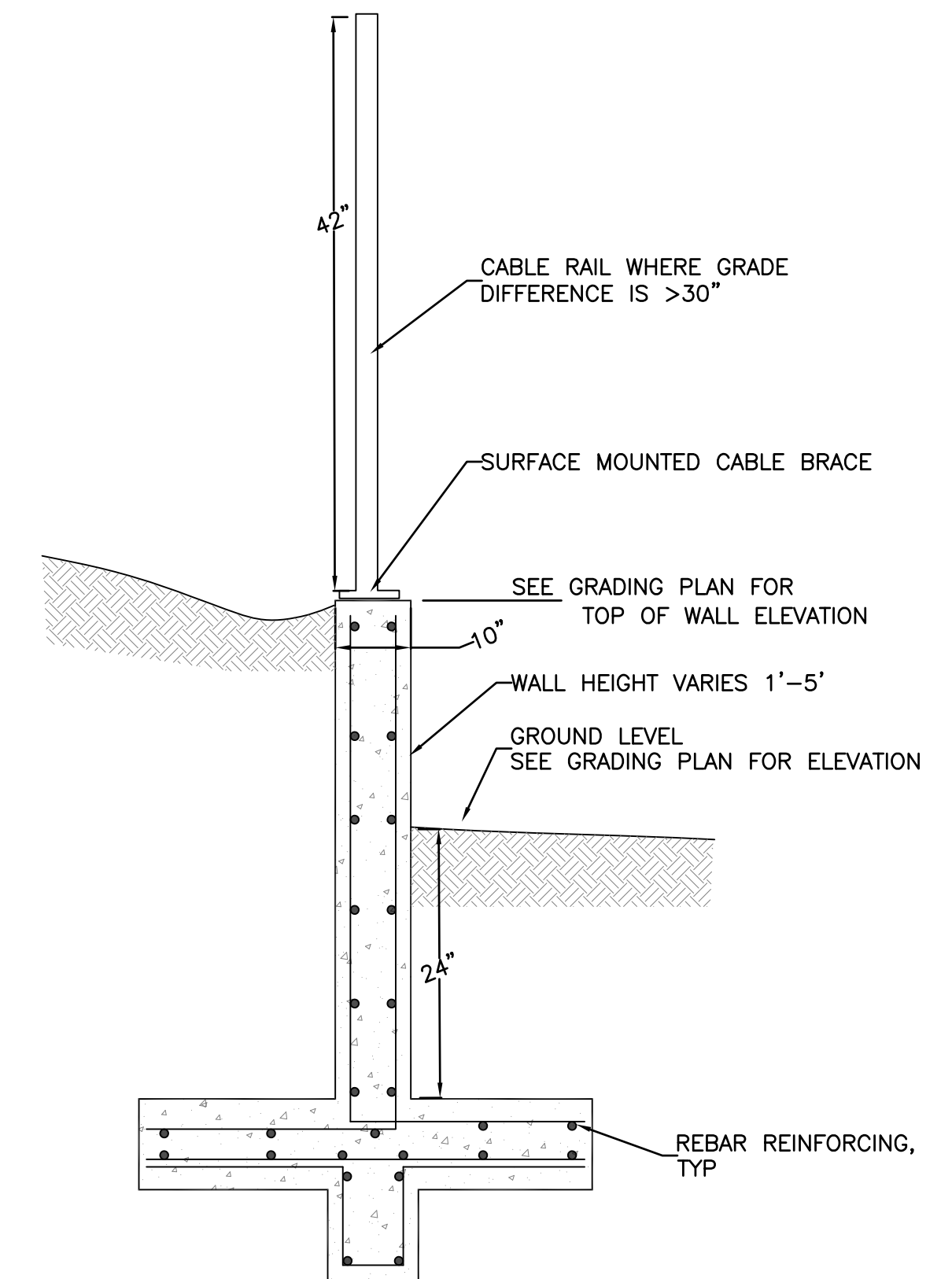

10 RETAINING WALL WITH RAILING
C-7.0 NTS

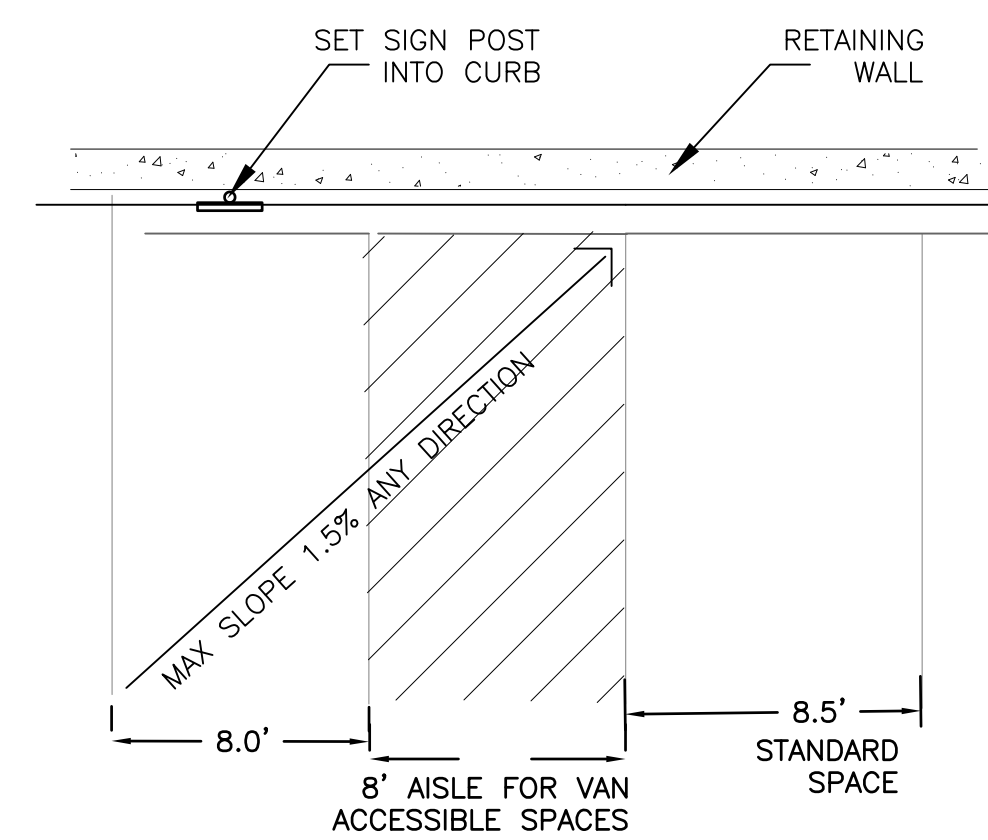

PLAN VIEW

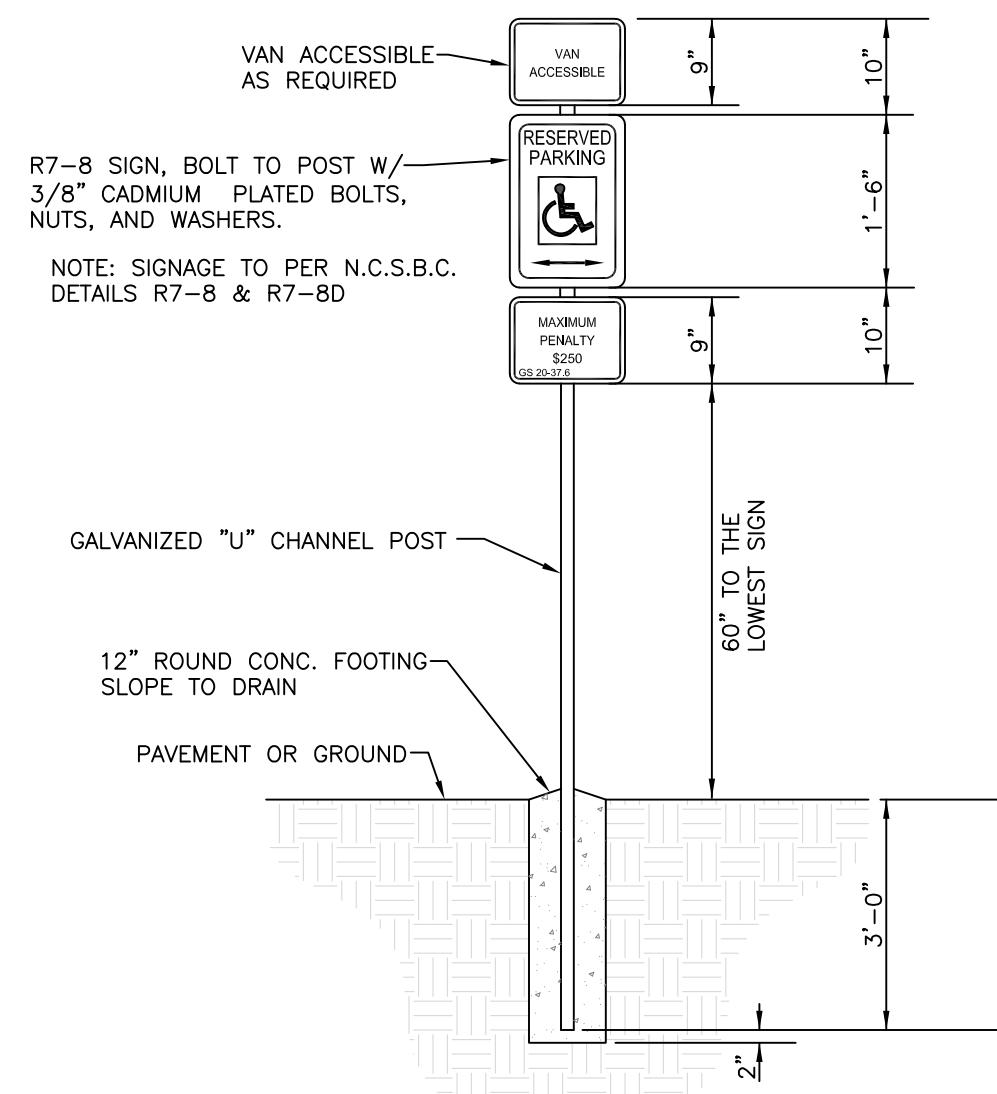

- GENERAL NOTES:
- REGARDLESS OF AGE, ALL ACCESSIBLE SPACES SHALL BE IDENTIFIED BY ABOVE-GROUND SIGNS ONLY.
 - NEW SPACES SHALL NOT USE GROUND-PAINTED SYMBOLS.
 - ACCESSIBLE SPACES ARE REQUIRED TO BE STRIPED OFF ONLY; BLUE COLORING IS NOT NECESSARY NOR REQUIRED.
 - STRIPING IS WHITE ON DARK PAVEMENT; BLACK ON LIGHT PAVEMENT. (N.C.D.O.T.)

8 SURFACE HANDICAP PARKING
C-7.0 NTS

9 NOT USED
C-7.0



Coulter Jewell Thames P.A.

111 West Main Street
Durham, N.C. 27701
p 919.682.0368
f 919.688.5646
www.cjtpa.com

NC BOARD OF EXAMINERS FOR ENGINEERS AND SURVEYORS
LIC # C-1209
NC BOARD OF LANDSCAPE ARCHITECTS LIC # C-104

MHAworks ARCHITECTURE INTERIORS PLANNING ARCHITECTURE SUSTAINABILITY

101 WASHINGTON STREET, SUITE G
DURHAM, NORTH CAROLINA 27601
p 919.682.2870
f 919.682.5369
www.mhaworks.com

2030 Commitment

Project:
11SIXTY5
Weaver Dairy Road

1165 Weaver Dairy Rd.
Chapel Hill, NC 27514

PIN:
9880350595

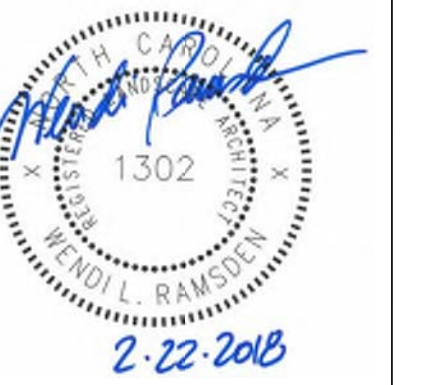

NOT ISSUED FOR CONSTRUCTION

Job Number: 1529

Drawn	WLR, MTC, VJC
Checked	WLR, VJC
Date	11-30-17
Revisions	1-25-18 TRT COMMENT REVISIONS
	2-22-18 TOWN COMMENT REVISIONS

SPECIAL USE PERMIT

Sheet Title:

SITE DETAILS

Sheet Number
C-7.0

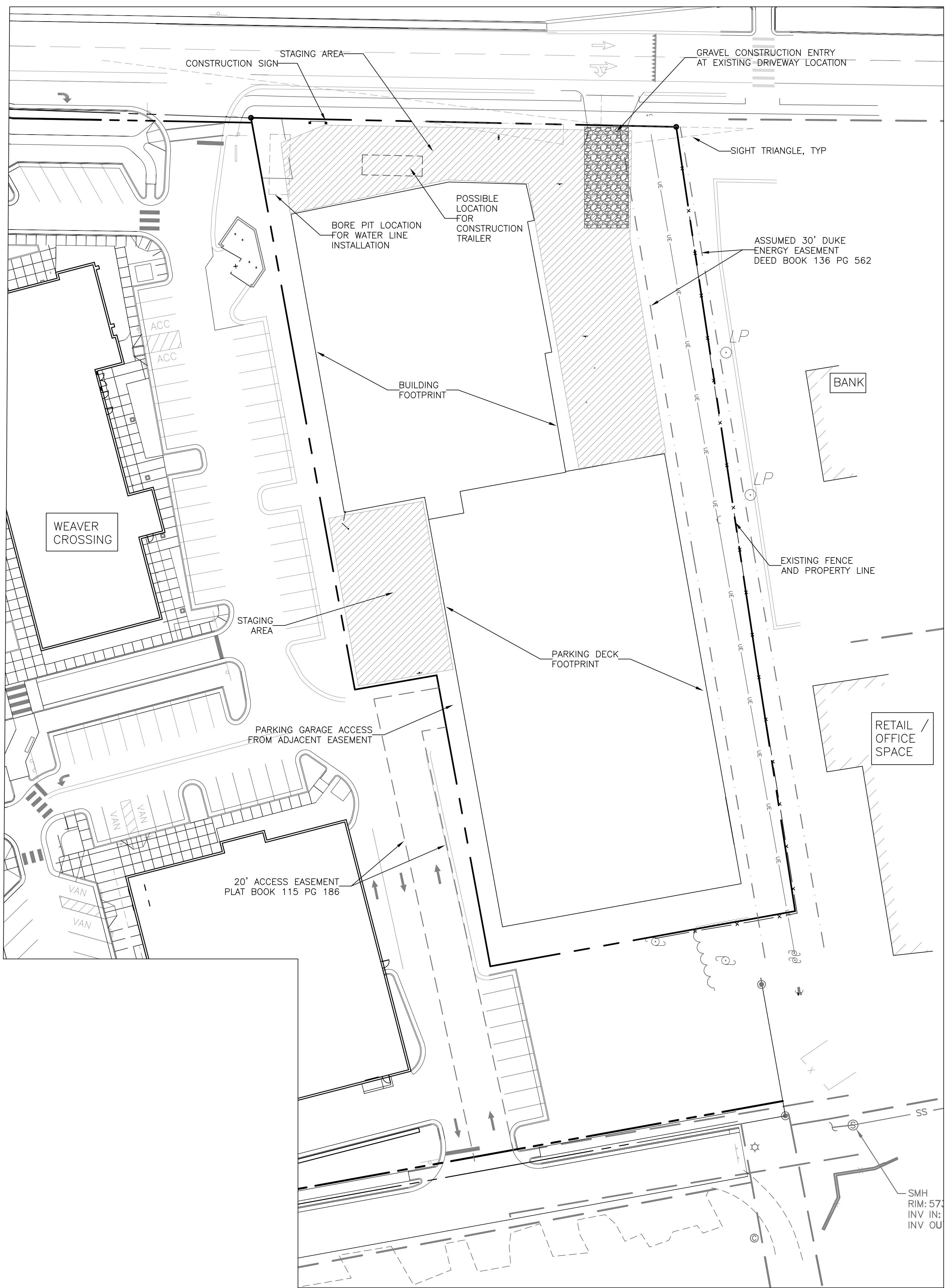

TOWN NOISE ORDINANCE:
 -COMPLIANCE WITH THE TOWN NOISE ORDINANCE IS REQUIRED DURING THE CONSTRUCTION OF THIS PROJECT.

GENERAL CONSTRUCTION NOTES:
 -A NCDOT ENCROACHMENT AGREEMENT IS REQUIRED PRIOR TO THE START OF ANY WORK IN THE PUBLIC RIGHT-OF-WAY.
 -ALL PUBLIC SITE ELEMENTS MUST COMPLY WITH NCBC 2012 CH 11 AND ICC A 117.1. CONTACT TOWN FOR INSPECTION OF FORMS PRIOR TO PLACING CONCRETE FOR CURB CUTS AND ACCESSIBLE ROUTES. IN ACCORDANCE WITH THESE REGULATIONS, ANY SIDEWALK EXCEEDING 5% SLOPE WILL BE CONSIDERED A RAMP.

ON SITE CONSTRUCTION NOTE:
 -CURB CUTS AND ACCESSIBLE ROUTES PER ICC A117.1 2009 ED. CROSS SLOPE IS LIMITED TO 1.8%.

CONSTRUCTION PARKING NOTE:
 -CONSTRUCTION PARKING IS ALLOWED IN CONSTRUCTION STAGING AREAS AND IN THE CONSTRUCTION AREAS ON THE PROJECT SITE DURING THE PROJECT. CONSTRUCTION PARKING WILL NOT BE ALLOWED ON ADJACENT RESIDENTIAL STREETS.

CONSTRUCTION STAGING NOTES

1. CONTRACTOR IS TO ARRANGE FOR CONSTRUCTION PARKING WITHIN THE STAGING AREA OR OFF SITE. NO CONSTRUCTION PARKING WILL BE ALLOWED ON ADJACENT RESIDENTIAL STREETS.
2. FIRE HYDRANTS MUST BE FULLY OPERATIONAL AND PHYSICALLY APPROVED BY OWASA BEFORE COMBUSTIBLE MATERIALS CAN BE BROUGHT INTO THE SITE.

2 CONSTRUCTION NOTES

C-1.1 NTS

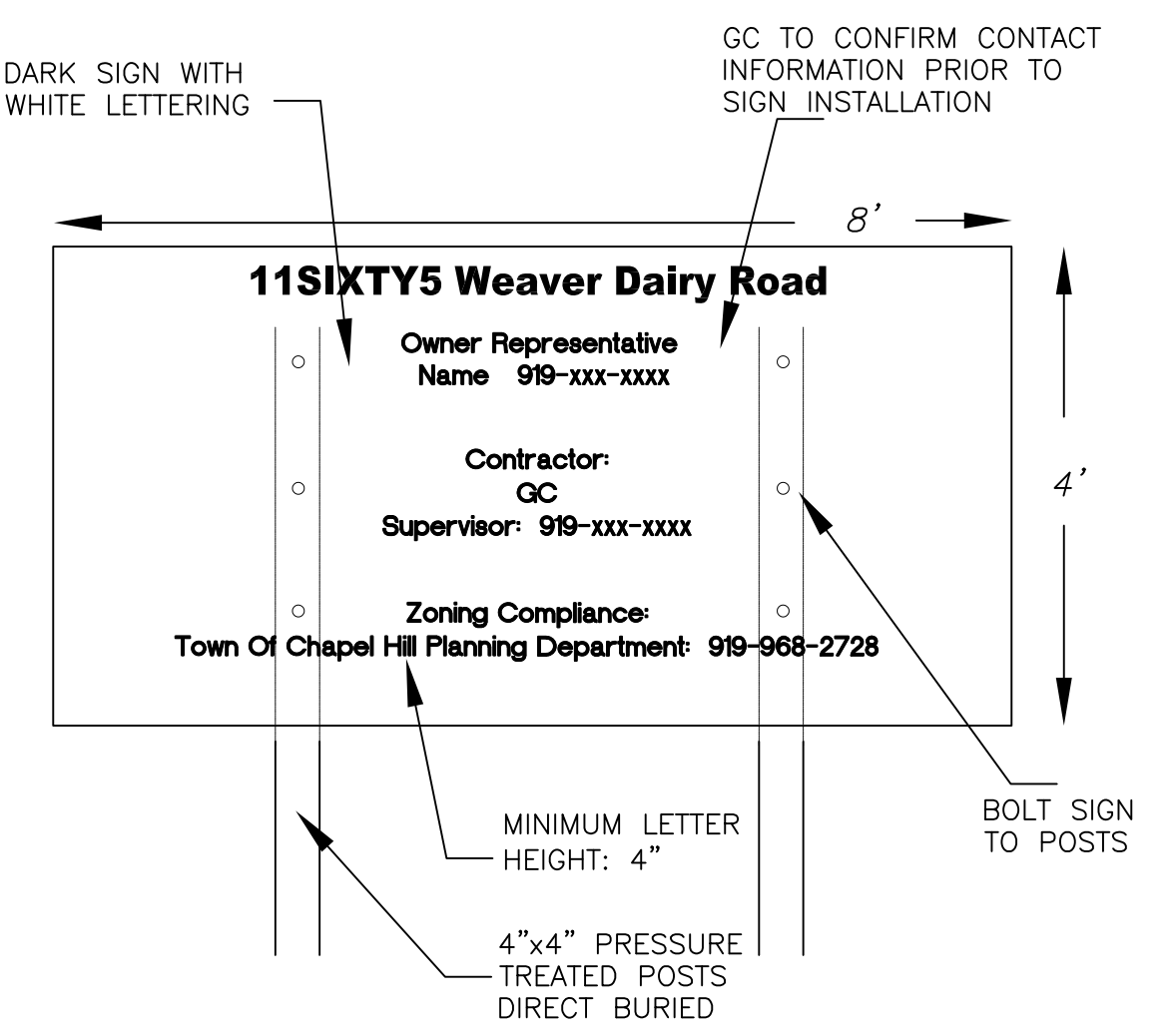

- NOTES:**
1. SIGN IS TO INCLUDE THE FOLLOWING INFORMATION: PROJECT NAME, OWNER CONTACT, CONTRACTOR CONTACT, ZONING COMPLIANCE CONTACT.
 2. SIGN IS TO BE A MAXIMUM OF 4' X 8'
 3. SIGN IS TO BE REMOVED AT PROJECT COMPLETION

3 CONSTRUCTION SIGN

C-1.1 NTS

FIRE PROTECTION NOTES

1. EMERGENCY ACCESS FOR APPARATUS SHALL BE PROVIDED BY THE CONTRACTOR AT ALL TIMES.
2. DURING CONSTRUCTION AND DEMOLITION WHERE HOT WORK, MATERIALS SUBJECT TO SPONTANEOUS COMBUSTION, OR OTHER HAZARDOUS CONSTRUCTION OR DEMOLITION IS OCCURRING, THE OWNER OR THEIR DESIGNEE SHALL BE RESPONSIBLE FOR MAINTAINING A FIRE WATCH. THE FIRE WATCH SHALL CONSIST OF AT LEAST ONE PERSON WITH A MEANS OF COMMUNICATING AN ALARM TO 911, A WRITTEN ADDRESS SHALL BE POSTED IN A CONSPICUOUS LOCATION AND SHALL MAINTAIN CONSTANT PATROLS. NC FPC 2012 SECTION 1404
3. ALL CONSTRUCTION AND DEMOLITION SHALL COMPLY WITH THE CURRENT EDITION OF CHAPTER 14 OF THE NC FPC (FIRE CODE).
4. ANY PERMANENT OR TEMPORARY GATES ACROSS FIRE ACCESS DRIVES SHALL BE A MINIMUM WIDTH OF 20', EITHER SWINGING OR SLIDING TYPE, HAVE AN EMERGENCY MEANS OF OPERATION, AND SHALL BE OPERABLE BY EITHER FORCIBLE ENTRY OR KEYS, CAPABLE OF BEING OPERATED BY ONE PERSON, AND SHALL BE INSTALLED AND MAINTAINED ACCORDING TO UL 325 AND ASTM F 2200 NC FPC 2012.
5. WHEN THE BUILDING BEING CONSTRUCTED REQUIRES STANDPIPES, A TEMPORARY STANDPIPE CONNECTION WILL BE CONSTRUCTED WITH READY FIRE DEPARTMENT ACCESS WHEN THE BUILDING IS NOT MORE THAN 40' IN HEIGHT. SUCH STANDPIPES SHALL PROVIDE USABLE CONNECTIONS ADJACENT TO THE STAIRS AND SHALL CONTINUE WITH BUILDING PROGRESSION ALWAYS BEING NOT MORE THAN ONE FLOOR BELOW THE HIGHEST FLOOR OF THE BUILDING. NC FPC 2012 SECTION 1413.

TRAFFIC/PEDESTRIAN CONTROL NOTES

1. SIGNS SHOWN ON THIS PLAN ARE REQUIRED DURING THE CONSTRUCTION OF THIS PROJECT.
2. CONSTRUCTION WILL REQUIRE TEMPORARY SIDEWALK AND LANE CLOSURES ON WEAVER DAIRY ROAD.
3. NOTIFY TOWN OF CHAPEL HILL ENGINEERING DEPARTMENT AT 919-968-2833, MINIMUM 72 HOUR NOTICE IS REQUIRED.
4. ALL WORK ZONE SIGNAGE SHALL COMPLY WITH APPLICABLE M.U.T.C.D. STANDARDS AND DETAILS.
5. TEMPORARY LANE CLOSURES ARE ONLY ALLOWED DURING DAYLIGHT HOURS AND A FLAGMAN MUST BE PRESENT AT ALL TIMES WHEN WORK IS OCCURRING IN THE TRAFFIC LANES.
6. PRIOR TO ANY TRAFFIC LANE CLOSURES, IT WILL BE NECESSARY TO CONTACT ERNIE ROGERS AT 919-968-2833, OF THE CHAPEL HILL ENGINEERING DIVISION, AT LEAST 5 WORKING DAYS BEFORE THE PROPOSED WORK TO APPLY FOR A LANE CLOSURE PERMIT.
7. SIGNS AND TEMPORARY BARRICADES AS SHOWN BELOW WILL BE PLACED TO DIRECT PEDESTRIANS WHEN SIDEWALKS ARE IN THE CONSTRUCTION AREAS.

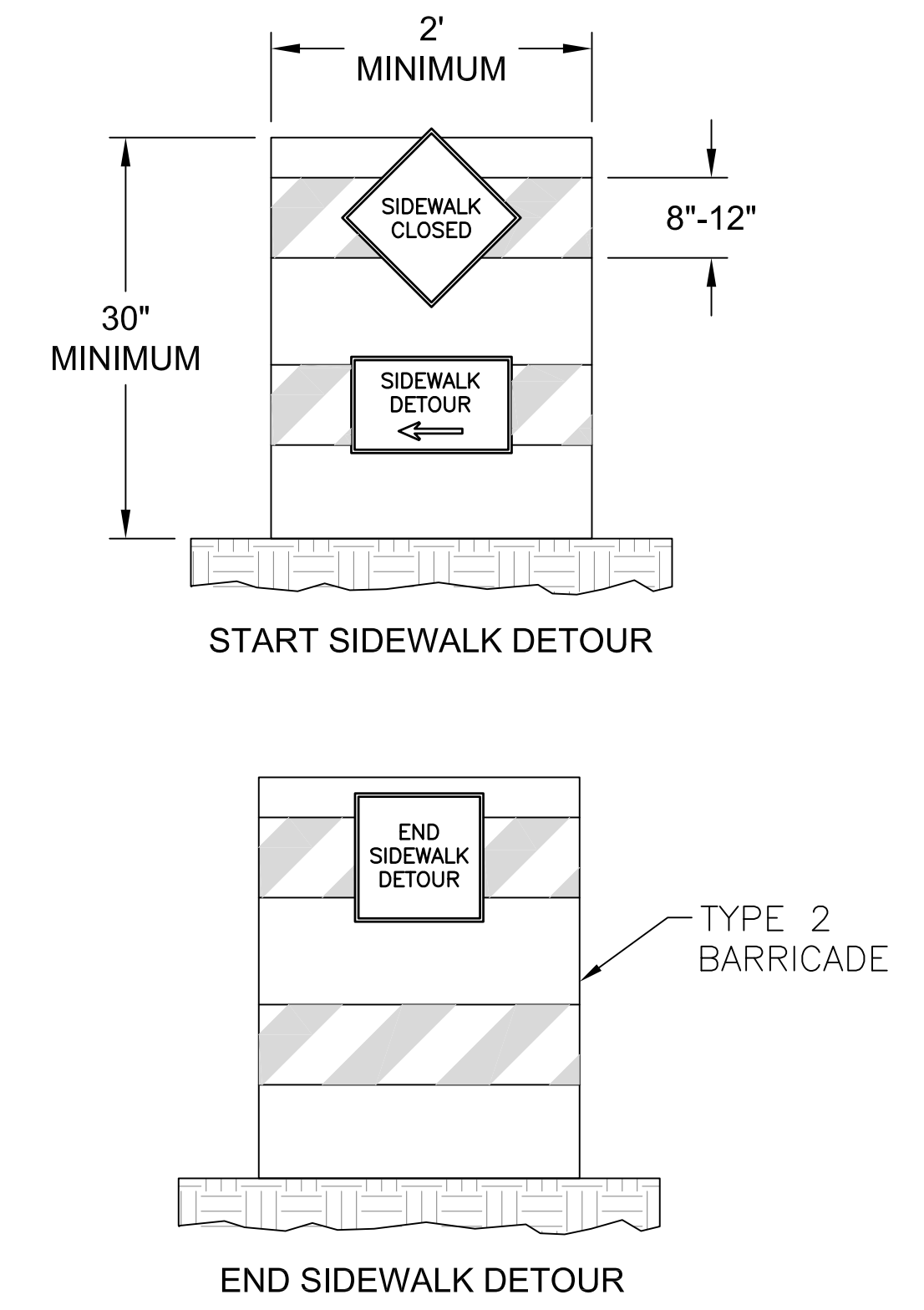

3 TEMPORARY SIDEWALK CLOSURE SIGN

C-1.1 NTS

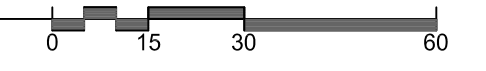

Coulter Jewell Thames, PA.
 ENGINEERING, PLANNING, LANDSCAPE ARCHITECTURE

111 West Main Street
 Durham, N.C. 27701
 p 919.682.0368
 f 919.688.5646
 www.cjtpa.com

NC BOARD OF EXAMINERS FOR ENGINEERS AND SURVEYORS LIC # C-1209
 NC BOARD OF LANDSCAPE ARCHITECTS LIC # C-104

MHAworks
 INTERIORS ARCHITECTURE PLANNING
 501 WASHINGTON STREET SUITE G DURHAM NORTH CAROLINA 27701
 P 919.682.8770 F 919.682.5569 www.mhaworks.com

AIA 2030 Commitment SUSTAINABILITY

Project:

11SIXTY5 Weaver Dairy Road

1165 Weaver Dairy Rd. Chapel Hill, NC 27514

PIN: 9880350595



NOT ISSUED FOR CONSTRUCTION

Job Number: 1529

Drawn	WLR, MTC, VJC
Checked	WLR, VJC
Date	11-30-17
Revisions	1-25-18
	TRT COMMENT REVISIONS
	2-22-18
	TOWN COMMENT REVISIONS

SPECIAL USE PERMIT

Sheet Title:

CONSTRUCTION MANAGEMENT PLAN

Sheet Number

C-1.1

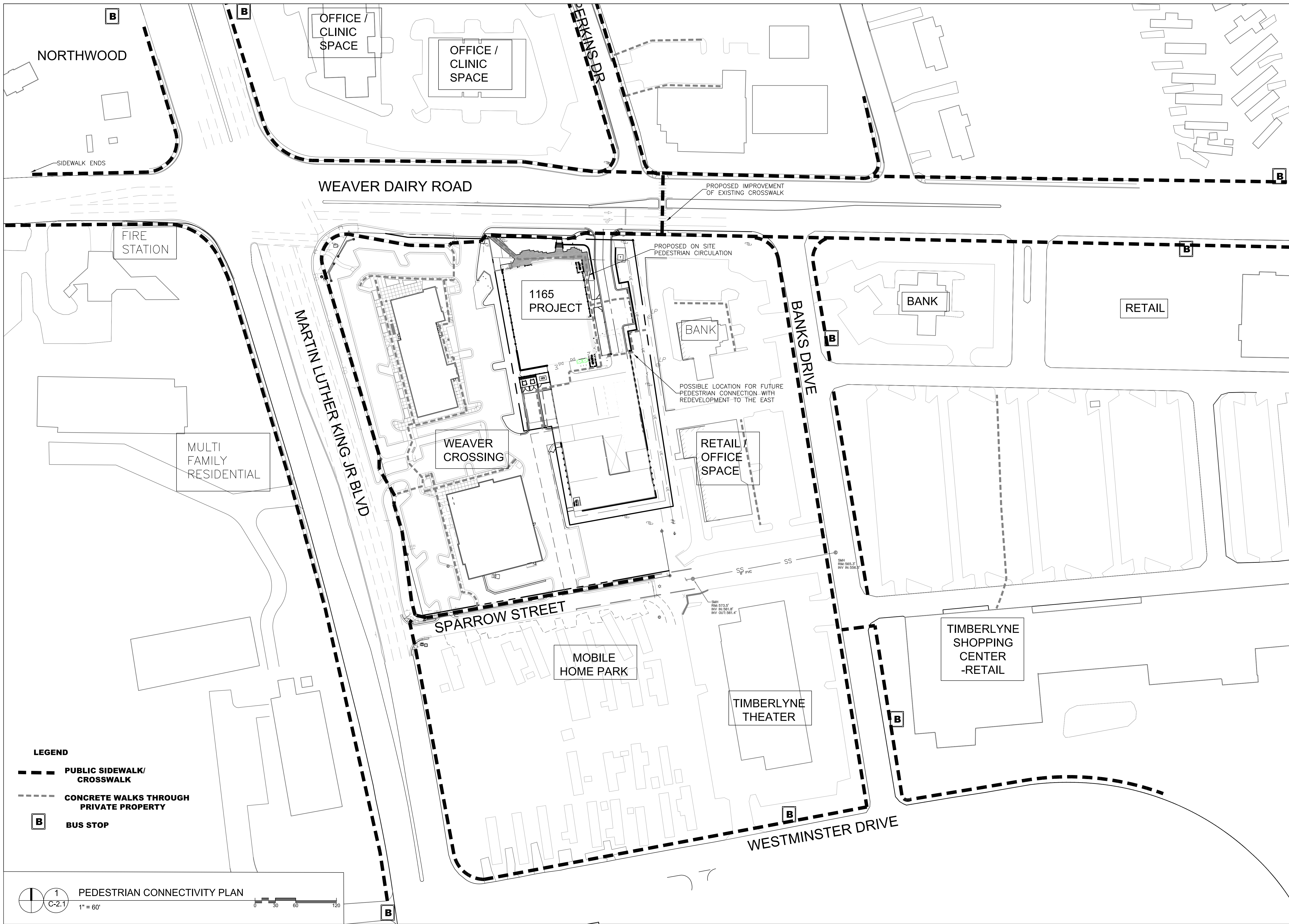

- LEGEND**
- PUBLIC SIDEWALK/ CROSSWALK
 - CONCRETE WALKS THROUGH PRIVATE PROPERTY
 - BUS STOP

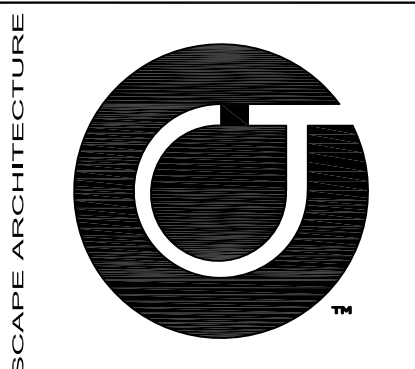

Coulter Jewell Thames
 ENGINEERING, PLANNING, LANDSCAPE ARCHITECTURE

111 West Main Street
 Durham, N.C. 27701
 p 919.682.0368
 f 919.688.5646
 www.cjtpa.com

NC BOARD OF EXAMINERS FOR ENGINEERS AND SURVEYORS
 LIC # C-1209
 NC BOARD OF LANDSCAPE ARCHITECTS LIC # C-104

MHAworks
 INTERIORS
 ARCHITECTURE
 PLANNING

501 WASHINGTON STREET, SUITE G
 DURHAM, NORTH CAROLINA, 27701
 p 919.682.2870
 f 919.682.2569
 www.mhaworks.com

AIA 2030 Commitment | SUSTAINABILITY

Project:
**11SIXTY5
 Weaver Dairy Road**
 1165 Weaver Dairy Rd.
 Chapel Hill, NC 27514

PIN:
 9880350595



NOT ISSUED FOR CONSTRUCTION

Job Number: 1529

Drawn	WLR, MTC, VJC
Checked	WLR, VJC
Date	11-30-17
Revisions	1-25-18
	TRT COMMENT REVISIONS
	2-22-18
	TOWN COMMENT REVISIONS

SPECIAL USE PERMIT

Sheet Title:

PEDESTRIAN CONNECTIVITY PLAN

Sheet Number
C-2.1

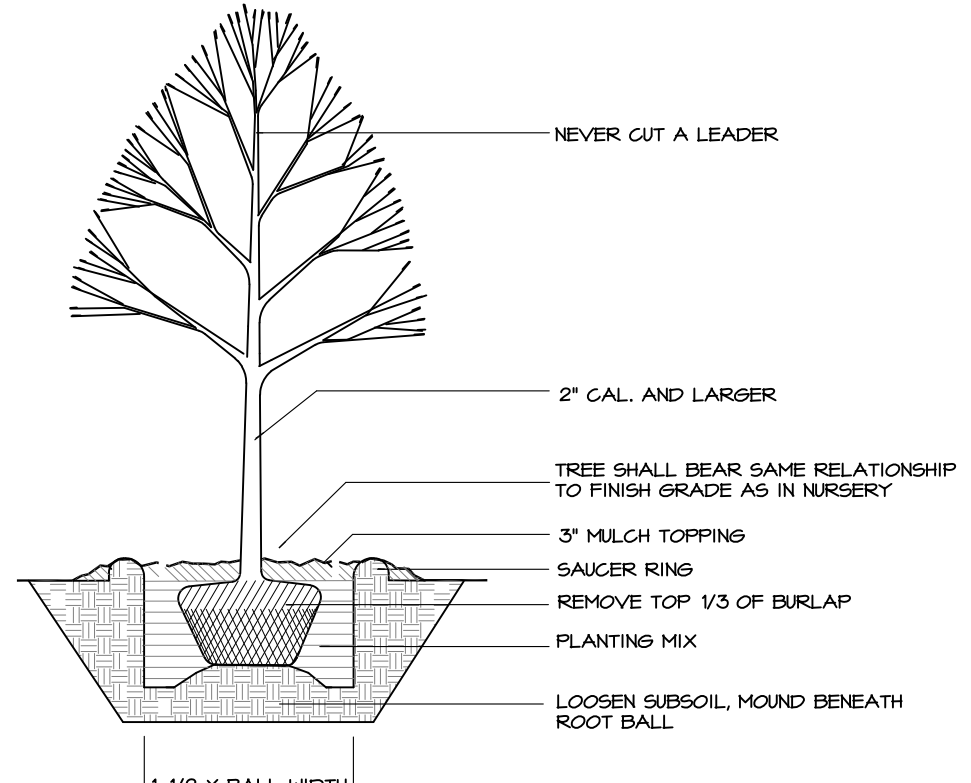
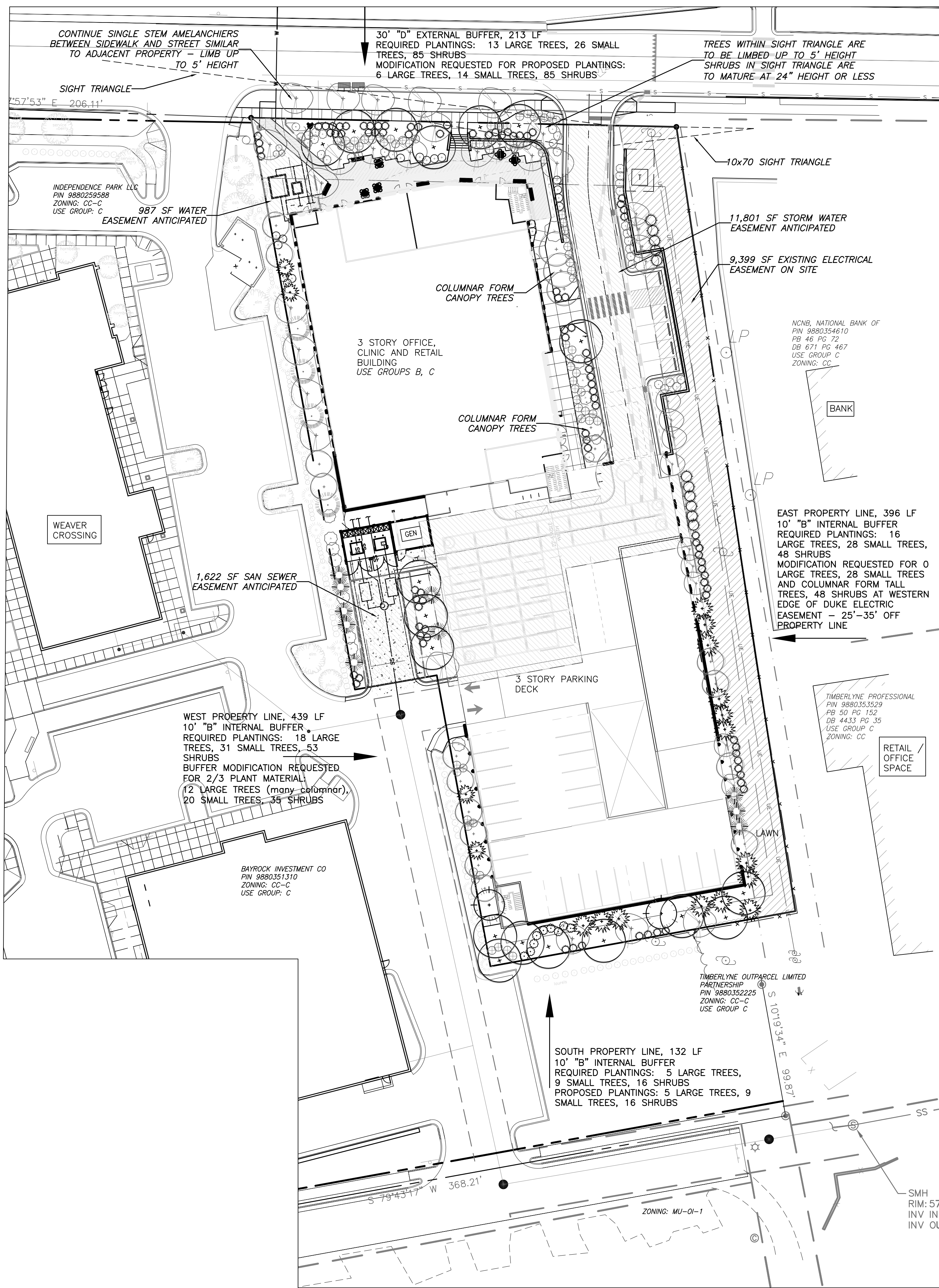

2 TREE PLANTING DETAIL
L-1.0 NTS

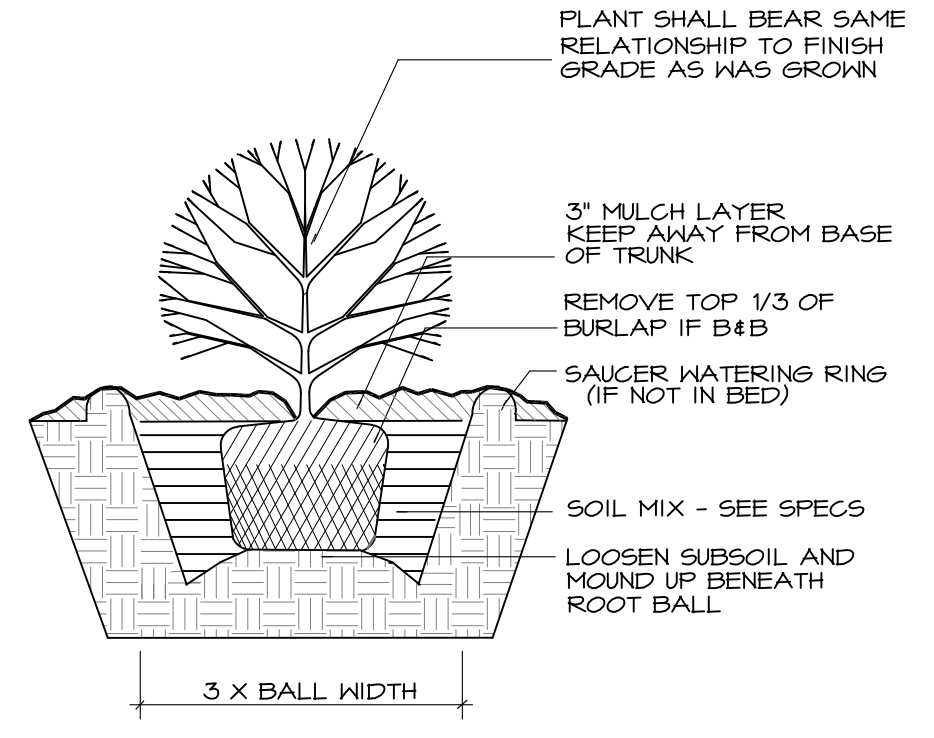

3 SHRUB PLANTING DETAIL
L-1.0 NTS

- LANDSCAPE BUFFER PLAZA / PLANTINGS WILL INCLUDE A SELECTION FROM:
- CANOPY TREES:**
 ACER RUBRUM 'AUTUMN BLAZE' - Autumn Blaze Red Maple
 ACER SACCHARUM 'Legacy' - Legacy Sugar Maple
 CARPINUS BETULUS 'Fastigata' - Upright Hornbeam
 LIQUIDAMBER STYRACIFLUA 'Rotundiloba' - Fruitless Sweet Gum
 QUERCUS NUTALLII - Nuttall Oak
 ULMUS AMERICANA 'Princeton' - Princeton Elm
- INSTALLATION SIZE WILL BE MIN 2 1/2\" CALIBER
- UNDERSTORY TREES:**
 AMELANCHEIR SPP AUTUMN BRILLIANCE - Autumn Brilliance Serviceberry
 CORNUS FLORIDA 'White Cloud' - White Flowering Dogwood
 CORNUS KOUSA - Kousa Dogwood
 ILEX CORNUTA 'Steads' - Steeds Holly
 LAGERSTROEMIA FAUREI - Grape Myrtle
 PRUNUS LAUROCERASUS - Cherry Laurel
 MYRICA CERIFERA - Southern Wax Myrtle
 THUJA STANDISH x PLICATA 'Green Giant' - Green Giant Arborvitae
 VITEX AGNUS-CASTUS - Chaste Tree
- INSTALLATION SIZE WILL BE MIN 6\" HEIGHT
- SHRUBS/GROUNDCOVER:**
 ABELIA X GRANDIFLORA - Glossy Abelia
 BUXUS - Boxwood varieties
 CAMELLIA JAPONICA - Japanese Camellia
 CALLICARPA AMERICANA - American Beautyberry
 CEPHALOTAXUS HARRINGTONIA 'Fastigata' - Upright Plum Yew
 EUKOMYUS JAPONICUS 'Monesse' - Silver Princess Euconymus
 GARDENIA JASMINOIDES - Gardenia varieties
 HELLEBORUS ORIENTALIS - Lenten Rose
 ILEX GLABRA - Inkberry
 ILEX VERTICILLATA - Deciduous Holly
 ILLICIAM PARVIFLORUM - Anise
 LIRIOPE MUSCARI - Liriope
 MUHLENBERGIA CAPILLARIS - Pink Muhly Grass
 MYRICA CERIFERA - Southern Waxmyrtle
 PANICUM - Switchgrass
 ROSA - Drift Roses
- INSTALLATION SIZE WILL VARY:
 24\"-30\" ht for larger shrubs
 12\"-15\" ht for low growing / spreading shrubs

- LANDSCAPE BUFFER PLANTINGS IN DUKE ENERGY EASEMENT WILL INCLUDE A SELECTION FROM:
- UNDERSTORY TREES:**
 AMELANCHEIR CANADENSIS - Serviceberry
 CHIONANTHUS VIRGINICUS - Fringe Tree
 HAMAMELIS VERNALIS - Vernal Witch Hazel
 ILEX CORNUTA 'Steads' - Steeds Holly
 MAGNOLIA STELLATA - Star Magnolia
 MAGNOLIA GRANDIFLOR 'Little Gem' - Little Gem Magnolia
 VITEX AGNUS-CASTUS - Chaste Tree
- INSTALLATION SIZE WILL BE MIN 6\" HEIGHT
- SHRUBS/GROUNDCOVER:**
 ABELIA X GRANDIFLORA - Glossy Abelia
 BUXUS - Boxwood varieties
 CAMELLIA JAPONICA - Japanese Camellia
 CALLICARPA AMERICANA - American Beautyberry
 CEPHALOTAXUS HARRINGTONIA 'Fastigata' - Upright Plum Yew
 ILEX GLABRA - Inkberry
 ILLICIAM PARVIFLORUM - Anise
 MYRICA CERIFERA - Southern Waxmyrtle
- INSTALLATION SIZE: 24\"-36\" ht
- PARKING LOT PLANTINGS WILL INCLUDE A SELECTION FROM:**
- CANOPY TREES:**
 ACER RUBRUM 'October Glory' - October Glory Red Maple
 CARPINUS BETULUS 'Fastigata' - Columnar Hornbeam
 ULMUS PARVIFOLIA - Chinese Elm
 ZELKOVA SERRATA 'Village Green' - Village Green Zelkova
- INSTALLATION SIZE WILL BE MIN. 2 1/2\" CALIBER
- SHRUBS/GROUNDCOVER:**
 ILEX - Small hollies
 JUNIPERUS SARGENTII - Low growing Juniper
 LOROPETALUM CHINENSIS - low growing varieties Loropetalum
 MUHLENBERGIA CAPILLARIS - Pink Muhly Grass
 PANICUM VIRGATUM 'Shenandoah' - Shenandoah Switchgrass
- INSTALLATION SIZE WILL VARY
 18\"-30\" ht for large shrubs, 12\"-15\" ht for small/spreading shrubs

4 PLANT LIST
L-1.0

TREE COVERAGE CALCULATIONS

NET LAND AREA:
 = 78,557 SF

LESS OVERHEAD UTILITY EASEMENT OF 9,399 SF
 LESS ANTICIPATED STORM EASEMENT OF 11,801 SF
 LESS ANTICIPATED SANITARY SEWER EASEMENT OF 1,622 SF
 LESS ANTICIPATED WATER EASEMENT OF 987 F

NET SITE SIZE = 54,748 SF

REQUIRED TREE COVERAGE
 30% OF SITE = 16,424 SF

PROVIDED TREE COVERAGE:
 NO EXISTING CANOPY COVERAGE RETAINED
 33 NEW CANOPY TREES
 FOR 16,500 SF COVERAGE CREDIT

5 TREE COVERAGE SUMMARY
L-1.0

1 LANDSCAPE PLAN
L-1.0 1\" = 30\"

Project:
11SIXTY5
Weaver Dairy Road
 1165 Weaver Dairy Rd.
 Chapel Hill, NC 27514

PIN:
 9880350595



NOT ISSUED FOR CONSTRUCTION

Job Number: 1529

Drawn	WLR, MTC, VJC
Checked	WLR, VJC
Date	11-30-17
Revisions	1-25-18
	TRT COMMENT REVISIONS
	2-22-18
	TOWN COMMENT REVISIONS

SPECIAL USE PERMIT

Sheet Title:

LANDSCAPE AND TREE CANOPY PLAN

Sheet Number
L-1.0

FOR REFERENCE ONLY

ALL STRUCTURED PARKING INFORMATION SHOWN IS IN PRELIMINARY DESIGN AND IS SUBJECT TO CHANGE BASED ON REQUIREMENTS OF THE NCSBC, BUILDING OWNER REQUESTS, AND FUTURE TENANT NEEDS.

STRUCTURED PARKING INFORMATION:

STANDARD PARKING SPACES:	215 SPACES
VAN ACCESSIBLE PARKING SPACES:	5 SPACES
STANDARD ACCESSIBLE PARKING SPACES:	8 SPACES
ELECTRIC VEHICLE PARKING SPACES:	3 SPACES
STANDARD BICYCLE STORAGE:	5 RACKS 10 SPACES
LOCKED BICYCLE STORAGE:	12 LOCKERS
MOTORCYCLE PARKING SPACES:	41 SPACES

- GENERAL NOTES:**
- FLOOR PLANS AND ELEVATIONS AS SHOWN ARE SUBJECT TO REVISIONS BASED ON COMMENTS AND REQUESTS FROM THE TOWN OF CHAPEL HILL AS A PART OF THE SPECIAL USE PERMIT PROCESS.
 - FLOOR PLANS AND ELEVATIONS AS SHOWN ARE SUBJECT TO REVISION BASED ON COSTING EXERCISES.
 - PROTECT AREA OF WORK AND ADJACENT AREAS FROM DAMAGE.
 - DO NOT SCALE DRAWINGS. WRITTEN DIMENSIONS GOVERN. IN CASE OF CONFLICT, CONSULT THE ARCHITECT FOR DIRECTION.
 - INTERIOR PARTITIONS ARE DIMENSIONED FROM FINISH FACE TO FINISH FACE. UNLESS OTHERWISE NOTED, MAINTAIN DIMENSIONS MARKED "CLEAR". ALLOW FOR THICKNESS OF FINISHED WALL MATERIAL WHEN LAYING OUT WALLS. REFER TO INTERIOR FINISH INFORMATION FOR WALL FINISH.
 - ALL INTERIOR DOORS TO BE LOCATED 6" OFF PERPENDICULAR WALL, UNO. DIMENSION TO INCLUDE INTERIOR FINISH MATERIALS. ALL DOOR CLEARANCES TO MEET ANSI A117.1 2009 ACCESSIBLE CLEARANCES.
 - REFER TO THE OWNER FURNISHED OWNER INSTALLED LIST FOR EQUIPMENT TO BE INSTALLED BY OWNER'S CONTRACTOR. PROVIDE CONCEALED BLOCKING AS REQUIRED FOR WORK BY OWNER'S OTHER CONTRACTORS. COORDINATE WITH THE OWNER'S OTHER CONTRACTORS THE SIZE, LOCATION, AND BLOCKING REQUIREMENTS.
 - PLUMBING AND ELECTRICAL UTILITY SERVICES SHOWN IN THE P AND E SERIES ONLY EXTENDS 5'-0" OUTSIDE OF THE BUILDING. GC RESPONSIBLE FOR FINAL COORDINATION OF THESE ELEMENTS IF SITE CONDITIONS VARY FROM THE CIVIL / LANDSCAPE DESIGN DOCUMENTS. NOTIFY ARCHITECT WITH ANY DISCREPANCIES OR ALTERATIONS TO THE DESIGN DOCUMENTS THAT RESULT FROM SITE CONDITIONS.
 - REFER TO CIVIL / LANDSCAPE DRAWINGS FOR FINAL GRADE ELEVATIONS AROUND BUILDING. FINISH GRADE TO BE A MINIMUM OF 6" BELOW FINISH FLOOR LEVEL UNLESS NOTED OTHERWISE.

- DRAWING REFERENCES:**
- REFER TO G006 FOR TYPICAL INTERIOR MOUNTING HEIGHTS FOR TOILET ROOM ACCESSORIES, ELECTRICAL OUTLETS, DATA OUTLETS, FIRE ALARM, FIRE STROBE, THERMOSTATS, ETC.
 - REFER TO SHEET G200 FOR EXTERIOR WALL TYPE INFORMATION.
 - REFER TO SHEET G210 FOR INTERIOR WALL TYPE INFORMATION, UNLESS NOTED OTHERWISE, ALL INTERIOR WALLS TO BE B1.

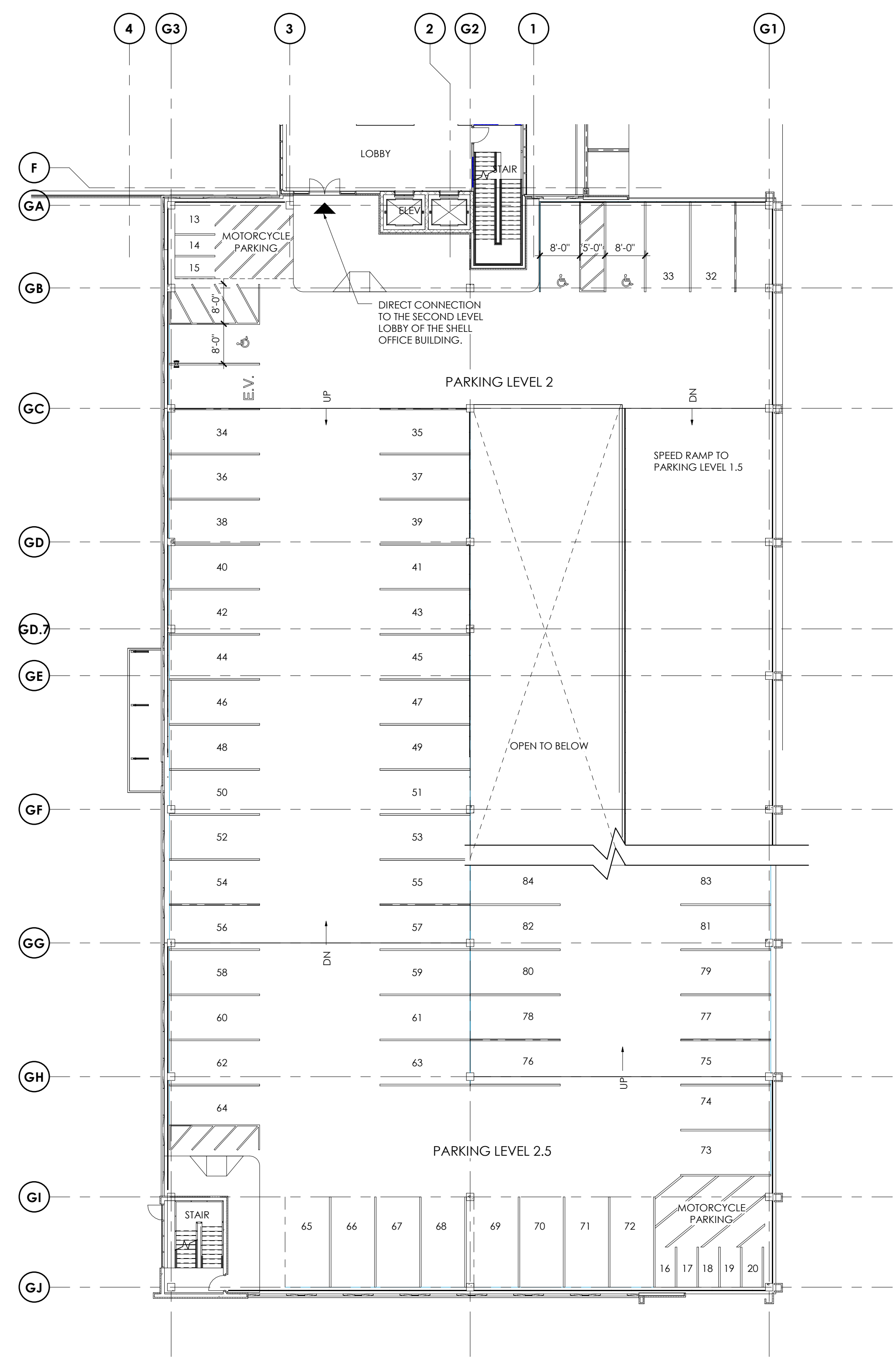

FLOOR PLAN - PARKING LEVEL 2
1/16" = 1'-0" **2**

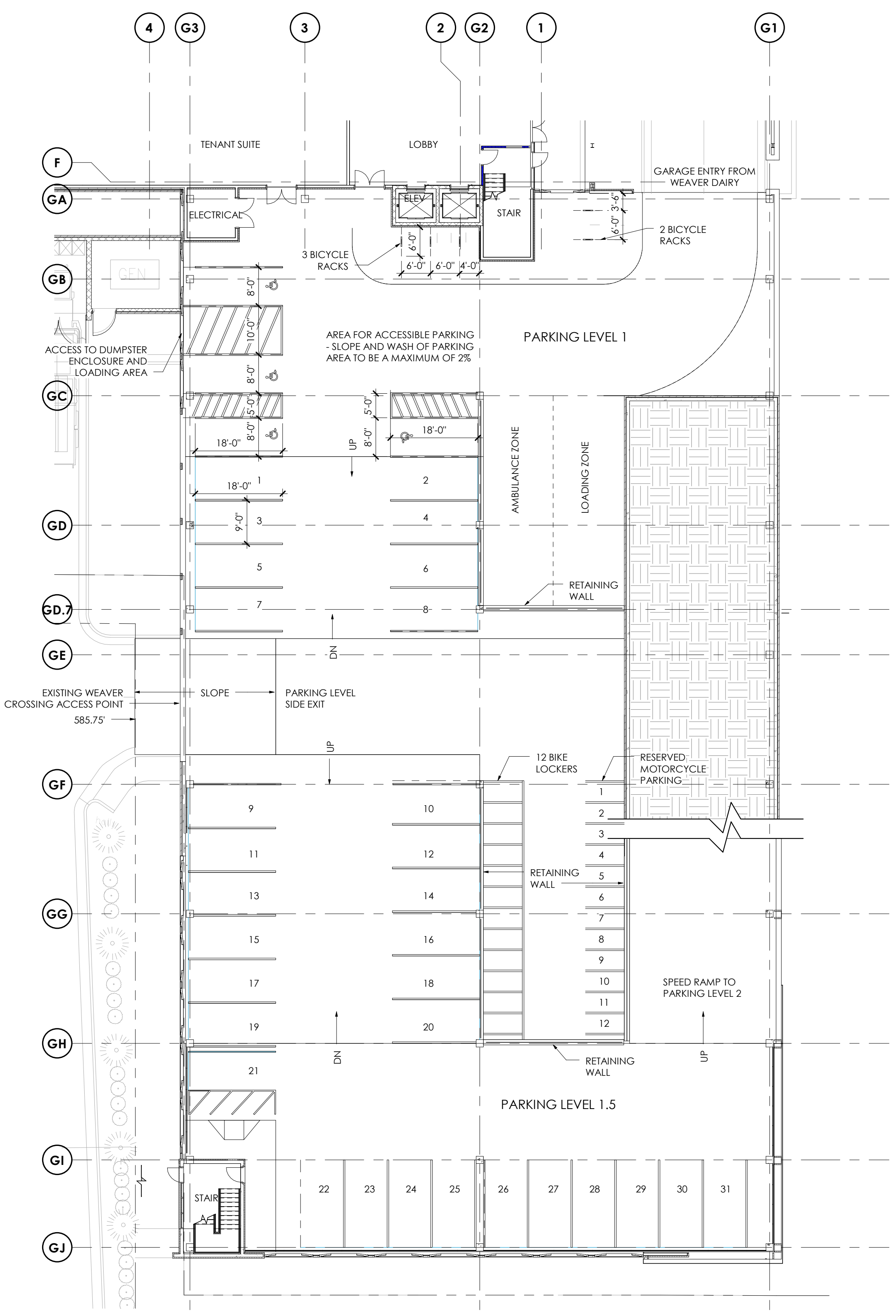

FLOOR PLAN - PARKING LEVEL 1
1/16" = 1'-0" **1**

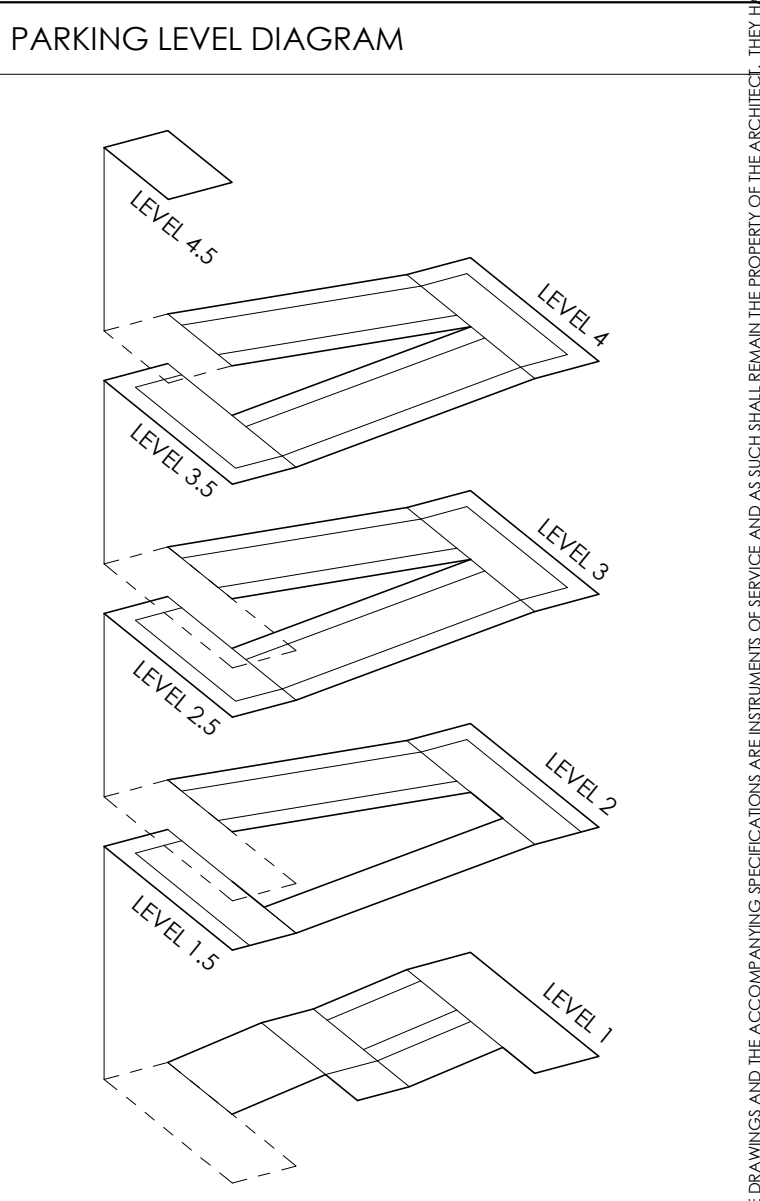

Coulter Jewell Thames

111 West Main Street
Durham, N.C. 27701
p 919.682.0368
f 919.688.5646
www.cjtpa.com

NC BOARD OF EXAMINERS FOR ENGINEERS AND SURVEYORS
LIC # C-1209
NC BOARD OF LANDSCAPE ARCHITECTS LIC # C-104

MHAworks

INTERIORS ARCHITECTURE

501 WASHINGTON STREET, SUITE G
DURHAM, NORTH CAROLINA 27701
p 919.682.2870
f 919.682.5369
www.mhainc.com

Project:

11SIXTY5 WEAVER DAIRY

SHELL OFFICE BUILDING
1165 WEAVER DAIRY
CHAPEL HILL, NC

PIN:
9880350595

NOT ISSUED FOR CONSTRUCTION

Job Number: 15060

Drawn	SAL
Checked	
Date	01/25/18
Revisions	

SPECIAL USE PERMIT

Sheet Title:
FLOOR PLANS - PARKING LEVELS 1 & 2

Sheet Number
A101D

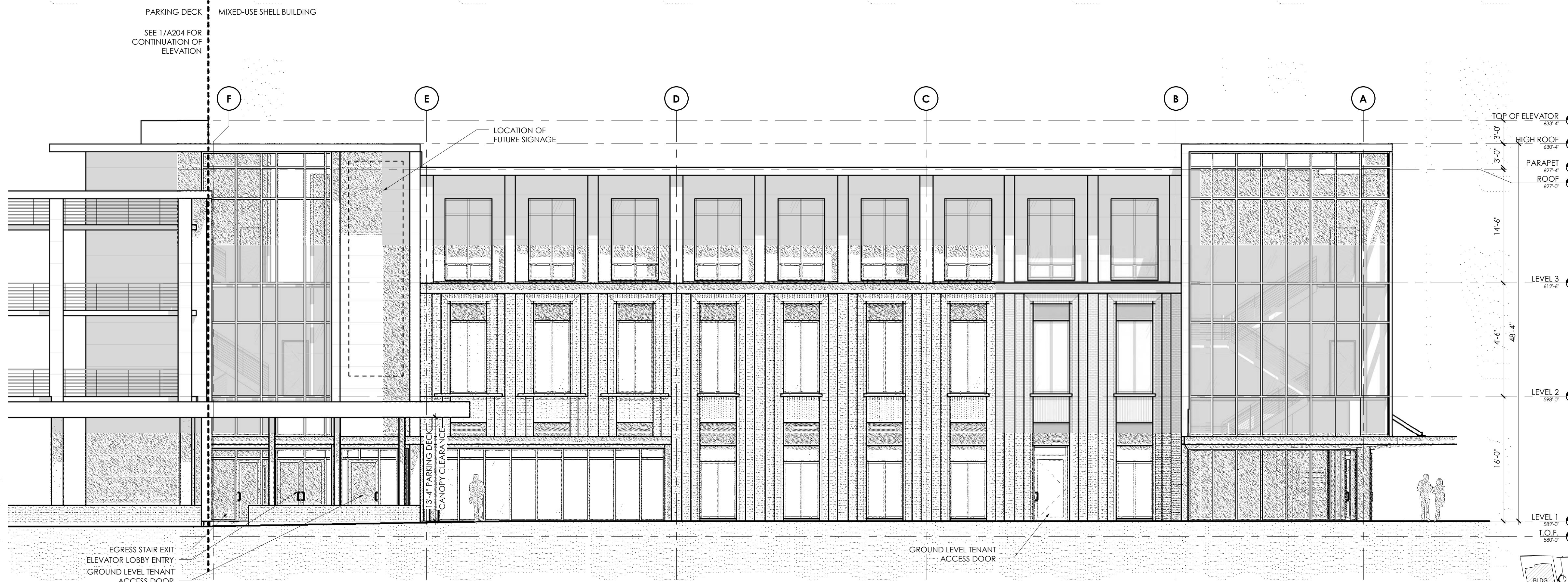

EAST ELEVATION ②
SITE ACCESS DRIVE ELEVATION: 1'-0"



NORTH ELEVATION ①
WEAVER DAIRY ELEVATION: 1'-0"

GENERAL NOTES:

1. FLOOR PLANS AND ELEVATIONS AS SHOWN ARE SUBJECT TO REVISIONS BASED ON COMMENTS AND REQUESTS FROM THE TOWN OF CHAPEL HILL AS A PART OF THE SPECIAL USE PERMIT PROCESS.
2. FLOOR PLANS AND ELEVATIONS AS SHOWN ARE SUBJECT TO REVISION BASED ON COSTING EXERCISES.
3. PROTECT AREA OF WORK AND ADJACENT AREAS FROM DAMAGE.
4. DO NOT SCALE DRAWINGS. WRITTEN DIMENSIONS GOVERN. IN CASE OF CONFLICT, CONSULT THE ARCHITECT FOR DIRECTION.
5. INTERIOR PARTITIONS ARE DIMENSIONED FROM FINISH FACE TO FINISH FACE UNLESS OTHERWISE NOTED. MAINTAIN DIMENSIONS MARKED "CLEAR". ALLOW FOR THICKNESS OF FINISHED WALL MATERIAL WHEN LAYING OUT WALLS. REFER TO INTERIOR FINISH INFORMATION FOR WALL FINISH.
6. ALL INTERIOR DOORS TO BE LOCATED 4" OFF PERPENDICULAR WALL, UNO. DIMENSION TO INCLUDE INTERIOR FINISH MATERIALS. ALL DOOR CLEARANCES TO MEET ANSI A117.1 2009 ACCESSIBLE CLEARANCES.
7. REFER TO THE OWNER FURNISHED OWNER INSTALLED LIST FOR EQUIPMENT TO BE INSTALLED BY OWNER'S CONTRACTOR. PROVIDE CONCEALED BLOCKING AS REQUIRED FOR WORK BY OWNER'S OTHER CONTRACTORS. COORDINATE WITH THE OWNER'S CONTRACTORS THE SIZE, LOCATION, AND BLOCKING REQUIREMENTS.
8. PLUMBING AND ELECTRICAL UTILITY SERVICES SHOWN IN THE P AND E SERIES ONLY EXTENDS 5'-0" OUTSIDE OF THE BUILDING. GC RESPONSIBLE FOR FINAL COORDINATION OF THESE ELEMENTS IF SITE CONDITIONS VARY FROM THE CIVIL / LANDSCAPE DESIGN DOCUMENTS. NOTIFY ARCHITECT WITH ANY DISCREPANCIES OR ALTERATIONS TO THE DESIGN DOCUMENTS THAT RESULT FROM SITE CONDITIONS.
9. REFER TO CIVIL / LANDSCAPE DRAWINGS FOR FINAL GRADE ELEVATIONS AROUND BUILDING. FINISH GRADE TO BE A MINIMUM OF 4" BELOW FINISH FLOOR LEVEL UNLESS NOTED OTHERWISE.

DRAWING REFERENCES:

1. REFER TO G006 FOR TYPICAL INTERIOR MOUNTING HEIGHTS FOR TOILET ROOM ACCESSORIES, ELECTRICAL OUTLETS, DATA OUTLETS, FIRE ALARMS, FIRE SMOKE, THERMOSTATS, ETC.
2. REFER TO SHEET G200 FOR EXTERIOR WALL TYPE INFORMATION.
3. REFER TO SHEET G210 FOR INTERIOR WALL TYPE INFORMATION, UNLESS NOTED OTHERWISE. ALL INTERIOR WALLS TO BE B1.

DESIGN NARRATIVE

THE DESIGN INTENT FOR MATERIAL EXPRESSION IS BRICK VENEER ON LEVEL 1 & 2, AND AN ALTERNATE MATERIAL (METAL PANEL/EIPS) ON LEVEL 3, WITH LARGE AREAS OF GLAZING BREAKING UP THE ELEVATIONS TO SIGNIFY MOVEMENT AND ENTRY.

ToCH BLDG HGT REQ'S - OI-3

TABLE 3.8-1 - DIMENSIONAL MATRIX (4/20/2017)

ZONING DISTRICT	PRIMARY HEIGHT	SECONDARY HEIGHT	STREET SETBACK	INTERIOR SETBACK	SOLAR SETBACK
OI-3	N/A	N/A	0'	0'	0'

NOTE: DUE TO THE BUILDING HEIGHT AND SOLAR SETBACK REQUIREMENTS BEING N/A AND 0, THIS INFORMATION HAS NOT BEEN INCLUDED ON THE EXTERIOR ELEVATIONS AS IT HAS NO BEARING ON THE OVERALL BUILDING DESIGN.

FINISH LEGEND - EXTERIOR MATERIALS

- UM1**
04 2000 UNIT MASONRY
MATERIAL: CLAY MASONRY UNIT
SIZE: MODULAR UNIT
FINISH: SMOOTH
NOTE: PRIMARY FIELD BRICK
- UM2**
04 2000 UNIT MASONRY
MATERIAL: CLAY MASONRY UNIT
SIZE: MODULAR UNIT
FINISH: SMOOTH
STACK BOND
NOTE: SECONDARY COLOR
- MP1**
07 4213.2 METAL COMPOSITE MATERIAL
DESCRIPTION: Metal Composite Metal
TYPE: Fire Retardant Core
SIZE: Refer to Sections and Elevations
THICKNESS: 0.157" Material, 2" Panel
STYLE: Route and Return
- CW1**
08 4413 Glazed Aluminum Curtain Wall
MANUFACTURER: OLDCASTLE BUILDING ENVELOPE
TYPE: RELIANCE-SS CASSETTE
SIZE: 2 1/2" x 8"
NOTE: REFER TO ELEVATIONS FOR GLAZING TYPE
- ES1**
08 4113 Entrances and Storefronts
MANUFACTURER: OLDCASTLE BUILDING ENVELOPE
TYPE: SERIES 3000 THERMAL MULTIPLANE
SIZE: 2' x 4 1/2'
STYLE: FRONT SET - 1" GLAZING
NOTE: REFER TO ELEVATIONS FOR GLAZING TYPE
- GL1**
08 8000 Glazing
DESCRIPTION: Heat Strengthened Insulated Glass
MANUFACTURER: Guardian
TYPE: SunGuard SNX 51/23
SIZE: 1" Unit Width
NOTE: Temper as indicated on Elevations
- GL1***
08 8000 Glazing
DESCRIPTION: Heat Strengthened Insulated Glass
MANUFACTURER: Guardian
TYPE: SunGuard SNX 51/23
SIZE: 1" Unit Width
Apply Translucent Film on Surface 4
NOTE: Temper as indicated on Elevations

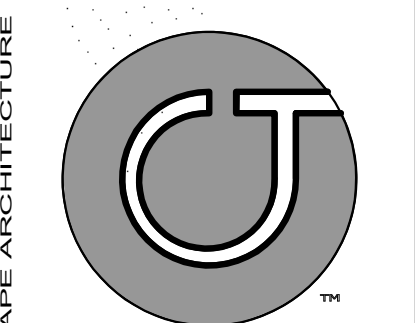

Coulter Jewell Thames
111 West Main Street
Durham, N.C. 27701
p 919.682.0368
f 919.688.5646
www.cjtpa.com

NC BOARD OF EXAMINERS FOR ENGINEERS AND SURVEYORS
LIC # C-1209
NC BOARD OF LANDSCAPE ARCHITECTS LIC # C-104

MHAworks
PLANNING ARCHITECTURE INTERIORS
501 WASHINGTON STREET, SUITE G
DURHAM, NORTH CAROLINA 27701
P 919.682.2870
F 919.682.2369
www.mhaworks.com

Project:
11SIXTY5 WEAVER DAIRY

SHELL OFFICE BUILDING
1165 WEAVER DAIRY
CHAPEL HILL, NC

PIN:
9880350595

NOT ISSUED FOR CONSTRUCTION

Job Number: 15060

Drawn	SAL
Checked	
Date	01/25/18
Revisions	

SPECIAL USE PERMIT

Sheet Title:
BUILDING ELEVATIONS

Sheet Number
A200

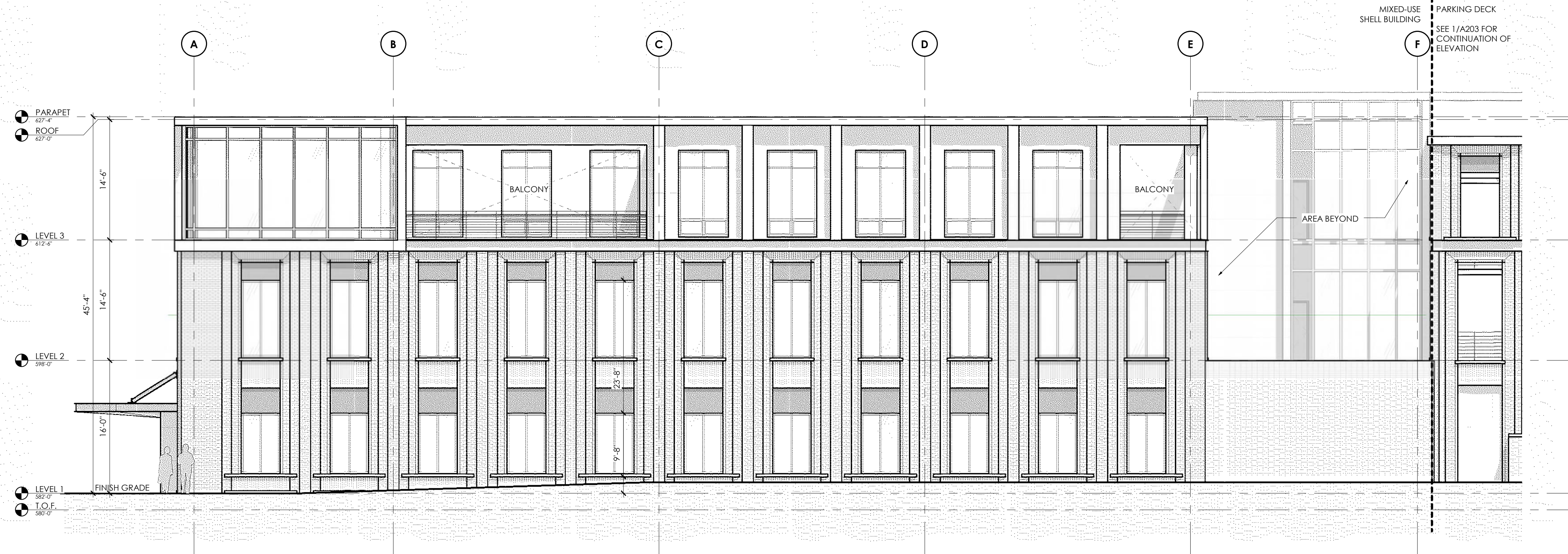

WEST ELEVATION
ELEVATION FACING WEAVER CROSSING

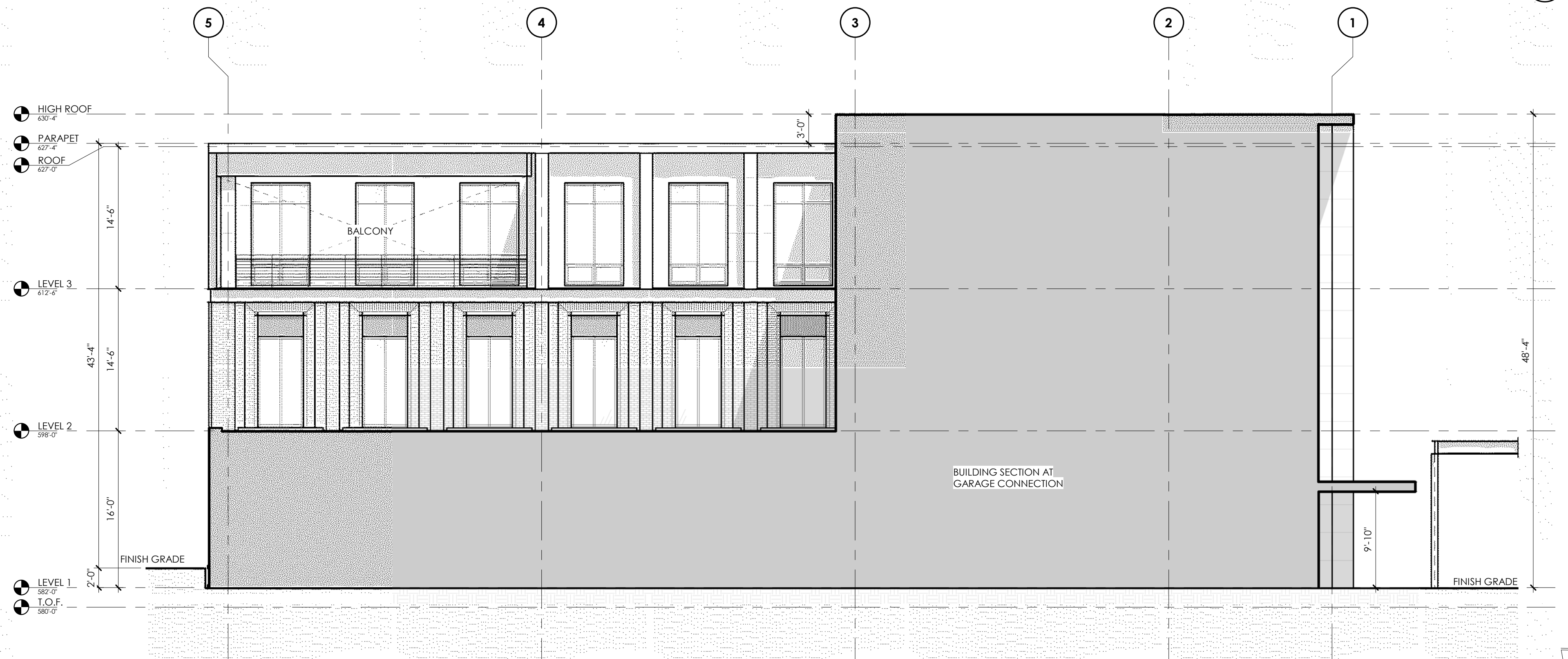

SOUTH ELEVATION
ELEVATION FACING PARKING DECK

GENERAL NOTES:

1. FLOOR PLANS AND ELEVATIONS AS SHOWN ARE SUBJECT TO REVISIONS BASED ON COMMENTS AND REQUESTS FROM THE TOWN OF CHAPEL HILL AS A PART OF THE SPECIAL USE PERMIT PROCESS.
2. FLOOR PLANS AND ELEVATIONS AS SHOWN ARE SUBJECT TO REVISION BASED ON COSTING EXERCISES.
3. PROTECT AREA OF WORK AND ADJACENT AREAS FROM DAMAGE.
4. DO NOT SCALE DRAWINGS. WRITTEN DIMENSIONS GOVERN. IN CASE OF CONFLICT, CONSULT THE ARCHITECT FOR DIRECTION.
5. INTERIOR PARTITIONS ARE DIMENSIONED FROM FINISH FACE TO FINISH FACE. UNLESS OTHERWISE NOTED, MAINTAIN DIMENSIONS MARKED "CLEAR". ALLOW FOR THICKNESS OF FINISHED WALL MATERIAL WHEN LAYING OUT WALLS. REFER TO INTERIOR FINISH INFORMATION FOR WALL FINISH.
6. ALL INTERIOR DOORS TO BE LOCATED 4" OFF PERPENDICULAR WALL. UNO. DIMENSION TO INCLUDE INTERIOR FINISH MATERIALS. ALL DOOR CLEARANCES TO MEET ANSI A117.1 2009 ACCESSIBLE CLEARANCES.
7. REFER TO THE OWNER FURNISHED OWNER INSTALLED LIST FOR EQUIPMENT TO BE INSTALLED BY OWNER'S CONTRACTOR. PROVIDE CONCEALED BLOCKING AS REQUIRED FOR WORK BY OWNER'S OTHER CONTRACTORS. COORDINATE WITH THE OWNER'S CONTRACTORS THE SIZE, LOCATION, AND BLOCKING REQUIREMENTS.
8. PLUMBING AND ELECTRICAL UTILITY SERVICES SHOWN IN THE P AND E SERIES ONLY EXTENDS 5'-0" OUTSIDE OF THE BUILDING. GC RESPONSIBLE FOR FINAL COORDINATION OF THESE ELEMENTS IF SITE CONDITIONS VARY FROM THE CIVIL / LANDSCAPE DESIGN DOCUMENTS. NOTIFY ARCHITECT WITH ANY DISCREPANCIES OR ALTERATIONS TO THE DESIGN DOCUMENTS THAT RESULT FROM SITE CONDITIONS.
9. REFER TO CIVIL / LANDSCAPE DRAWINGS FOR FINAL GRADE ELEVATIONS AROUND BUILDING. FINISH GRADE TO BE A MINIMUM OF 4" BELOW FINISH FLOOR LEVEL UNLESS NOTED OTHERWISE.

DRAWING REFERENCES:

1. REFER TO G006 FOR TYPICAL INTERIOR MOUNTING HEIGHTS FOR TOILET ROOM ACCESSORIES, ELECTRICAL OUTLETS, DATA OUTLETS, FIRE ALARMS, FIRE STROBE, THERMOSTATS, ETC.
2. REFER TO SHEET G200 FOR EXTERIOR WALL TYPE INFORMATION.
3. REFER TO SHEET G210 FOR INTERIOR WALL TYPE INFORMATION, UNLESS NOTED OTHERWISE. ALL INTERIOR WALLS TO BE B1.

DESIGN NARRATIVE

THE DESIGN INTENT FOR MATERIAL EXPRESSION IS BRICK VENEER ON LEVEL 1 & 2, AND AN ALTERNATE MATERIAL (METAL PANEL/EIFS) ON LEVEL 3, WITH LARGE AREAS OF GLAZING BREAKING UP THE ELEVATIONS TO SIGNIFY MOVEMENT AND ENTRY.

ToCH BLDG HGT REQ'S - OI-3

TABLE 3.8-1 - DIMENSIONAL MATRIX (4/20/2017)

ZONING DISTRICT	(F) PRIMARY HEIGHT	(G) SECONDARY HEIGHT	(H) STREET SETBACK	(I) INTERIOR SETBACK	(J) SOLAR SETBACK
OI-3	N/A	N/A	0'	0'	0'

NOTE: DUE TO THE BUILDING HEIGHT AND SOLAR SETBACK REQUIREMENTS BEING N/A AND 0, THIS INFORMATION HAS NOT BEEN INCLUDED ON THE EXTERIOR ELEVATIONS AS IT HAS NO BEARING ON THE OVERALL BUILDING DESIGN.

FINISH LEGEND - EXTERIOR MATERIALS

- UM1**
04 2000 UNIT MASONRY
MATERIAL: CLAY MASONRY UNIT
SIZE: MODULAR UNIT
FINISH: SMOOTH
NOTE: PRIMARY FIELD BRICK
- UM2**
04 2000 UNIT MASONRY
MATERIAL: CLAY MASONRY UNIT
SIZE: MODULAR UNIT
FINISH: SMOOTH
STACK BOND
NOTE: SECONDARY COLOR
- MP1**
07 4213.23 METAL COMPOSITE MATERIAL
DESCRIPTION: Metal Composite Metal
TYPE: Fire Retardant Core
SIZE: Refer to Sections and Elevations
THICKNESS: 0.157" Material, 2" Panel
STYLE: Route and Return
- CW1**
08 4413 Glazed Aluminum Curtain Wall
MANUFACTURER: OLDCASTLE BUILDING ENVELOPE
TYPE: RELIANCE-SS CASSETTE
SIZE: 2 1/2" x 8"
NOTE: REFER TO ELEVATIONS FOR GLAZING TYPE
- ES1**
08 4113 Entrances and Storefronts
MANUFACTURER: OLDCASTLE BUILDING ENVELOPE
TYPE: SERIES 3000 THERMAL MULTIPLANE
SIZE: 2" x 4 1/2"
STYLE: FRONT SET - 1" GLAZING
NOTE: REFER TO ELEVATIONS FOR GLAZING TYPE
- GL1**
08 8000 Glazing
DESCRIPTION: Heat Strengthened Insulated Glass
MANUFACTURER: Guardian
TYPE: SunGuard SNX 51/23
SIZE: 1" Unit Width
NOTE: Temper as indicated on Elevations
- GL1***
08 8000 Glazing
DESCRIPTION: Heat Strengthened Insulated Glass
MANUFACTURER: Guardian
TYPE: SunGuard SNX 51/23
SIZE: 1" Unit Width
Apply Translucent Film on Surface 4
NOTE: Temper as indicated on Elevations

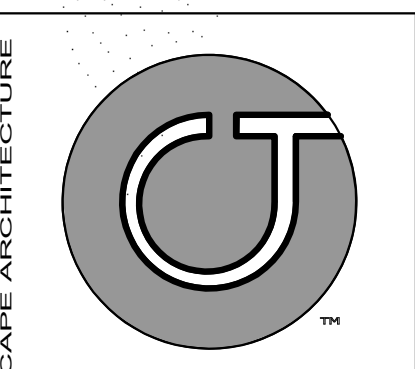

Coulter Jewell Thames
ARCHITECTURE

111 West Main Street
Durham, N.C. 27701
p 919.682.0368
f 919.688.5646
www.cjtpa.com

NC BOARD OF EXAMINERS FOR ENGINEERS AND SURVEYORS
LIC # C-1209
NC BOARD OF LANDSCAPE ARCHITECTS LIC # C-104

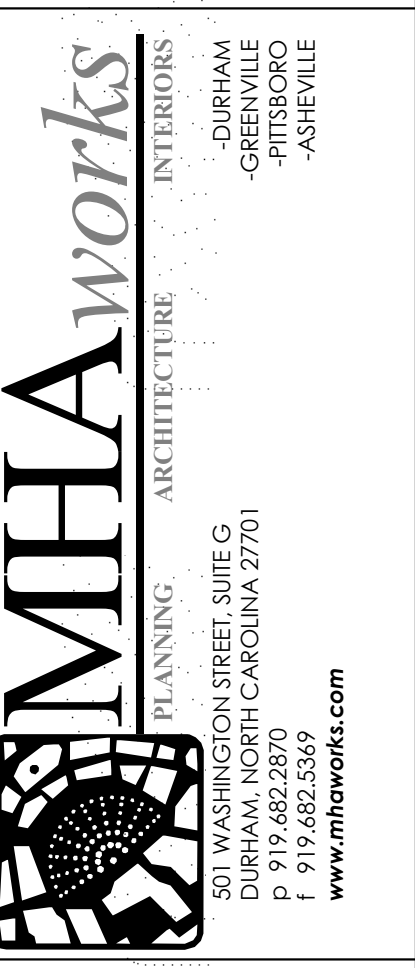

MHAworks
ARCHITECTURE
INTERIORS
501 WASHINGTON STREET, SUITE G
DURHAM, NORTH CAROLINA 27701
P 919.682.2870
F 919.682.5369
www.mhaworks.com

Project:
11SIXTY5 WEAVER DAIRY

SHELL OFFICE BUILDING
1165 WEAVER DAIRY
CHAPEL HILL, NC

PIN:
9880350595

NOT ISSUED FOR CONSTRUCTION

Job Number: 15060

Drawn	SAL
Checked	
Date	01/25/18
Revisions	

SPECIAL USE PERMIT

Sheet Title:
BUILDING ELEVATIONS

Sheet Number
A201



DECK ELEVATION - WEST
ELEVATION FACING WEAVER CROSSING 1/8" = 1'-0" 1

FINISH LEGEND - EXTERIOR MATERIALS

UM1
04 2000 UNIT MASONRY
MATERIAL: CLAY MASONRY UNIT
SIZE: MODULAR UNIT
FINISH: SMOOTH
NOTE: PRIMARY FIELD BRICK

UM2
04 2000 UNIT MASONRY
MATERIAL: CLAY MASONRY UNIT
SIZE: MODULAR UNIT
FINISH: SMOOTH
STACK BOND
NOTE: SECONDARY COLOR

MP1
07 4213.2 METAL COMPOSITE MATERIAL
DESCRIPTION: Metal Composite Metal
TYPE: Fire Retardant Core
SIZE: Refer to Sections and Elevations
THICKNESS: 0.137" Material, 2" Panel
STYLE: Route and Return

CW1
08 4413 Glazed Aluminum Curtain Wall
MANUFACTURER: OLDCASTLE BUILDING
ENVELOPE
TYPE: RELIANCE-SS CASSETTE
SIZE: 2 1/2" x 8"
NOTE: REFER TO ELEVATIONS FOR GLAZING TYPE

ES1
08 4113 Entrances and Storefronts
MANUFACTURER: OLDCASTLE BUILDING
ENVELOPE
TYPE: SERIES 3000 THERMAL MULTIPLANE
SIZE: 2' x 4 1/2"
STYLE: FRONT SET - 1" GLAZING
NOTE: REFER TO ELEVATIONS FOR GLAZING TYPE

GL1
08 8000 Glazing
DESCRIPTION: Heat Strengthened Insulated Glass
MANUFACTURER: Guardian
TYPE: SunGuard SNX 51/23
SIZE: 1" Unit Width
NOTE: Temper as indicated on Elevations

GL1*
08 8000 Glazing
DESCRIPTION: Heat Strengthened Insulated Glass
MANUFACTURER: Guardian
TYPE: SunGuard SNX 51/23
SIZE: 1" Unit Width
Apply translucent Film on Surface 4
NOTE: Temper as indicated on Elevations

DESIGN NARRATIVE

THE DESIGN INTENT FOR MATERIAL EXPRESSION IS BRICK VENEER ON LEVEL 1 & 2, AND AN ALTERNATE MATERIAL (METAL PANEL/EIFS) ON LEVEL 3, WITH LARGE AREAS OF GLAZING BREAKING UP THE ELEVATIONS TO SIGNIFY MOVEMENT AND ENTRY.

ToCH BLDG HGT REQ'S - OI-3

TABLE 3.8-1 - DIMENSIONAL MATRIX (4/20/2017)					
ZONING DISTRICT	(F)	(G)	(H)	(I)	(J)
OI-3	N/A	N/A	0'	0'	0'

NOTE: DUE TO THE BUILDING HEIGHT AND SOLAR SETBACK REQUIREMENTS BEING N/A AND 0, THIS INFORMATION HAS NOT BEEN INCLUDED ON THE EXTERIOR ELEVATIONS AS IT HAS NO BEARING ON THE OVERALL BUILDING DESIGN.

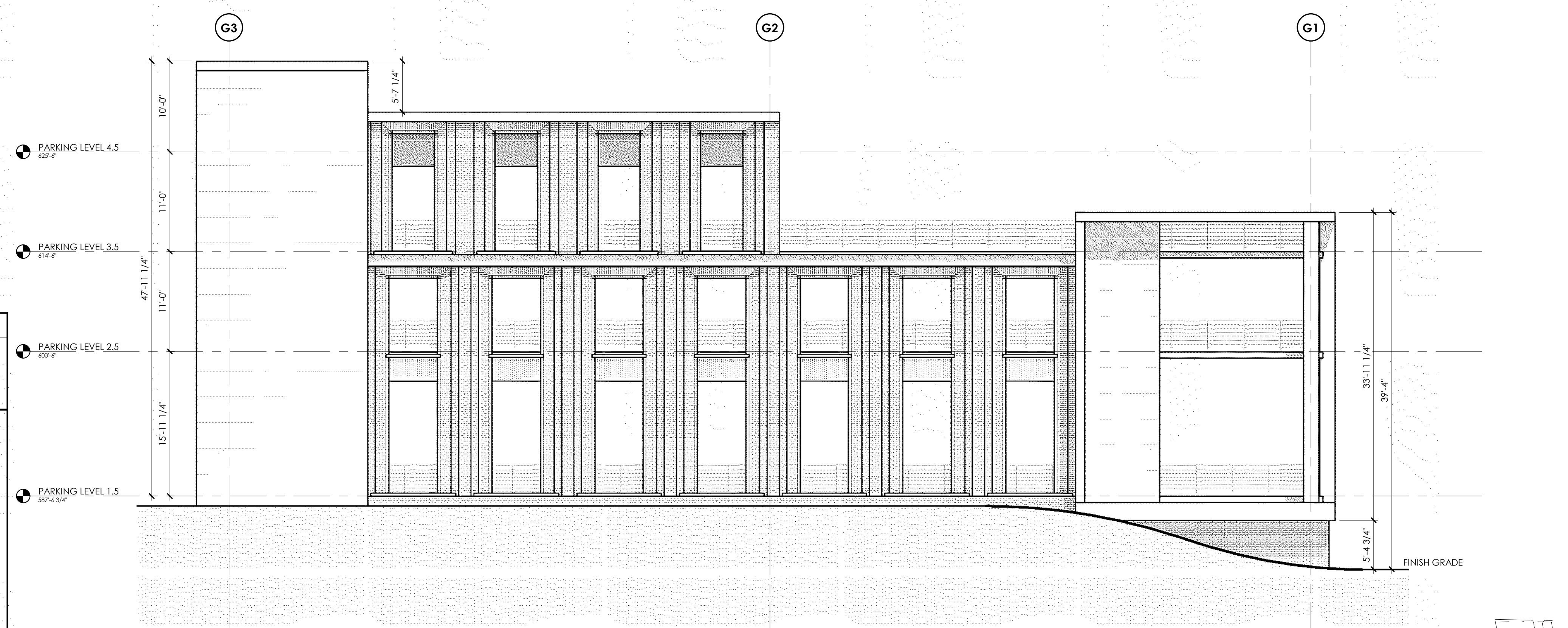

DECK ELEVATION - SOUTH
1/8" = 1'-0" 2

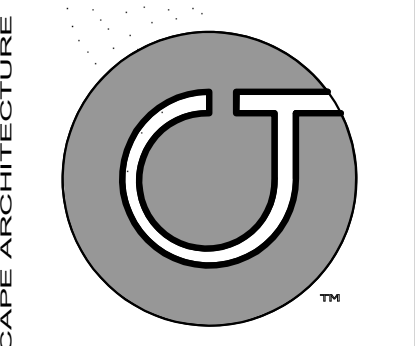

Coulter Jewell Thames RA
111 West Main Street
Durham, N.C. 27701
p 919.682.0368
f 919.688.5646
www.cjtpa.com

NC BOARD OF EXAMINERS FOR ENGINEERS AND SURVEYORS
LIC # C-1209
NC BOARD OF LANDSCAPE ARCHITECTS LIC # C-104

MHAworks
ARCHITECTURE INTERIORS
501 WASHINGTON STREET, SUITE G
DURHAM, NORTH CAROLINA 27701
p 919.682.2870
f 919.682.5369
www.mhaworks.com

Project:
11SIXTY5 WEAVER DAIRY
SHELL OFFICE BUILDING
1165 WEAVER DAIRY
CHAPEL HILL, NC
PIN:
9880350595

NOT ISSUED FOR CONSTRUCTION
Job Number: 15060

Drawn	SAL
Checked	
Date	01/25/18
Revisions	

SPECIAL USE PERMIT
Sheet Title:
PARKING DECK ELEVATIONS

Sheet Number
A203

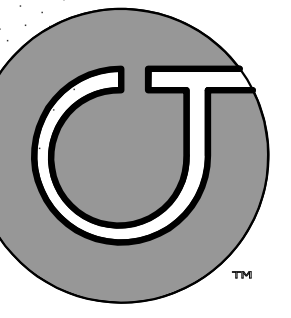

**Coulter
Jewell
Thames** P.A.

111 West Main Street
Durham, N.C. 27701
p 919.682.0368
f 919.688.5646
www.cjtpa.com

NC BOARD OF EXAMINERS FOR
ENGINEERS AND SURVEYORS
LIC # C-1209
NC BOARD OF LANDSCAPE
ARCHITECTS LIC # C-104

MHAworks
ARCHITECTURE
INTERIORS
-DURHAM
-GREENVILLE
-PITTSBORO
-ASHEVILLE

501 WASHINGTON STREET, SUITE G
DURHAM, NORTH CAROLINA 27701
p 919.682.2870
f 919.682.2369
www.mhaworks.com

Project:

**11SIXTY5
WEAVER
DAIRY**

SHELL OFFICE
BUILDING
1165 WEAVER DAIRY
CHAPEL HILL, NC

PN:
9880350595

NOT ISSUED FOR
CONSTRUCTION

Job Number: 15060

Drawn	SAL
Checked	
Date	01/25/18
Revisions	

SPECIAL USE PERMIT

Sheet Title:
**PARKING DECK
ELEVATIONS**

Sheet Number

A204

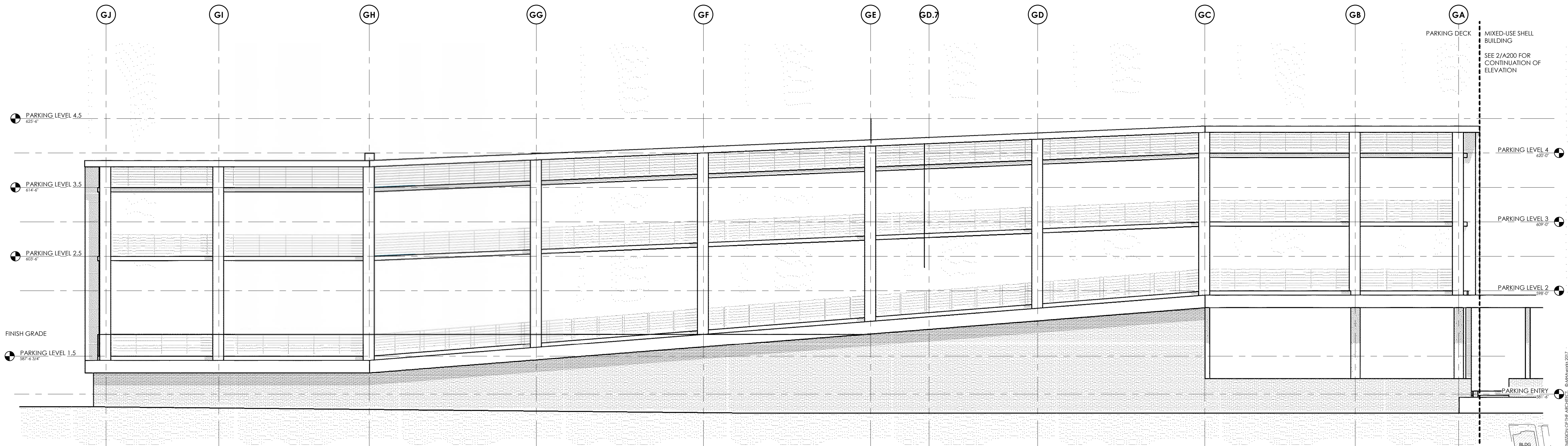

DECK ELEVATION - EAST 1
1/8" = 1'-0"

FINISH LEGEND - EXTERIOR MATERIALS

- UM1**
04 2000 UNIT MASONRY
MATERIAL: CLAY MASONRY UNIT
SIZE: MODULAR UNIT
FINISH: SMOOTH
NOTE: PRIMARY FIELD BRICK
- UM2**
04 2000 UNIT MASONRY
MATERIAL: CLAY MASONRY UNIT
SIZE: MODULAR UNIT
FINISH: SMOOTH
STACK BOND
NOTE: SECONDARY COLOR
- MP1**
07 4213.2 METAL COMPOSITE MATERIAL
DESCRIPTION: Metal Composite Metal
TYPE: Fire Retardant Core
SIZE: Refer to Sections and Elevations
THICKNESS: 0.157" Material, 2" Panel
STYLE: Route and Return
- CW1**
08 4413 Glazed Aluminum Curtain Wall
MANUFACTURER: OLDCASTLE BUILDING
ENVELOPE
TYPE: RELIANCE-SS CASSETTE
SIZE: 2 1/2" x 8"
NOTE: REFER TO ELEVATIONS FOR GLAZING TYPE
- ES1**
08 4113 Entrances and Storefronts
MANUFACTURER: OLDCASTLE BUILDING
ENVELOPE
TYPE: SERIES 3000 THERMAL MULTIPLANE
SIZE: 2' x 4 1/2"
STYLE: FRONT SET - 1" GLAZING
NOTE: REFER TO ELEVATIONS FOR GLAZING TYPE
- GL1**
08 8000 Glazing
DESCRIPTION: Heat Strengthened Insulated Glass
MANUFACTURER: Guardian
TYPE: SunGuard SHX 51/23
SIZE: 1" Unit Width
NOTE: Temper as indicated on Elevations
- GL1***
08 8000 Glazing
DESCRIPTION: Heat Strengthened Insulated Glass
MANUFACTURER: Guardian
TYPE: SunGuard SHX 51/23
SIZE: 1" Unit Width
Apply Translucent Film on Surface 4
NOTE: Temper as indicated on Elevations

DESIGN NARRATIVE

THE DESIGN INTENT FOR MATERIAL EXPRESSION IS BRICK VENEER ON LEVEL 1 & 2, AND AN ALTERNATE MATERIAL (METAL PANEL/EIFS) ON LEVEL 3, WITH LARGE AREAS OF GLAZING BREAKING UP THE ELEVATIONS TO SIGNIFY MOVEMENT AND ENTRY.

ToCH BLDG HGT REQ'S - OI-3

TABLE 3.8-1 - DIMENSIONAL MATRIX (4/20/2017)

ZONING DISTRICT	(F)	(G)	(H)	(I)	(J)
PRIMARY HEIGHT					
SECONDARY HEIGHT					
STREET SETBACK			0'	0'	0'
INTERIOR SETBACK					
SOLAR SETBACK					

NOTE: DUE TO THE BUILDING HEIGHT AND SOLAR SETBACK REQUIREMENTS BEING N/A AND 0, THIS INFORMATION HAS NOT BEEN INCLUDED ON THE EXTERIOR ELEVATIONS AS IT HAS NO BEARING ON THE OVERALL BUILDING DESIGN.

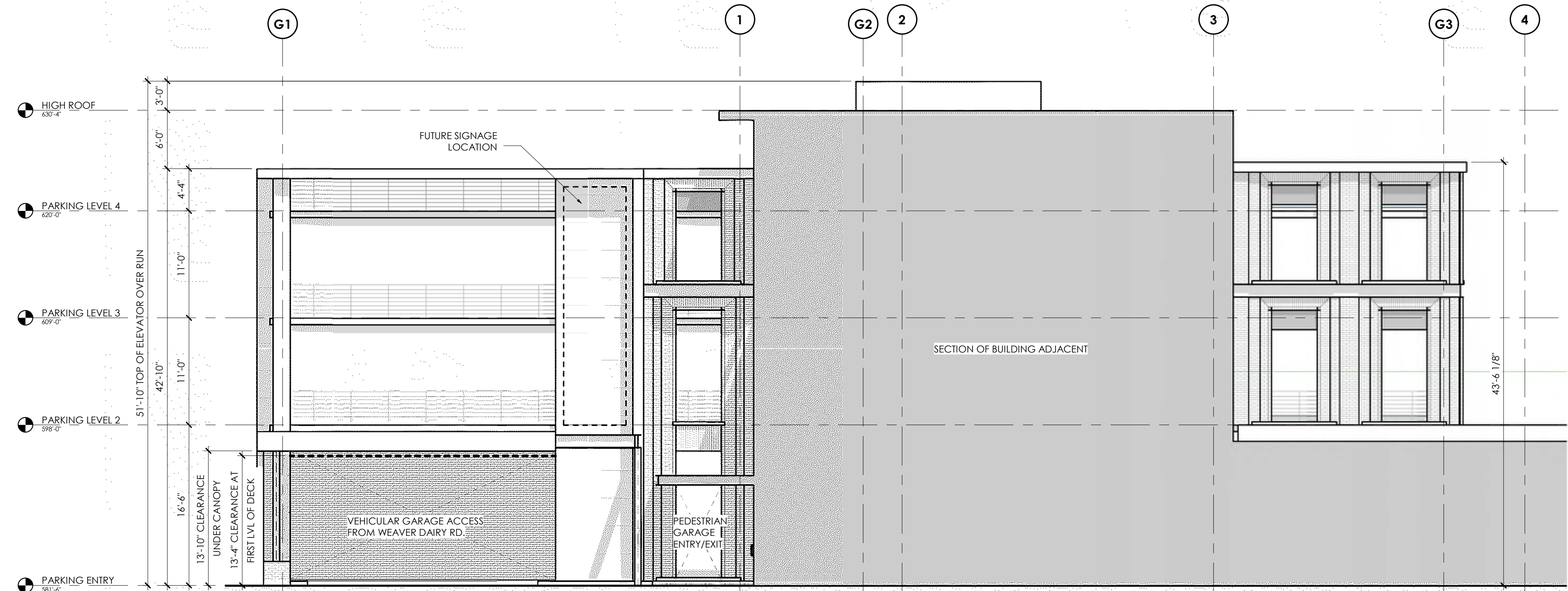

DECK ELEVATION - NORTH 2
1/8" = 1'-0"

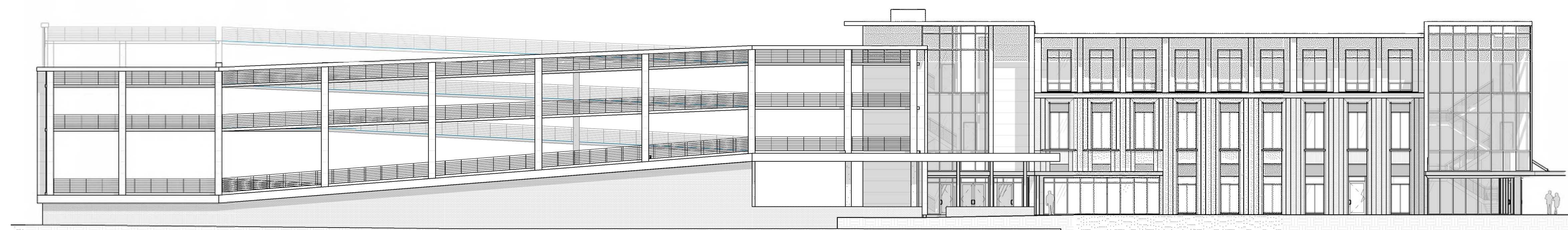

OVERALL EAST ELEVATION 2
1/16" = 1'-0"

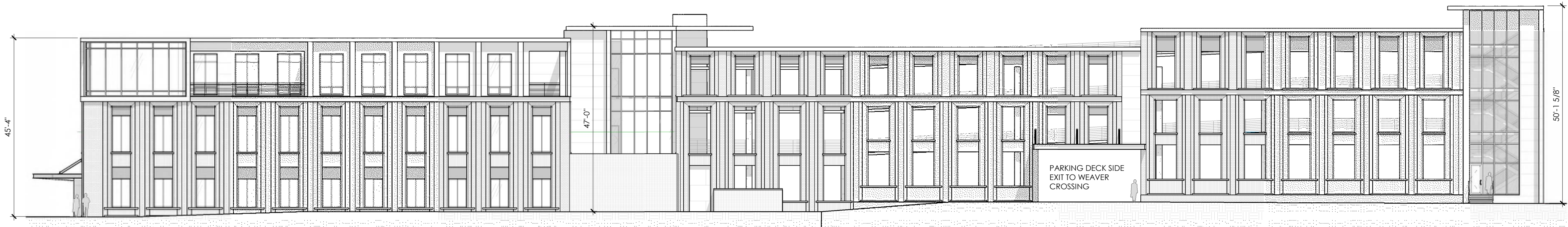

OVERALL WEST ELEVATION 1
1/16" = 1'-0"

GENERAL NOTES:

1. FLOOR PLANS AND ELEVATIONS AS SHOWN ARE SUBJECT TO REVISIONS BASED ON COMMENTS AND REQUESTS FROM THE TOWN OF CHAPEL HILL AS A PART OF THE SPECIAL USE PERMIT PROCESS.
2. FLOOR PLANS AND ELEVATIONS AS SHOWN ARE SUBJECT TO REVISION BASED ON COSTING EXERCISES.
3. PROTECT AREA OF WORK AND ADJACENT AREAS FROM DAMAGE.
4. DO NOT SCALE DRAWINGS. WRITTEN DIMENSIONS GOVERN. IN CASE OF CONFLICT, CONSULT THE ARCHITECT FOR DIRECTION.
5. INTERIOR PARTITIONS ARE DIMENSIONED FROM FINISH FACE TO FINISH FACE. UNLESS OTHERWISE NOTED, MAINTAIN DIMENSIONS MARKED "CLEAR". ALLOW FOR THICKNESS OF FINISHED WALL MATERIAL WHEN LAYING OUT WALLS. REFER TO INTERIOR FINISH INFORMATION FOR WALL FINISH.
6. ALL INTERIOR DOORS TO BE LOCATED 4" OFF PERPENDICULAR WALL, UNO. DIMENSION TO INCLUDE INTERIOR FINISH MATERIALS. ALL DOOR CLEARANCES TO MEET ANSI A117.1 2009 ACCESSIBLE CLEARANCES.
7. REFER TO THE OWNER FURNISHED OWNER INSTALLED LIST FOR EQUIPMENT TO BE INSTALLED BY OWNER'S CONTRACTOR. PROVIDE CONCEALED BLOCKING AS REQUIRED FOR WORK BY OWNER'S OTHER CONTRACTORS. COORDINATE WITH THE OWNER'S CONTRACTORS THE SIZE, LOCATION, AND BLOCKING REQUIREMENTS.
8. PLUMBING AND ELECTRICAL UTILITY SERVICES SHOWN IN THE P AND E SERIES ONLY EXTENDS 5'-0" OUTSIDE OF THE BUILDING. GC RESPONSIBLE FOR FINAL COORDINATION OF THESE ELEMENTS IF SITE CONDITIONS VARY FROM THE CIVIL / LANDSCAPE DESIGN DOCUMENTS. NOTIFY ARCHITECT WITH ANY DISCREPANCIES OR ALTERATIONS TO THE DESIGN DOCUMENTS THAT RESULT FROM SITE CONDITIONS.
9. REFER TO CIVIL / LANDSCAPE DRAWINGS FOR FINAL GRADE ELEVATIONS AROUND BUILDING. FINISH GRADE TO BE A MINIMUM OF 4" BELOW FINISH FLOOR LEVEL UNLESS NOTED OTHERWISE.

DRAWING REFERENCES:

1. REFER TO G006 FOR TYPICAL INTERIOR MOUNTING HEIGHTS FOR TOILET ROOM ACCESSORIES, ELECTRICAL OUTLETS, DATA OUTLETS, FIRE ALARM, FIRE STROBE, THERMOSTATS, ETC.
2. REFER TO SHEET G200 FOR EXTERIOR WALL TYPE INFORMATION.
3. REFER TO SHEET G210 FOR INTERIOR WALL TYPE INFORMATION, UNLESS NOTED OTHERWISE. ALL INTERIOR WALLS TO BE B1.

ToCH BLDG HGT REQ'S - OI-3

TABLE 3.8-1 - DIMENSIONAL MATRIX (4/20/2017)

ZONING DISTRICT	PRIMARY HEIGHT	SECONDARY HEIGHT	(F)	(G)	(H)	(I)	(J)
			STREET SETBACK	INTERIOR SETBACK	SOLAR SETBACK		
OI-3	N/A	N/A	0'	0'	0'		

NOTE: DUE TO THE BUILDING HEIGHT AND SOLAR SETBACK REQUIREMENTS BEING N/A AND 0, THIS INFORMATION HAS NOT BEEN INCLUDED ON THE EXTERIOR ELEVATIONS AS IT HAS NO BEARING ON THE OVERALL BUILDING DESIGN.

FINISH LEGEND - EXTERIOR MATERIALS

UM1
04 2000 UNIT MASONRY
MATERIAL: CLAY MASONRY UNIT
SIZE: MODULAR UNIT
FINISH: SMOOTH
NOTE: PRIMARY FIELD BRICK

UM2
04 2000 UNIT MASONRY
MATERIAL: CLAY MASONRY UNIT
SIZE: MODULAR UNIT
FINISH: SMOOTH
STACK BOND
NOTE: SECONDARY COLOR

MP1
07 4213.2 METAL COMPOSITE MATERIAL
DESCRIPTION: Metal Composite Metal
TYPE: Fire Retardant Core
SIZE: Refer to Sections and Elevations
THICKNESS: 0.157" Material, 2" Panel
STYLE: Route and Return

CW1
08 4413 Glazed Aluminum Curtain Wall
MANUFACTURER: OLDCASTLE BUILDING ENVELOPE
TYPE: RELIANCE-SS CASSETTE
SIZE: 2 1/2" x 8"
NOTE: REFER TO ELEVATIONS FOR GLAZING TYPE

ES1
08 4113 Entrances and Storefronts
MANUFACTURER: OLDCASTLE BUILDING ENVELOPE
TYPE: SERIES 3000 THERMAL MULTIPLANE
SIZE: 2' x 4 1/2"
STYLE: FRONT SET - 1" GLAZING
NOTE: REFER TO ELEVATIONS FOR GLAZING TYPE

GL1
08 8000 Glazing
DESCRIPTION: Heat Strengthened Insulated Glass
MANUFACTURER: Guardian
TYPE: SunGuard SNX 51/23
SIZE: 1" Unit Width
NOTE: Temper as indicated on Elevations

GL1*
08 8000 Glazing
DESCRIPTION: Heat Strengthened Insulated Glass
MANUFACTURER: Guardian
TYPE: SunGuard SNX 51/23
SIZE: 1" Unit Width
Apply Translucent Film on Surface 4
NOTE: Temper as indicated on Elevations

Project:
11SIXTY5
WEAVER
DAIRY

SHELL OFFICE
BUILDING
1165 WEAVER DAIRY
CHAPEL HILL, NC

PIN:
9880350595

NOT ISSUED FOR
CONSTRUCTION

Job Number: 15060

Drawn	SAL
Checked	
Date	01/25/18
Revisions	

SPECIAL USE PERMIT

Sheet Title:
**COMPOSITE
EAST + WEST
ELEVATIONS**

Sheet Number
A205

MHAworks
ARCHITECTURE
PLANNING
INTERIORS
501 WASHINGTON STREET, SUITE G
DURHAM, NORTH CAROLINA 27701
P 919.682.2870
F 919.682.5369
www.mhaworks.com

Coulter
Jewell
Thames RA
111 West Main Street
Durham, N.C. 27701
p 919.682.0368
f 919.682.5646
www.cjtpa.com

NC BOARD OF EXAMINERS FOR
ENGINEERS AND SURVEYORS
LIC # C-1209
NC BOARD OF LANDSCAPE
ARCHITECTS LIC # C-104

ENGINEERING, PLANNING, LANDSCAPE ARCHITECTURE