

# 150 E ROSEMARY STREET & TOWN GREEN

HDC Review

14 September 2021

**PERKINS —  
EASTMAN**

**Surface**

# E ROSEMARY STREET REDEVELOPMENT

UNC/McCorkle Place

136 E Rosemary  
Renovation

**SITE**

125 E Rosemary Parking Deck

150 E Rosemary Lab/Office Building

Town Green

**EXISTING CONTEXT**

**HENDERSON ST**

**E ROSEMARY ST**

**SITE**

**FRANKLIN-ROSEMARY HISTORIC DISTRICT**

**NCNB ALLEY**

**VARSITY ALLEY**

**POST OFFICE ALLEY**

# CONTEXT SITE PLAN

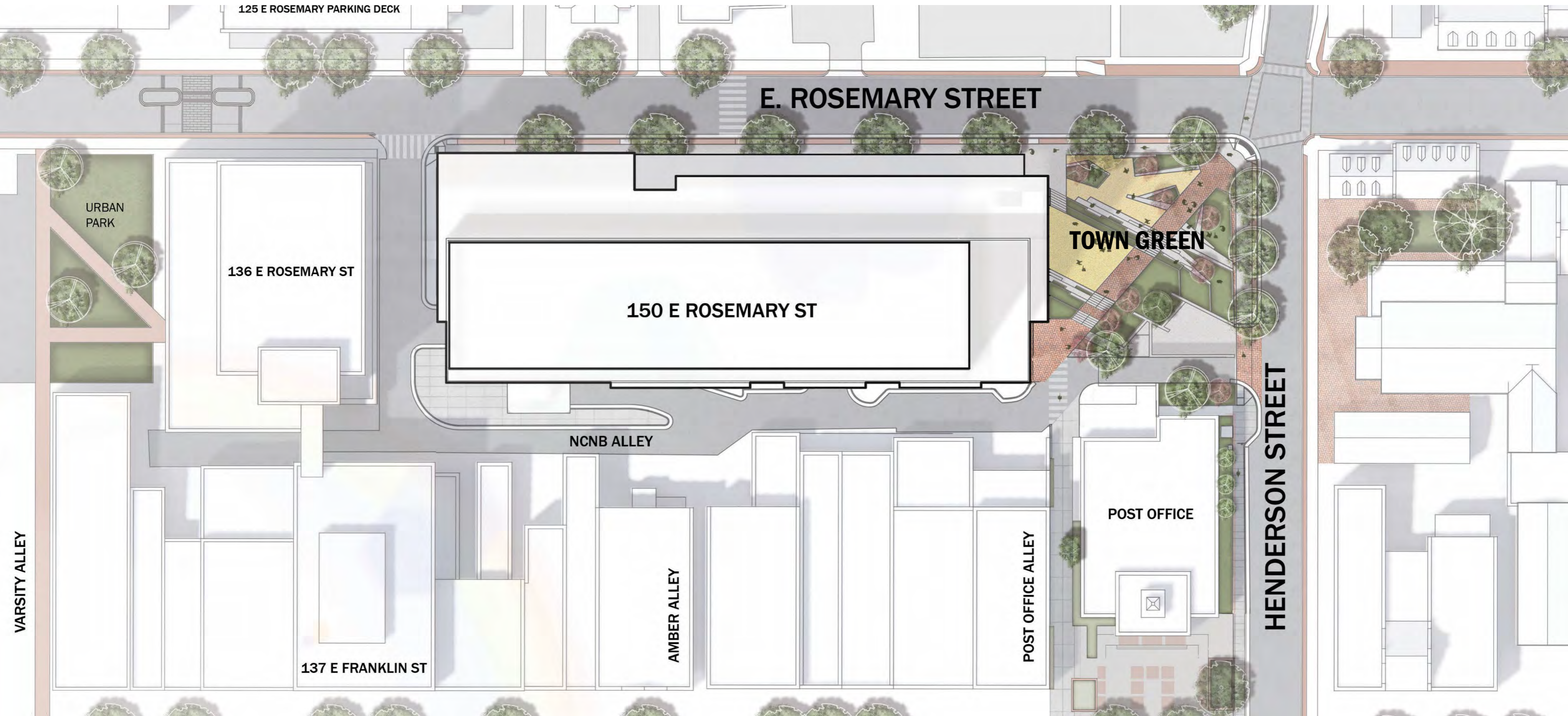

# EXISTING SITE EDGES



**STREET CORNER**



**NCNB ALLEY ENTRANCE**



**POST OFFICE ALLEY VIEW**

# PUBLIC REALM

**E ROSEMARY STREET: WIDENED SIDEWALK & NEW STREET TREES**

**TOWN GREEN: PLANTING AND SEATING**

**HENDERSON STREET: WIDENED SIDEWALK, CURBSIDE PARKING REMOVED**

**NCNB ALLEY: STRAIGHTENED, SERVICE ELEMENTS SCREENED**

**POST OFFICE ALLEY: EXTENDED TO E ROSEMARY AND CORNER**

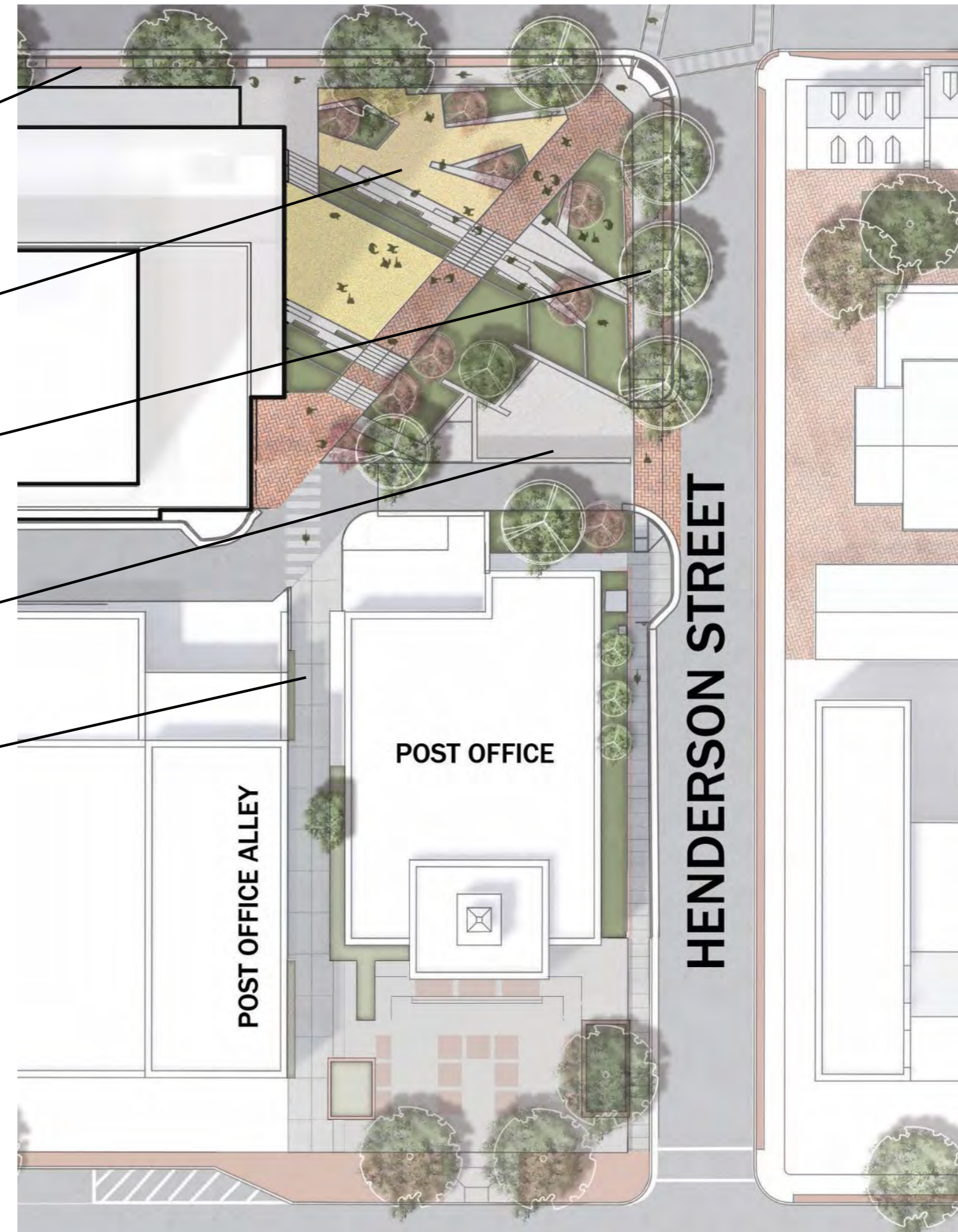

# HISTORIC DISTRICT – MATERIALS PALETTE



**BRICK PAVERS**



**FIELDSTONE WALLS**



**STUCCO/LIMESTONE**

# TOWN GREEN - OWASA EASEMENT

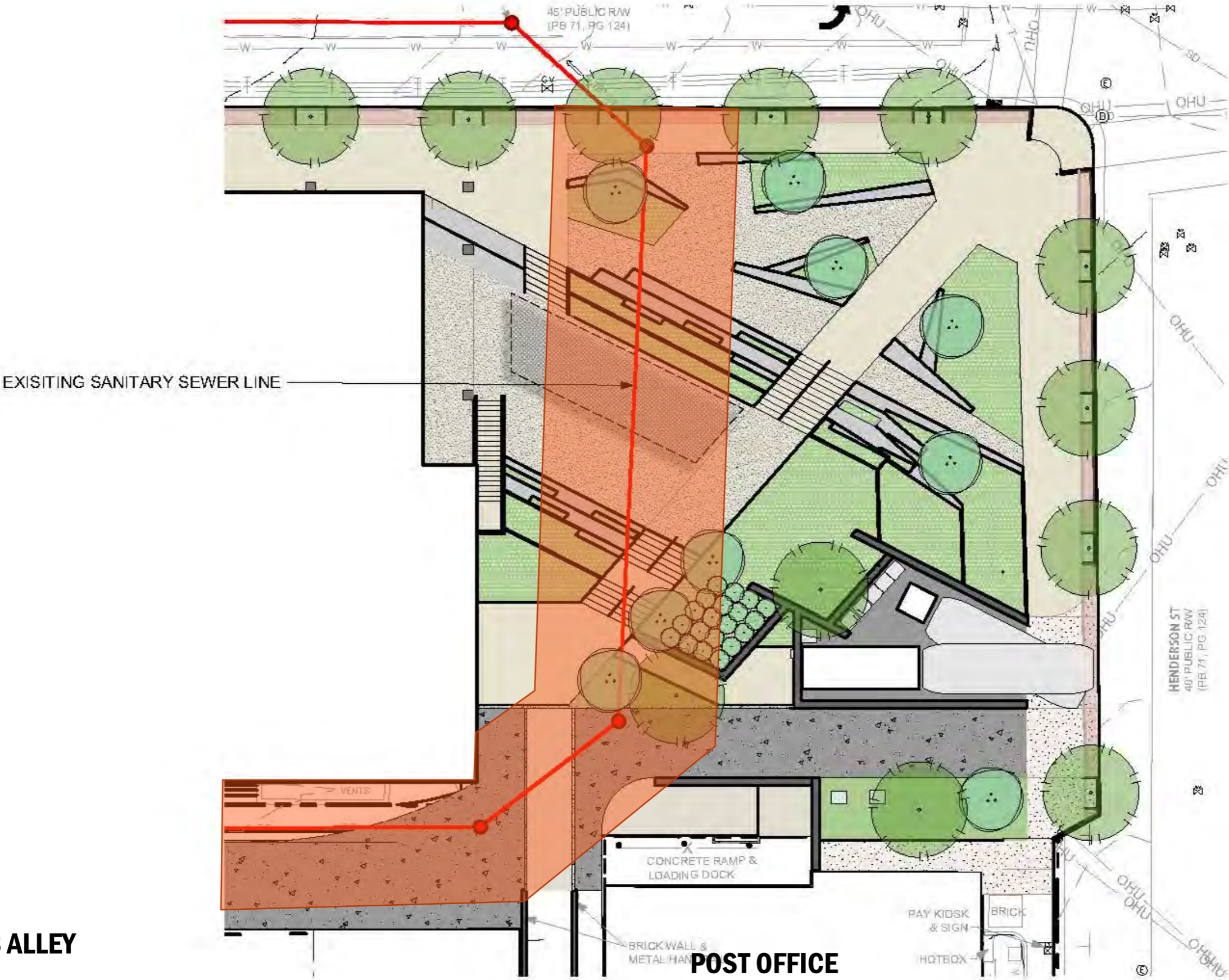



# TOWN GREEN - HARDSCAPE

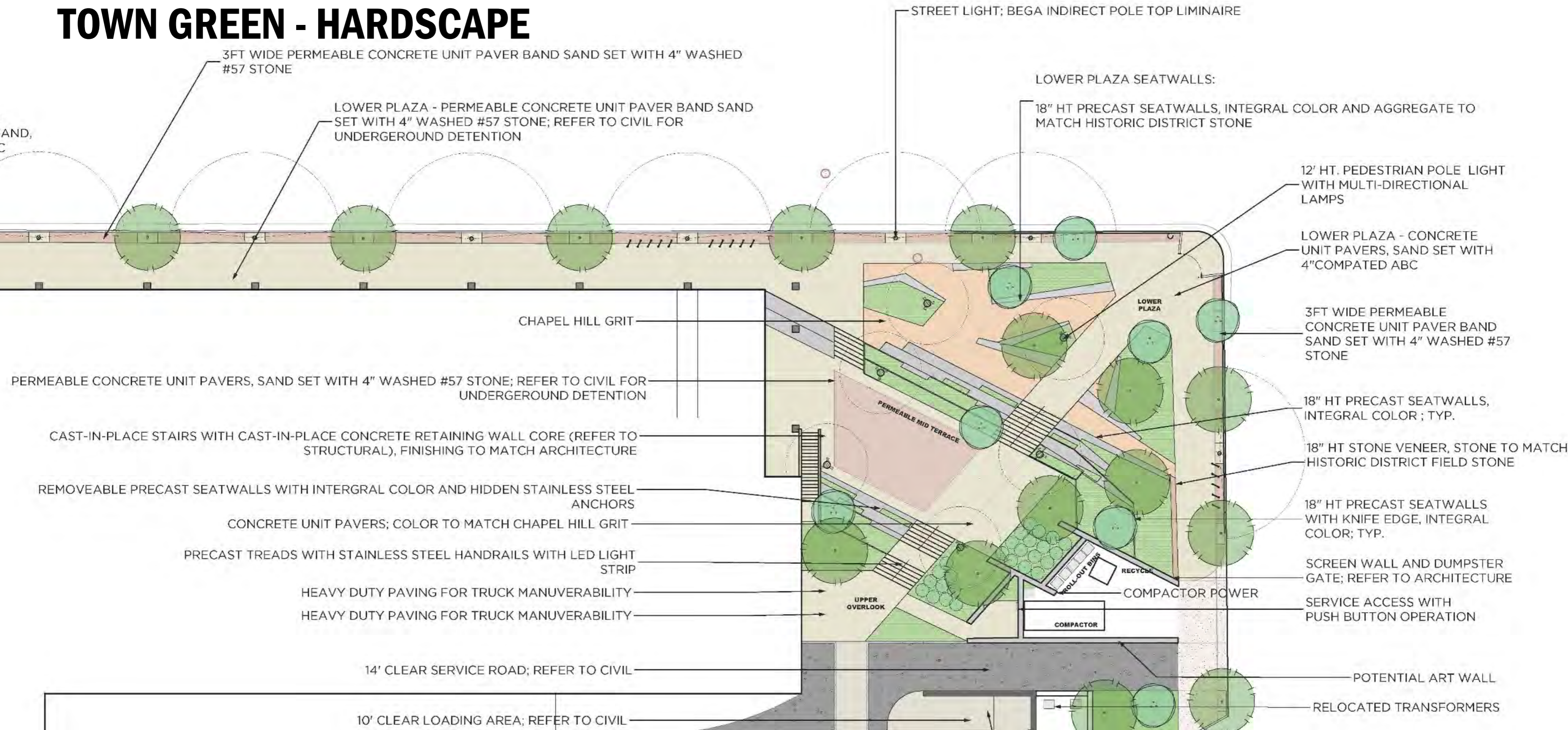

# TOWN GREEN - PLANTING

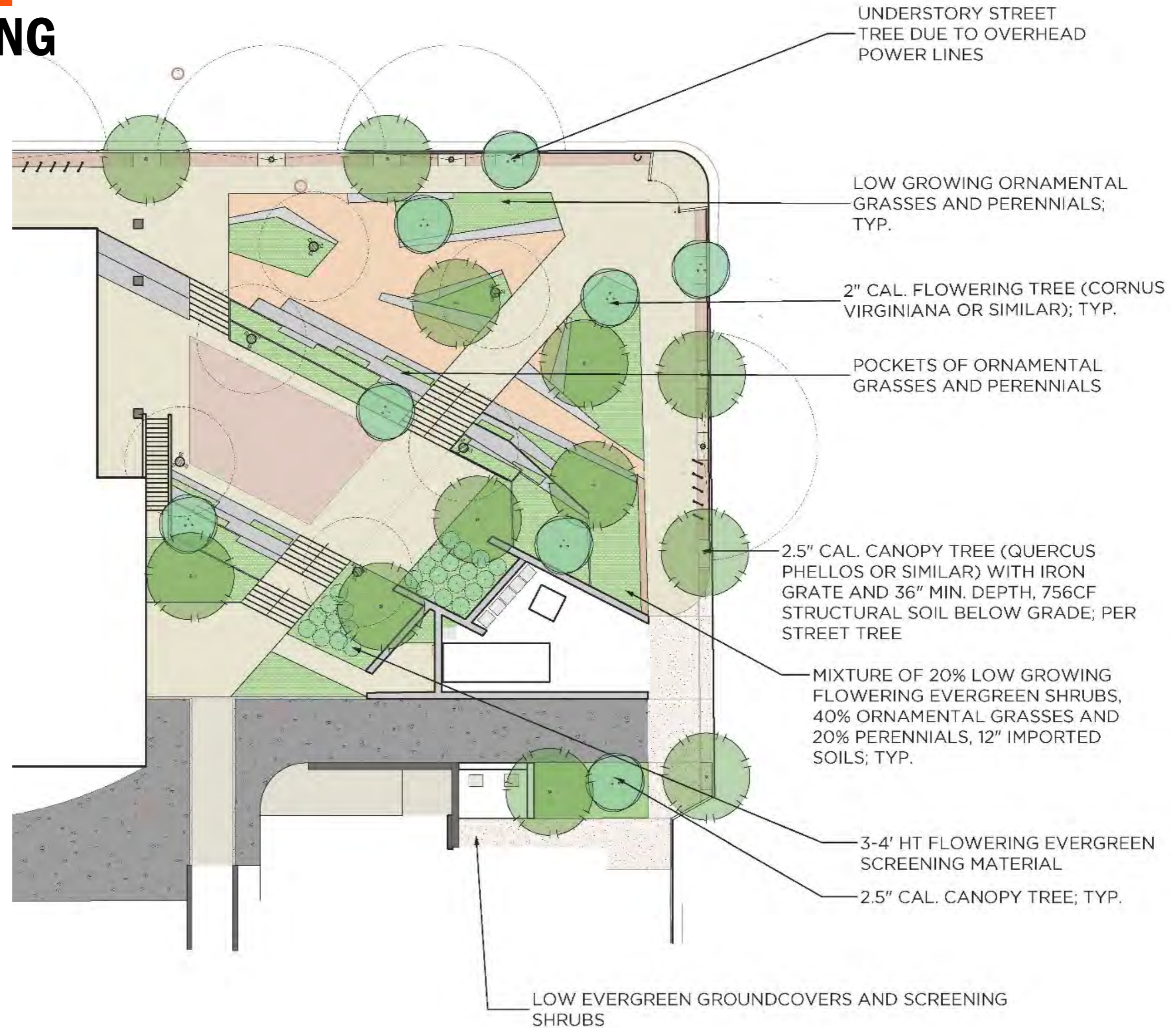

# TOWN GREEN - LIGHTING

STREET; BEGA INDIRECT POLE TOP LUMINARE

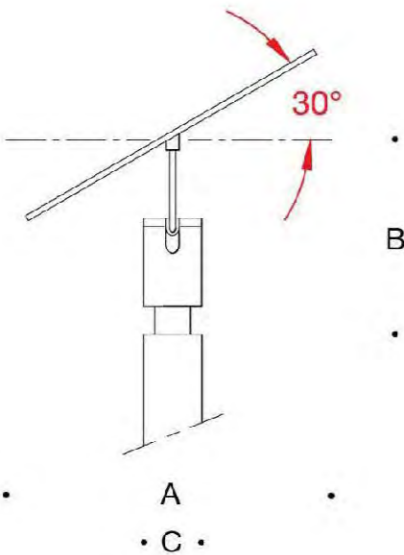

PEDESTRIAN; MULTI-DIRECTIONAL 12' POLE LIGHT

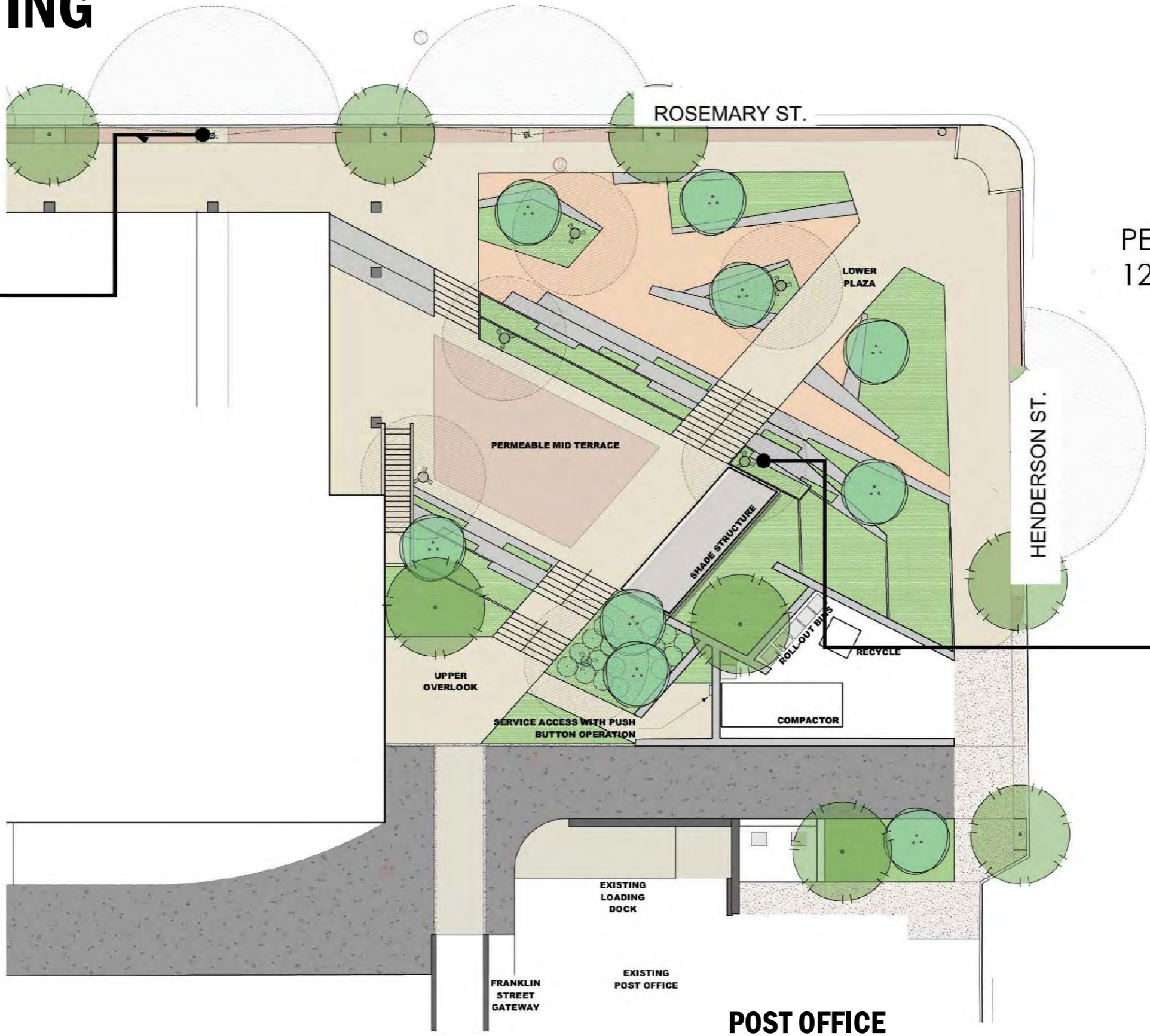

# CORNER - EXISTING



Google Earth  
© 2021 Google

# CORNER - PREVIOUS



# CORNER - UPDATED



# CORNER VIEW - EXISTING



# CORNER VIEW - PREVIOUS





# CORNER VIEW - UPDATED



# MATERIALS

ORNAMENTAL TREES

LIMESTONE FINISH PRECAST SEAT WALLS AND STEPS

CHAPEL HILL GRIT

FIELDSTONE WALLS

LOW PERENNIAL PLANTING

BRICK PAVERS

BRICK PAVERS

# ALLEY DETAIL

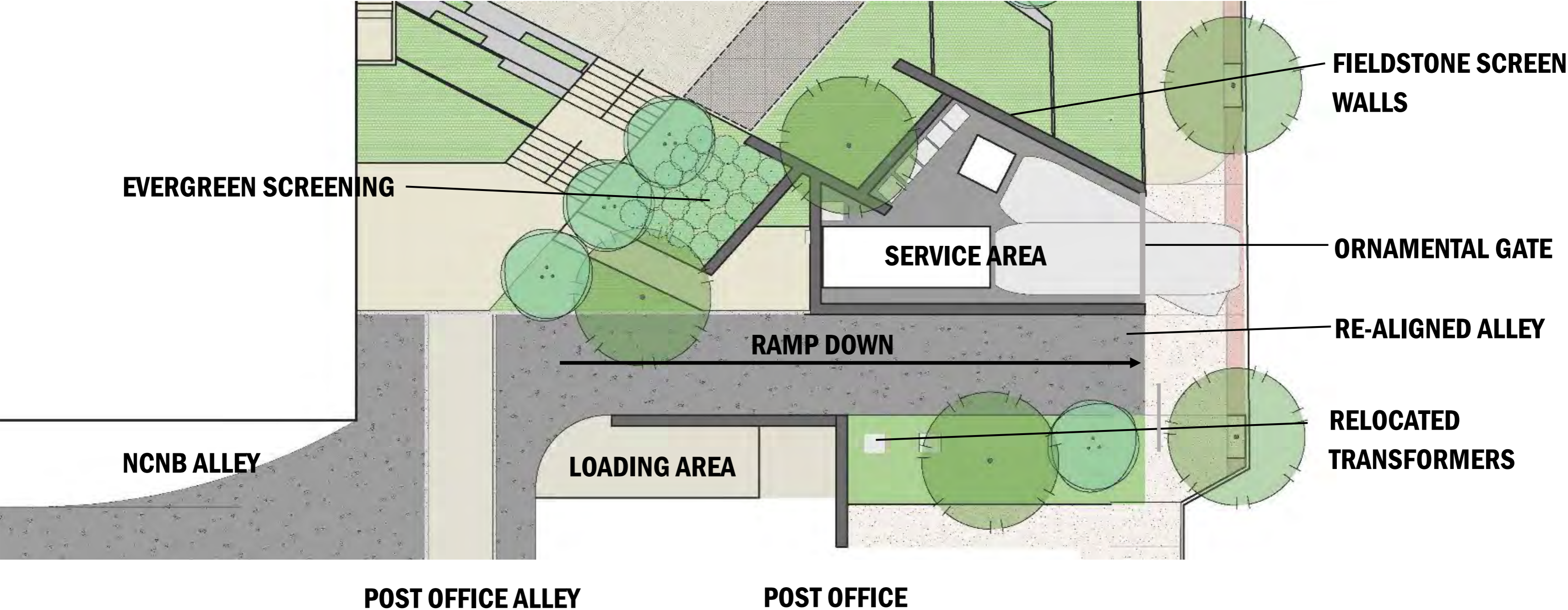

# HENDERSON STREET - EXISTING



# HENDERSON STREET - PREVIOUS



# HENDERSON STREET - GATE ALTERNATE



# HENDERSON STREET - GATE ALTERNATE



# HENDERSON STREET - GATE ALTERNATE





# APPLICABLE DESIGN GUIDELINES

## LIMESTONE FEATURES ON POST OFFICE FACADE



**COPINGS & CORNICES**



**COPINGS & CORNICES**



**SILLS**

# APPLICABLE DESIGN GUIDELINES

## *1.2 Public Rights-of-way (page 45):*

1.2.1. Retain and preserve the topography, materials, site features, and street patterns of the rights-of-way and the dimensions of the streets, alleys, sidewalks, and planting strips, that are important in defining the overall historic character of the districts.

1.2.2. Protect and maintain the details, features, and material surfaces of the historic streetscape—including, but not limited to, red brick and Chapel Hill grit walkways, fieldstone walls, and brick gutters—through a program of regular maintenance and repair using accepted preservation methods.

1.2.7. Locate necessary street furniture, trash receptacles, mailboxes, newspaper racks, and similar elements in locations that do not compromise, but instead complement the historic character of the streetscape. Select benches and other street furniture that are compatible with the historic district in design, scale, and materials.

---

Existing topography of the rights-of-way are will not be altered.

Existing streetscape is being extended with materials and planting strip prevalent in the vicinity.

Brick pavers, Chapel Hill grit and fieldstone walls will be used.

Street furniture will complement the historic district in character.

---

# APPLICABLE DESIGN GUIDELINES

## 1.3 Walls & Fences (pages 48-49)

1.3.6. Site new walls and fences in configurations and locations that are compatible with the character of the building, site, and district and consistent with the location and height of other walls and fences in the district.

1.3.7. Construct new walls using traditional materials and designs that are compatible in configuration, height, material, scale, and detail with the character of the building, site, and district.

1.3.8. Construct new front- and side-yard fences using traditional materials and designs that are compatible in configuration, height, material, scale, and detail with the character of the building, site, and district.

1.3.9. Introduce contemporary utilitarian walls and fences in rear yards only where they do not compromise the historic character of the building, site, or district.

---

**New seat walls will be approximately 18” high and will be precast concrete with a limestone color and finish.**

**The screen walls for the service area will be built with fieldstone, and will be segmented with small sections that follow the topography of the Town Green.**

**Fieldstone screen walls will be planted with climbing plants.**

# APPLICABLE DESIGN GUIDELINES

## *1.4 Walkways, Driveways, & Off-Street Parking (pages 52-53)*

1.4.5. Design new walkways, driveways, and off-street parking to conform with the spacing, width, configuration, and materials of character-defining walkways, driveways, and off-street parking areas in the district.

1.4.6. Site new walkways, driveways, and off-street parking areas in locations that are compatible with the character of the building, site, and district—typically to the side and rear of existing buildings—and locate them so the topography of the site and mature trees and other significant site features are not significantly altered, damaged, or lost.

- b. In commercial and institutional areas, parking should be located at the side or rear of the property whenever possible.

---

**New walkways will be consistent in dimension and character with the historic district.**

**New parking is located along NCNB alley, outside of the historic district boundary.**

# APPLICABLE DESIGN GUIDELINES

1.4.9. Construct new walkways in traditional materials and designs that are compatible in configuration, material, scale, and detail with the character of the building, site, and district. a. These include red brick, flagstone, concrete, and Chapel Hill grit. b. Do not use asphalt or contemporary materials that mimic other materials for sidewalks within the historic districts.

1.4.11. Utilize perimeter plantings, trees, shrubbery, hedges, and other landscape features—including low stone walls—to screen new driveways and off-street parking areas visually from the street, to buffer adjacent residential properties from their visual impact, and to reduce the solar heat gain of paved surfaces. Further reduce the visual impact of large parking areas by subdividing them with interior planting medians.

---

**New walkways will use brick, concrete and Chapel Hill grit.**

**The eastern extension of NCNB alley will be screened by fieldstone walls.**

**Parking spaces will be located on NCNB alley outside of the historic district boundary and not visible from Henderson or E Rosemary Streets.**

# THANK YOU